

M616x Series

5 x 7 mm, 3.0, 3.3 & 5.0 Volt, HCMOS or Clipped Sinewave,
Precision TCXO/TCVCXO

Product Features

- Tight stability performance
(+/-0.2 ppm) over Industrial Temperatures (-40°C to +85°C)
(+/-0.10 ppm) over Commercial Temperatures (0°C to 70°C)
- Available in 10 pad and 14 DIP configurations (Contact factory for 14 DIP)
- 3.0 V, 3.3 V and 5.0 V versions
- Low phase noise performance
- Tri-state Function standard
- Low G-sensitivity (0.6 ppb/G) version available



Product Description

MtronPTI's M616x Series TCXO's and TCVCXO's provide design engineers with low voltage, surface mount products with extremely tight stability (to 0.10 ppm) over temperature and time. Specially processed crystals enable the M616x to achieve consistent long-term stability and minimal frequency shift after reflow. This processing also achieves excellent g-sensitivity (0.6 ppb/g). The low phase noise (-155 dBc/Hz at 100 kHz) makes the M616x ideal for the design engineer working on all types of systems as the reference timing source. Ten pad SMT and 14-pin DIP compatible versions available.

Product Applications

The M616x Series is ideally suited for a wide range of applications such as GPS, military, avionics, test and measurement, WLAN, WiMax base stations, point to point/multi-point radios, medical equipment, frequency synthesis, frequency translation and land mobile radio. Standard output for the M616x series is HCMOS compatible or clipped sinewave. The product is ideally suited for battery and remote applications where it draws as little as 1.5 mA of current with a 3.3 volt supply at 13 MHz. This low power consumption provides an advantage over similarly specified ovenized oscillators for power-sensitive applications. The M616x series offers ± 9.2 ppm minimum pull range with excellent tuning linearity performance for critical PLL applications. This series is available in frequencies from 8 to 40MHz and selective frequencies up to 52 MHz.

Product Ordering Information

Ordering Information		M616x	1	J	T	C	T	00.0000 MHz	
Product Series									
M6160: 5.0 V									
M6161: 3.3 V									
M6162: 3.0 V									
M6163: 5.0 V Low G									
M6164: 3.3 V Low G									
M6165: 3.0 V Low G									
Temperature Range									
1: 0°C to +70°C		8: 0°C to +50°C							
2: -40°C to +85°C		F: -30°C to +75°C							
6: -20°C to +70°C									
Stability									
L: ± 4.6 ppm		J: ± 1.0 ppm		M: ± 0.2 ppm					
H: ± 2.5 ppm		G: ± 0.5 ppm		Q: ± 0.14 ppm					
K: ± 2.0 ppm		P: ± 0.3 ppm		N: ± 0.10 ppm					
Output Type									
T: Voltage Controlled With Tristate									
F: No Voltage Control With Tristate									
Output Waveform									
C: HCMOS									
S: Clipped Sine Wave									
Package/Lead Configurations									
N: 10 Pad Leadless Ceramic		D: 14 DIP							
Frequency (customer specified)									

M6160Sxxx, M6161Sxxx, M6162Sxxx, M6163Sxxx, M6164Sxxx &
M6165Sxxx - Contact factory for datasheets.

M616x Series

5 x 7 mm, 3.0, 3.3 & 5.0 Volt, HCMOS or Clipped Sinewave,
Precision TCXO/TCVCXO

Performance Characteristics

Parameter	Symbol	Min.	Typ.	Max.	Units	Conditions/Notes
Frequency Range	F_0	8		52	MHz	Contact factory above 40 MHz
Operating Temperature	T_A	-40		+85	°C	See Ordering Information
Storage Temperature	T_{STG}	-55		+125	°C	
Frequency Tolerance @ +25°C		-1.0		+1.0	ppm	For TCXO only
Frequency Stability		See Ordering Information				($F_{max} - F_{min}$)/2
Stability Vs. Reflow		-1.0		+1.0	ppm	
Frequency Vs. Supply			±0.02	±0.1	ppm	For 5% supply voltage variation
Frequency Vs. Load			±0.02	±0.1	ppm	For 5% load variation
Aging (First Year)		-1.0		+1.0	ppm	$F_0 \leq 20$ MHz
Aging (First Year)		-2.0		+2.0	ppm	$F_0 > 20$ MHz
Aging (10 Year)		-3.0		+3.0	ppm	$F_0 \leq 20$ MHz (Includes first year)
Aging (10 Year)		-5.0		+5.0	ppm	$F_0 > 20$ MHz (Includes first year)
Supply Voltage Tolerance		-5.0		+5.0	%	See Ordering Information
Supply Current (I_D)		2.0		3.0	mA	HCMOS output at 13 MHz
		3.0		4.0	mA	HCMOS output at 26 MHz
		5.5		6.5	mA	HCMOS output at 52 MHz
		1.3		1.9	mA	Clipped sinewave output at 13 MHz
		1.7		2.3	mA	Clipped sinewave output at 26 MHz
		2.8		3.5	mA	Clipped sinewave output at 52 MHz
Output Logic Levels (HCMOS)	V_{OL} V_{OH}			20	% V_S % V_S	$I_{OH}/I_{OL} = \pm 4$ mA, $V_S = +3.0$ V $I_{OH}/I_{OL} = \pm 4$ mA, $V_S = +3.0$ V
Output Level (Clipped Sinewave)		1.0			V_{pk-pk} V_{pk-pk}	$F_0 \leq 40$ MHz $F_0 > 40$ MHz
Waveform Symmetry		40		60	%	Ref. to $\frac{1}{2} V_S$. HCMOS only
Rise/Fall Time				6.5	ns	Ref. 10% to 90%. HCMOS only
Output Load			15 10/10		pF Kohm/pF	HCMOS output Clipped sinewave output
Frequency Adjustment		-5.0		+5.0	ppm	Over Control Voltage Range
G-Sensitivity			0.6		ppb/g	
Control Voltage Range		0.3		2.7	Volts	For $V_S = 3.0$
		0.3		3.0	Volts	For $V_S = 3.3$
		0.5		4.5	Volts	For $V_S = 5.0$
Input Leakage Current		-50		+50	µA	
Input Resistance		100			Kohm	
Linearity				5	%	
Modulation Bandwidth		2 kHz				
Tristate Function		70			% V_S	Output enabled. Logic "1" or "Open"
				30	% V_S	Output disabled. Logic "0" or "GND"
Tristate Leakage Current		-100		+100	µA	
Phase Noise (Typical 20 MHz CMOS)			-98		dBc/Hz	10 Hz Offset
			-125		dBc/Hz	100 Hz Offset
			-145		dBc/Hz	1 KHz Offset
			-154		dBc/Hz	10 KHz Offset
			-156		dBc/Hz	100 kHz Offset
Environmental	Shock	MIL-STD-202, Method 213, Condition C				100 g
	Vibration	MIL-STD-202, Methods 201 & 204				10 g from 10 to 2000 Hz
	Solderability	EIAJ-STD-002				
	Package	5.0 x 7.0 mm, SMT and DIP				RoHS Compliant
	Max Soldering Conditions	See solder profile				

M616x Series

5 x 7 mm, 3.0, 3.3 & 5.0 Volt, HCMOS or Clipped Sinewave, Precision TCXO/TCVCXO

Phase Noise Plot

M616x 20 MHz Phase Noise

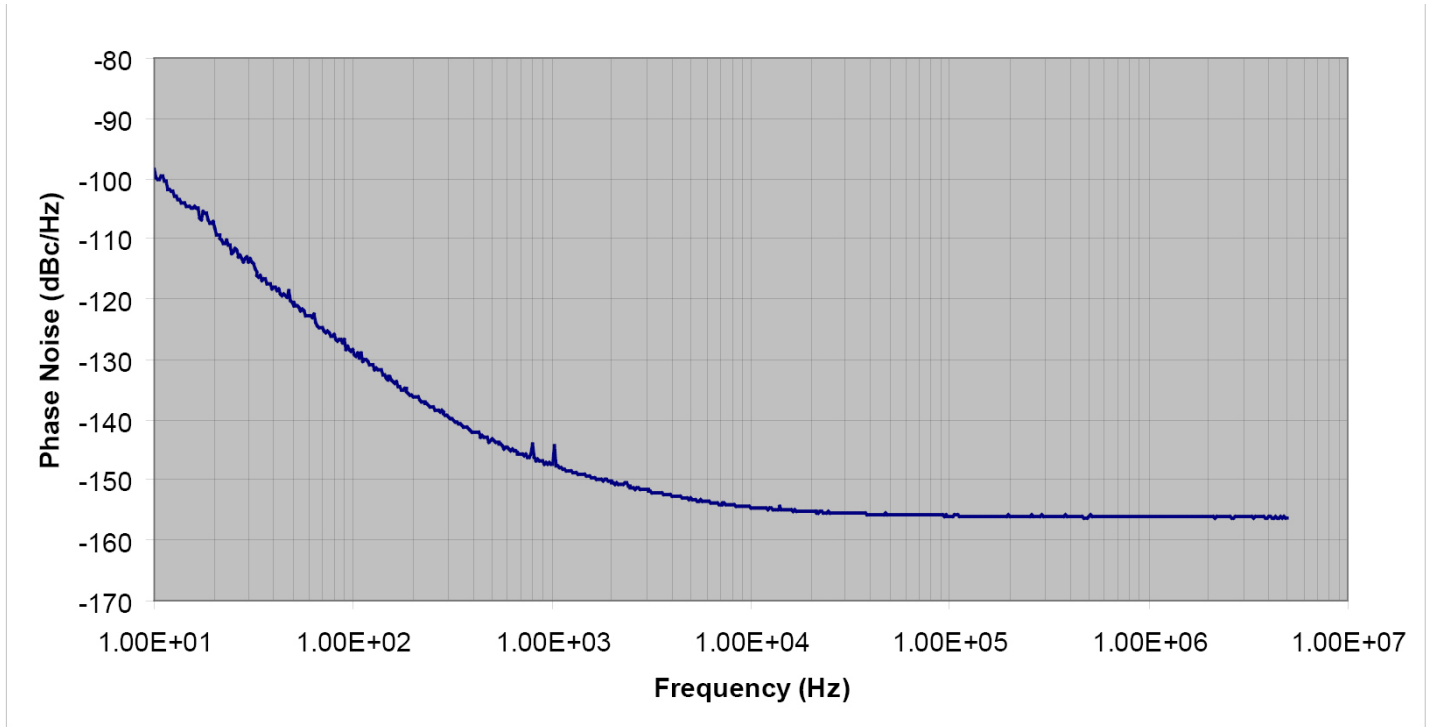

Output Waveform (HCMOS Output)

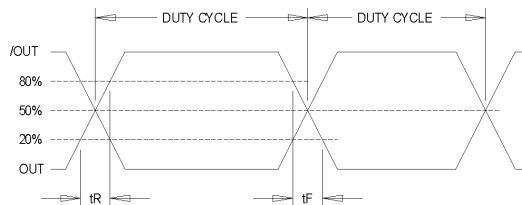

M616x Series

5 x 7 mm, 3.0, 3.3 & 5.0 Volt, HCMOS or Clipped Sinewave,
Precision TCXO/TCVCXO

Product Dimension & Pinout Information - Package Code N (10 Pad)

Pin Connections	
Function	Pad
N/C - Do Not Connect	1
N/C - Do Not Connect	2
N/C - Do Not Connect	3
Ground	4
Output	5
N/C - Do Not Connect	6
N/C - Do Not Connect	7
Tristate	8
Supply Voltage (V_s)	9
Control Voltage	10

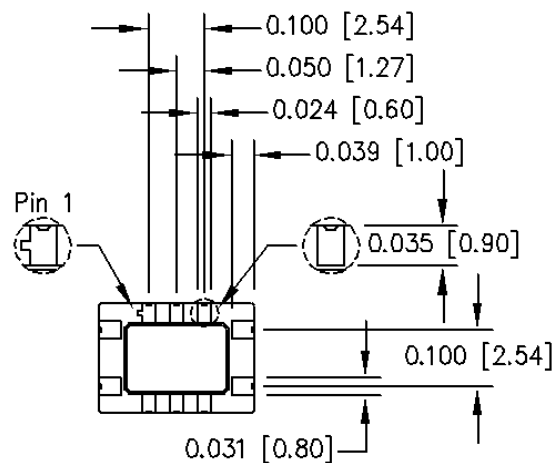
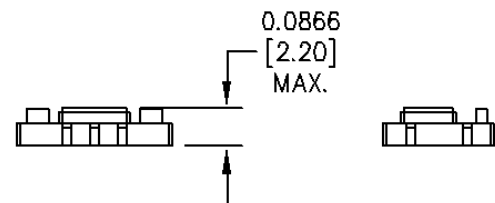
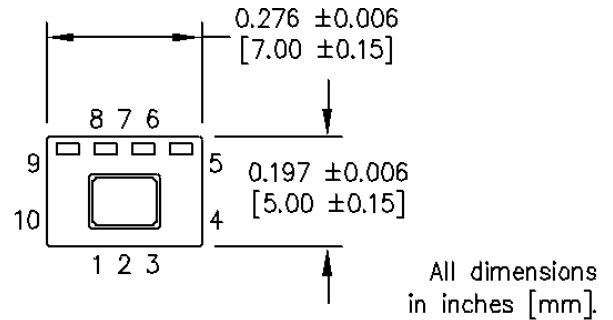

SUGGESTED SOLDER PAD LAYOUT

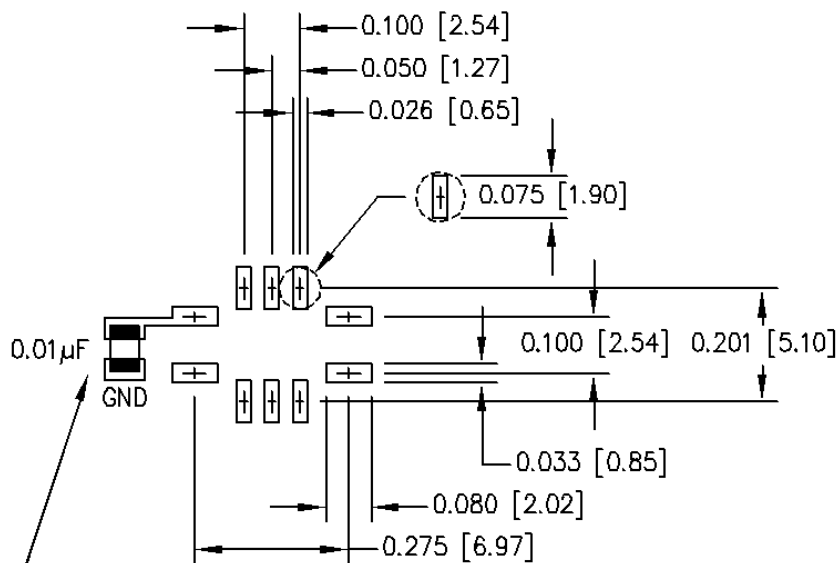

Optional bypass capacitor.
Device is internally bypassed.

Handling Information

Although protection circuitry has been designed into the M616x oscillator, proper precautions should be taken to avoid exposure to electrostatic discharge (ESD) during handling and mounting. MtronPTI utilizes a human-body model (HBM) and a charged-device model (CDM) for ESD-susceptibility testing and protection design evaluation. ESD voltage thresholds are dependent on the circuit parameters used to define the mode. Although no industry-wide standard has been adopted for the CDM, a standard HBM (resistance = 1500 Ω , capacitance = 100 pF) is widely used and therefore can be used for comparison purposes. The HBM ESD threshold presented here was obtained using these circuit parameters.

Model	ESD Threshold, Minimum	Unit
Human Body	1500*	V
Charged Device	1500*	V

* MIL-STD-833D, Method 3015, Class 1



ATTENTION
Static Sensitive
Devices
Handle only at
Static Safe Work
Stations

Typical Test Circuits

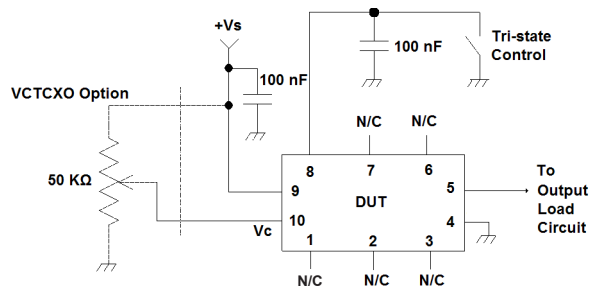

Test Circuit - N Package
With Tri-State

M616x Series

5 x 7 mm, 3.0, 3.3 & 5.0 Volt, HCMOS or Clipped Sinewave,
Precision TCXO/TCVCXO

Tape & Reel Specifications

(all measurements are in mm)	A	B	C	D	E	F	G	H	J	K	L	M	N
M616x	5.40	7.40	1.55	7.50	2.60	2.00	4.00	16.00	330	13.00	20.20	100	16.40

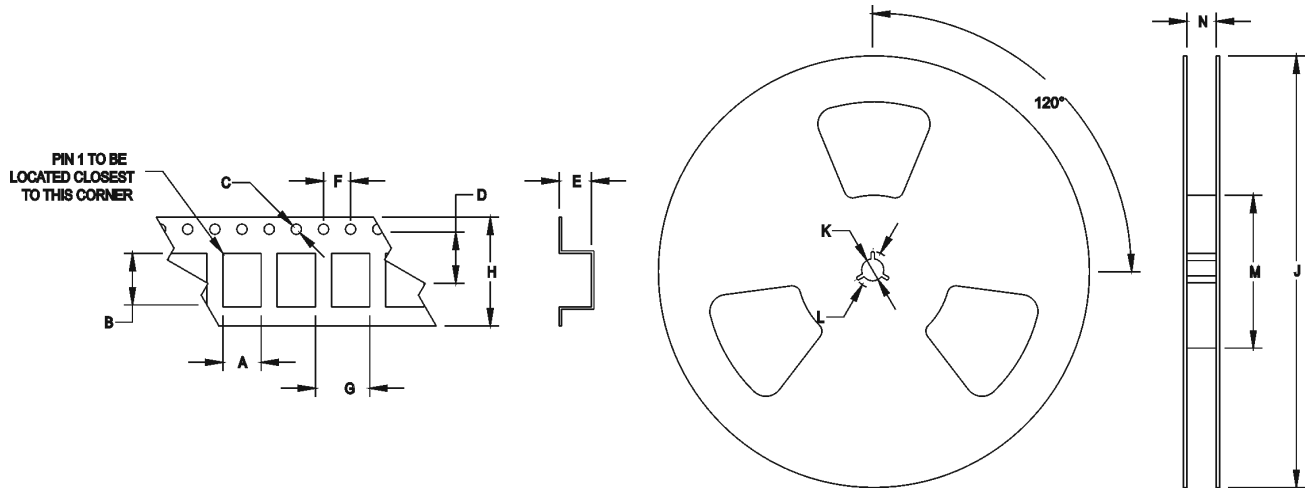

Standard Tape and Reel: 1000 parts per reel

Maximum Soldering Conditions

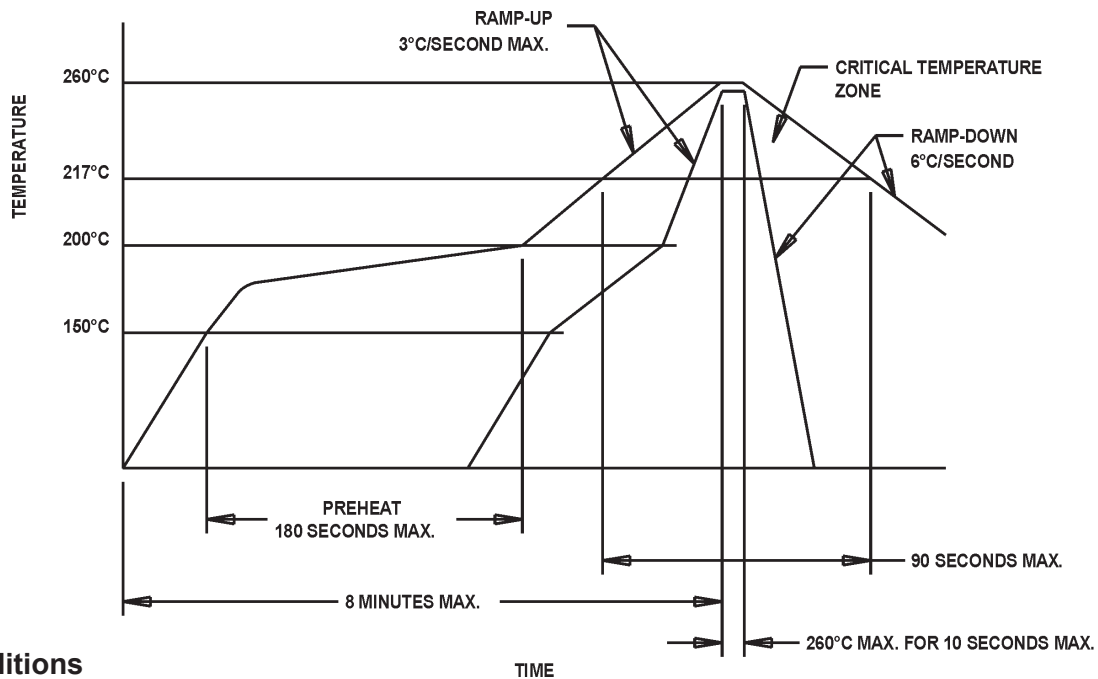

Solder Conditions

Note: Exceeding these limits may damage the device.

M616x Series

5 x 7 mm, 3.0, 3.3 & 5.0 Volt, HCMOS or Clipped Sinewave,
Precision TCXO/TCVCXO

Quality Parameters

Environmental Specifications/Qualification Testing Performed on the M616x TCXO/TCVCXO		
Test	Test Method	Test Condition
Electrical Characteristics	Internal Specification	Per Specification
Frequency vs. Temperature	Internal Specification	Per Specification
Mechanical Shock	MIL-STD-202, Method 213, C	100 g, 6 ms
Vibration	MIL-STD-202, Method 201-204	10 g from 10-2000 Hz
Thermal Cycle	MIL-STD-883, Method 1010, B	-55 Deg. C to +125 Deg. C, 15 minute Dwell, 10 cycles
Aging	Internal Specification	168 Hours at 105 Degrees C
Gross Leak	MIL-STD-202, Method 112	30 Second Immersion (Crystal Only)
Fine Leak	MIL-STD-202, Method 112	Must meet 1×10^{-8} (Crystal Only)
Solderability	MIL-STD-883, Method 2003	8 Hour Steam Age – Must Exhibit 95% coverage
Resistance to Solvents	MIL-STD-883, Method 2015	Three 1 minute soaks
Physical Dimensions	MIL-STD-883, Method 2016	Per Specification
Internal Visual	Internal Specification	Per Internal Specification

Load Circuit

Load Circuit #2 - HCMOS Output

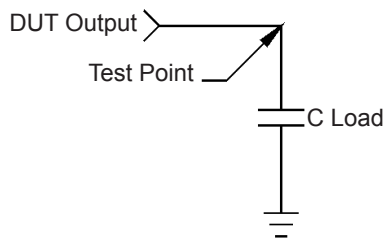

Note: C Load includes probe and fixturing.

Load Circuit #7 - Clipped Sinewave Output

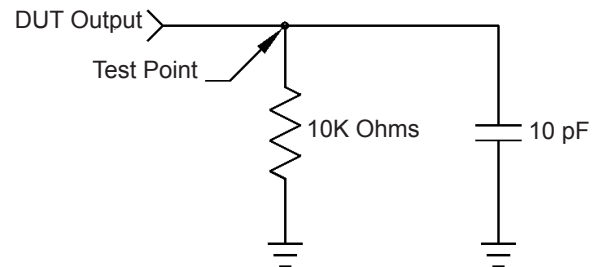

Product Revision Table

Date	Revision	PCN Number	Details of Revision

For custom products or additional specifications contact our sales team at
800.762.8800 (toll free) or 605.665.9321

For more information on this product visit the MtronPTI website at
www.mtronpti.com