

FEATURES

Conversion loss: 7.5 dB typical at 5.5 GHz to 10 GHz
Local oscillator (LO) to radio frequency (RF) isolation: 45 dB typical at 5.5 GHz to 10 GHz
LO to intermediate frequency (IF) isolation: 45 dB typical at 10 GHz to 14 GHz
Input third-order intercept (IIP3): 21 dBm typical at 10 GHz to 14 GHz
Input P1dB: 11.5 dBm typical at 10 GHz to 14 GHz
Input second-order intercept (IIP2): 55 dBm typical at 10 GHz to 14 GHz
Passive double-balanced topology
Wide IF bandwidth: dc to 6 GHz
12-lead ceramic leadless chip carrier package

APPLICATIONS

Point to point microwave radios
Point to multipoint radios
Military end use
Instrumentation, automatic test equipment (ATE), and sensors

GENERAL DESCRIPTION

The [HMC558A](#) is a general-purpose, double-balanced mixer in a leadless RoHS compliant SMT package that can be used as an upconverter or downconverter between 5.5 GHz and 14 GHz. This mixer is fabricated in a gallium arsenide (GaAs) metal semiconductor field effect transistor (MESFET) process, and requires no external components or matching circuitry.

FUNCTIONAL BLOCK DIAGRAM

Figure 1.

The [HMC558A](#) provides excellent LO to RF and LO to IF isolation due to optimized balun structures, and operates with LO drive levels as low as 9 dBm. The RoHS compliant [HMC558A](#) eliminates the need for wire bonding, and is compatible with high volume surface-mount manufacturing techniques.

TABLE OF CONTENTS

Features	1	Downconverter Performance	6
Applications.....	1	Upconverter Performance.....	9
Functional Block Diagram	1	Return Loss and Isolation Performance.....	10
General Description	1	Spurious Performance	12
Revision History	2	Theory of Operation	13
Specifications.....	3	Applications Information	14
Absolute Maximum Ratings.....	4	Typical Application Circuit.....	14
Thermal Resistance	4	Evaluation Board Information	14
ESD Caution.....	4	Outline Dimensions	15
Pin Configuration and Function Descriptions.....	5	Ordering Guide	15
Interface Schematics.....	5		
Typical Performance Characteristics	6		

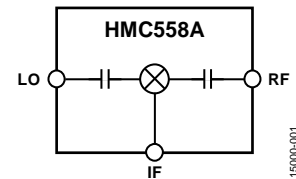
REVISION HISTORY

11/2016—Revision 0: Initial Version

SPECIFICATIONS

LO drive level = 15 dBm, $T_A = 25^\circ\text{C}$, IF = 100 MHz, upper sideband, unless otherwise noted. All measurements performed as a downconverter.

Table 1.

Parameter	Min	Typ	Max	Unit
RF FREQUENCY RANGE	5.5		14	GHz
LO FREQUENCY RANGE	5.5		14	GHz
LO DRIVE LEVEL		15		dBm
IF FREQUENCY RANGE	DC		6	GHz
PERFORMANCE AT RF = 5.5 GHz to 10 GHz				
Conversion Loss		7.5	9.5	dB
Single Sideband (SSB) Noise Figure		7.5		dB
Input Third-Order Intercept (IIP3)	15	17.5		dBm
Input 1 dB Compression Point (IP1dB)		10		dBm
Input Second-Order Intercept (IIP2)		50		dB
RF to IF Isolation	8	16		dB
LO to RF Isolation	35	45		dB
LO to IF Isolation	20	35		dB
PERFORMANCE AT RF = 10 GHz to 14 GHz				
Conversion Loss		8.5	10	dB
SSB Noise Figure		10		dB
IIP3	16	21		dBm
IP1dB		11.5		dBm
IIP2		55		dB
RF to IF Isolation	10	19		dB
LO to RF Isolation	30	40		dB
LO to IF Isolation	20	45		dB

ABSOLUTE MAXIMUM RATINGS

Table 2.

Parameter	Rating
RF Input Power	25 dBm
LO Input Power	25 dBm
IF Input Power	25 dBm
IF Source/Sink Current	3 mA
Maximum Junction Temperature	175°C
Continuous P _{DISS} (T = 85°C) (Derate 5.5 mW/°C Above 85°C)	495 mW
Operating Temperature Range	–40°C to +85°C
Storage Temperature Range	–65°C to +150°C
Lead Temperature Range (Soldering 60 sec)	–65°C to +150°C
Electrostatic Discharge (ESD) Sensitivity	
Human Body Model (HBM)	2500 V (Class 2)
Field Induced Charged Device Model (FICDM)	1000 V (Class C5)

Stresses at or above those listed under Absolute Maximum Ratings may cause permanent damage to the product. This is a stress rating only; functional operation of the product at these or any other conditions above those indicated in the operational section of this specification is not implied. Operation beyond the maximum operating conditions for extended periods may affect product reliability.

THERMAL RESISTANCE

Thermal performance is directly linked to printed circuit board (PCB) design and operating environment. Careful attention to PCB thermal design is required.

Table 3. Thermal Resistance

Package Type	θ_{JC}	Unit
E-12-1 ¹	180	°C/W

¹ See JEDEC standard JESD51-2 for additional information on optimizing the thermal impedance (PCB with 3 × 3 vias).

ESD CAUTION



ESD (electrostatic discharge) sensitive device. Charged devices and circuit boards can discharge without detection. Although this product features patented or proprietary protection circuitry, damage may occur on devices subjected to high energy ESD. Therefore, proper ESD precautions should be taken to avoid performance degradation or loss of functionality.

PIN CONFIGURATION AND FUNCTION DESCRIPTIONS

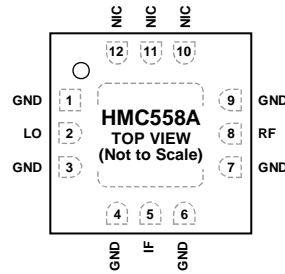

NOTES
 1. NIC = NO INTERNAL CONNECTION.
 2. EXPOSED PAD. CONNECT THE EXPOSED PAD TO A LOW IMPEDANCE THERMAL AND ELECTRICAL GROUND PLANE.

15000-002

Figure 2. Pin Configuration

Table 4. Pin Function Descriptions

Pin No.	Mnemonic	Description
1, 3, 4, 6, 7, 9	GND	Ground. See Figure 6 for the ground interface schematic.
2	LO	Local Oscillator Port. This pin is ac-coupled and matched to 50 Ω. See Figure 4 for the LO interface schematic.
5	IF	DC-Coupled IF. For applications not requiring operation to dc, dc block this port externally using a series capacitor whose value is chosen to pass the necessary IF frequency range. For operation to dc, this pin must not source or sink more than 3 mA of current, or device nonfunction and possible device failure may result. See Figure 5 for the IF interface schematic.
8	RF	RF Port. This pin is ac-coupled internally and matched to 50 Ω. See Figure 3 for the RF interface schematic.
10, 11, 12	NIC EPAD	No Internal Connection. These pins can be grounded. Exposed Pad. Connect the exposed pad to a low impedance thermal and electrical ground plane.

INTERFACE SCHEMATICS

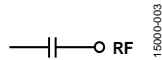

Figure 3. RF Interface

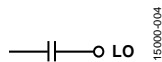

Figure 4. LO Interface

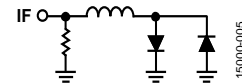

Figure 5. IF Interface



Figure 6. Ground Interface

TYPICAL PERFORMANCE CHARACTERISTICS

DOWNCONVERTER PERFORMANCE

Data taken as downconverter, upper sideband (low-side LO), $T_A = 25^\circ\text{C}$, LO drive level = 15 dBm unless otherwise specified.

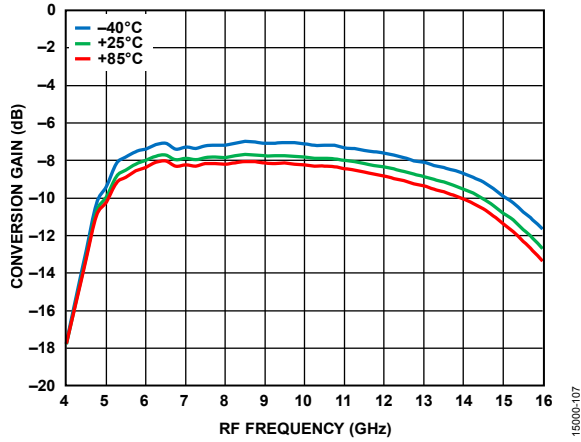

Figure 7. Conversion Gain vs. RF Frequency at Various Temperatures, IF = 100 MHz

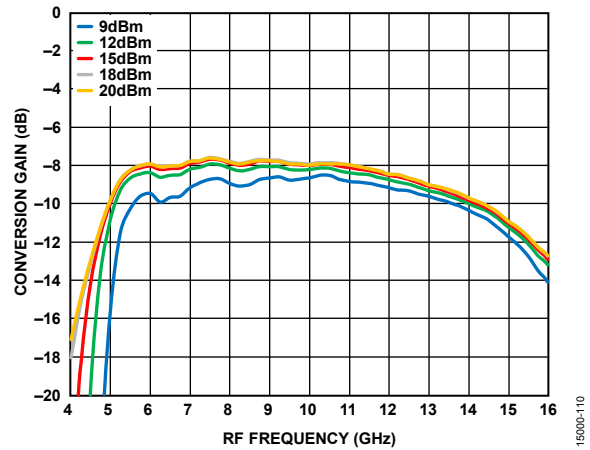

Figure 10. Conversion Gain vs. RF Frequency at Various LO Powers, IF = 100 MHz

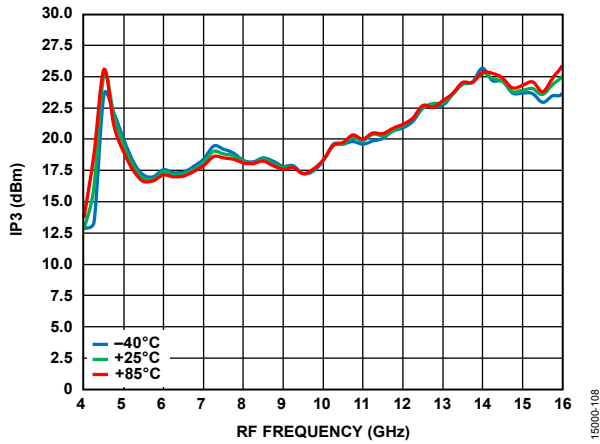

Figure 8. Input IP3 vs. RF Frequency at Various Temperatures, IF = 100 MHz

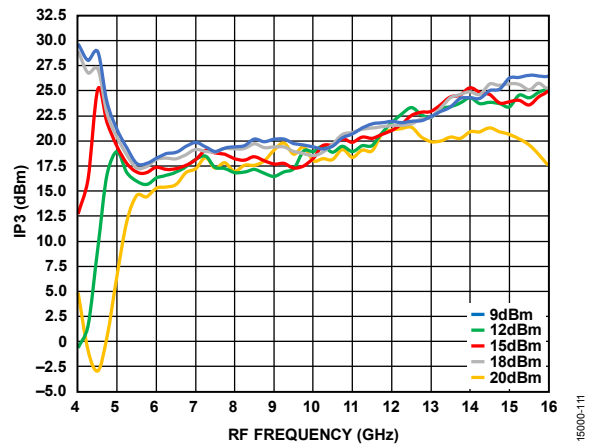

Figure 11. Input IP3 vs. RF Frequency at Various LO Powers, IF = 100 MHz

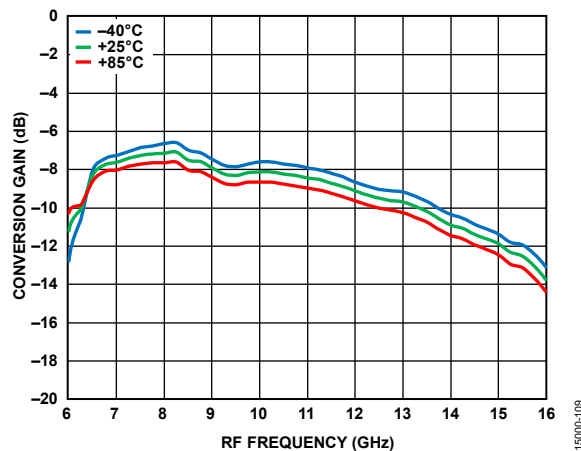

Figure 9. Conversion Gain vs. RF Frequency at Various Temperatures, IF = 2 GHz

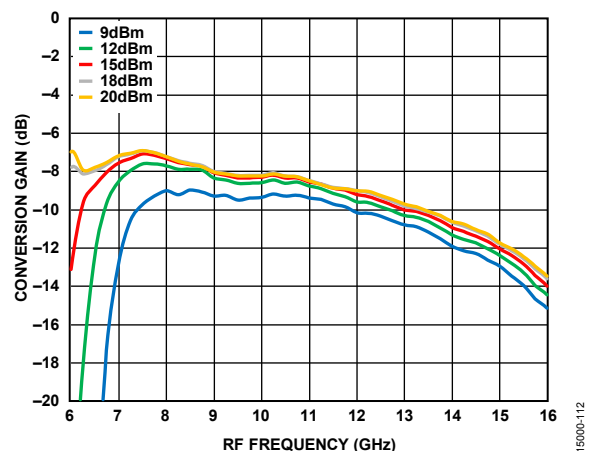

Figure 12. Conversion Gain vs. RF Frequency at Various LO Powers, IF = 2 GHz

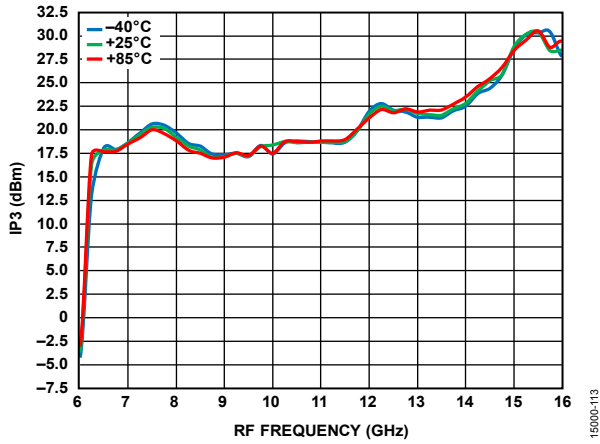

Figure 13. Input IP3 vs. RF Frequency at Various Temperatures, IF = 2 GHz

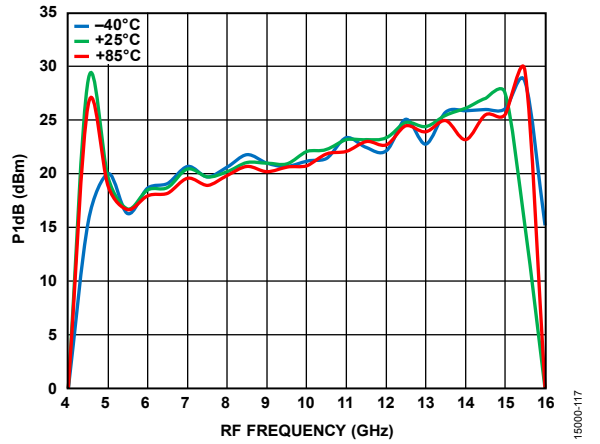

Figure 16. Input P1dB vs. RF Frequency at Various Temperatures, IF = 100 MHz

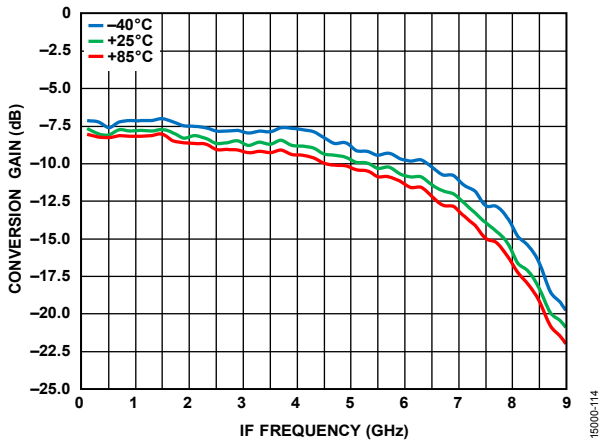

Figure 14. Conversion Gain vs. IF Frequency at Various Temperatures

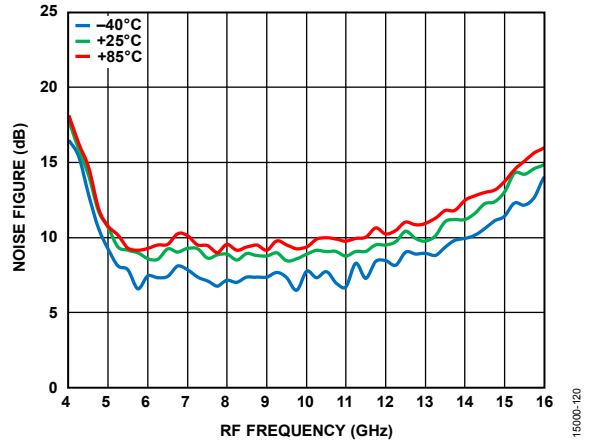

Figure 17. SSB Noise Figure vs. RF Frequency at Various Temperatures, IF = 100 MHz

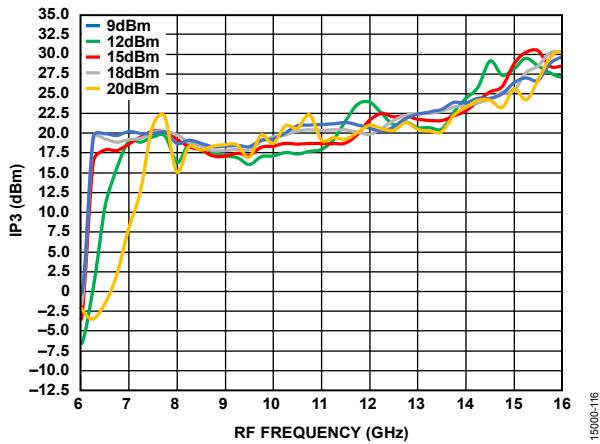

Figure 15. Input IP3 vs. RF Frequency at Various LO Powers, IF = 2 GHz

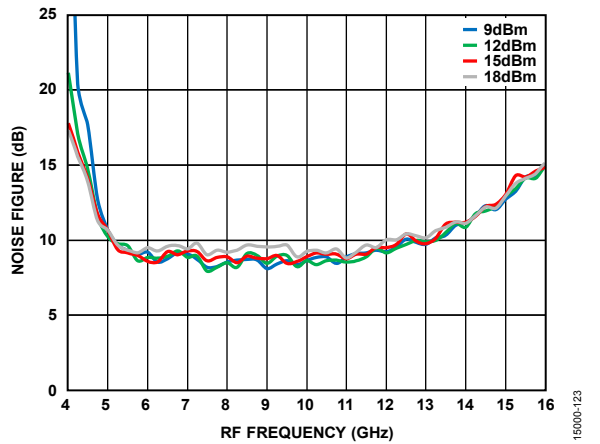

Figure 18. SSB Noise Figure vs. RF Frequency at Various LO Powers, IF = 100 MHz

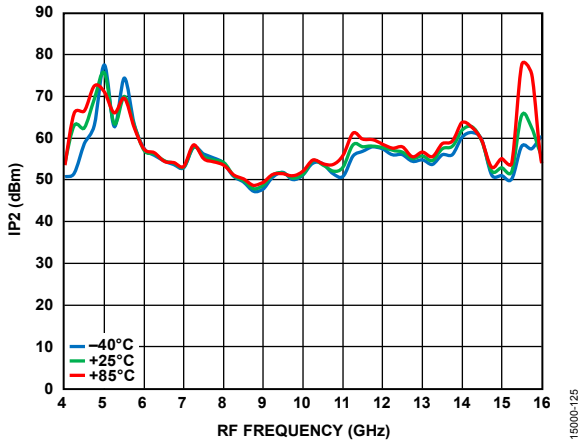

Figure 19. Input IP2 vs. RF Frequency at Various Temperatures, IF = 100 MHz

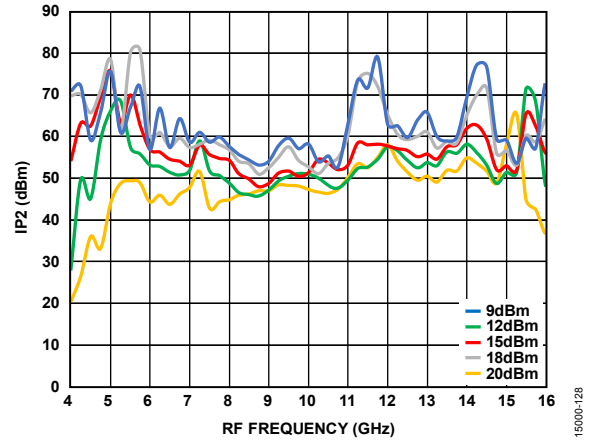

Figure 21. Input IP2 vs. RF Frequency at Various LO Powers, IF = 100 MHz

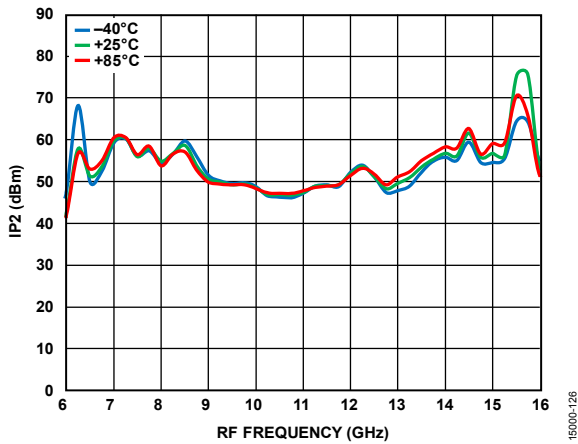

Figure 20. Input IP2 vs. RF Frequency at Various Temperatures, IF = 2000 MHz

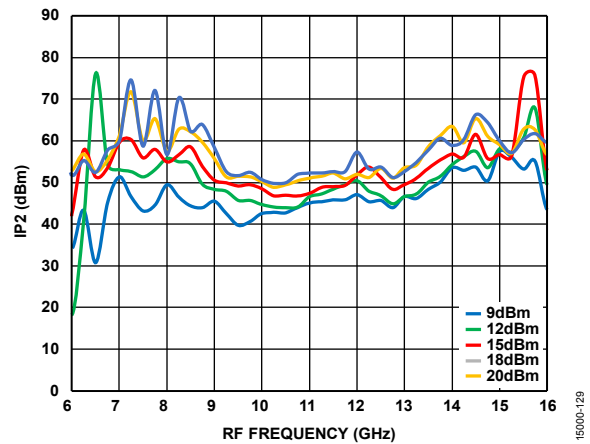

Figure 22. Input IP2 vs. RF Frequency, at Various LO Powers, IF = 2000 MHz

UPCONVERTER PERFORMANCE

Data taken as upconverter, upper sideband, $T_A = 25^\circ\text{C}$, LO drive level = 15 dBm unless otherwise specified.

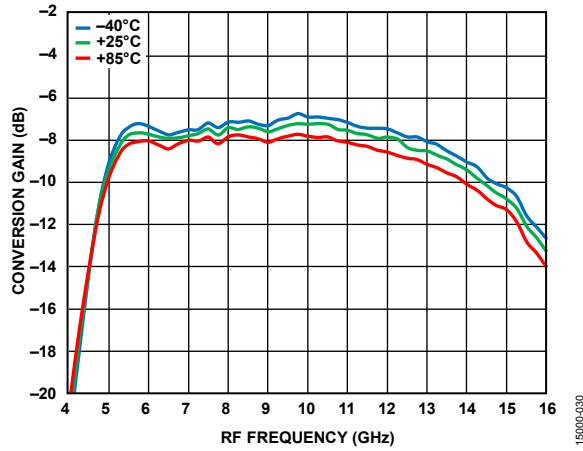

Figure 23. Conversion Gain vs. RF Frequency for Various Temperatures, $IF = 100\text{ MHz}$

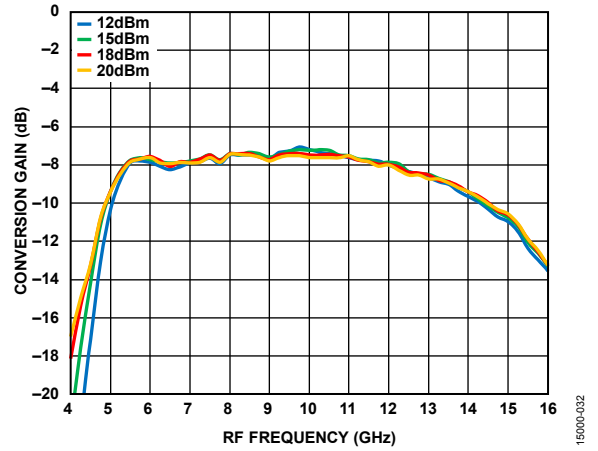

Figure 25. Conversion Gain vs. RF Frequency for Various LO Powers, $IF = 100\text{ MHz}$

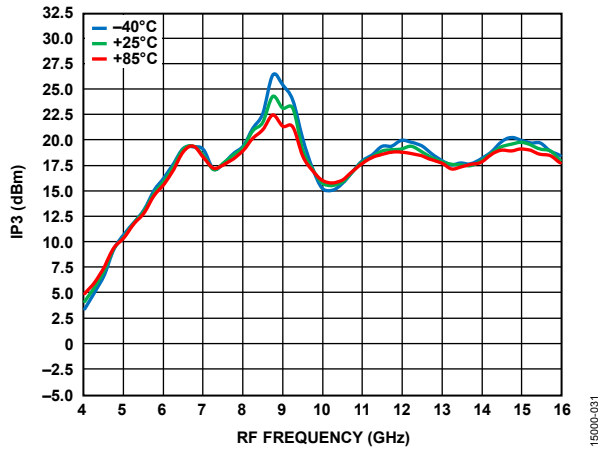

Figure 24. Input IP3 vs. RF Frequency for Various Temperatures, $IF = 100\text{ MHz}$

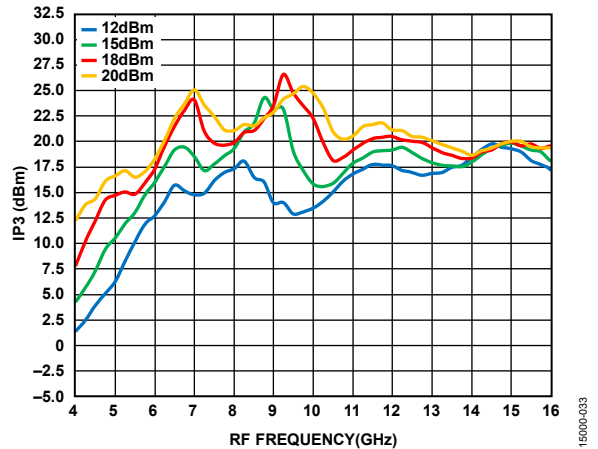

Figure 26. Input IP3 vs. RF Frequency for Various LO Powers, $IF = 100\text{ MHz}$

RETURN LOSS AND ISOLATION PERFORMANCE

Data taken at $T_A = 25^\circ\text{C}$, LO drive level = 15 dBm unless otherwise specified.

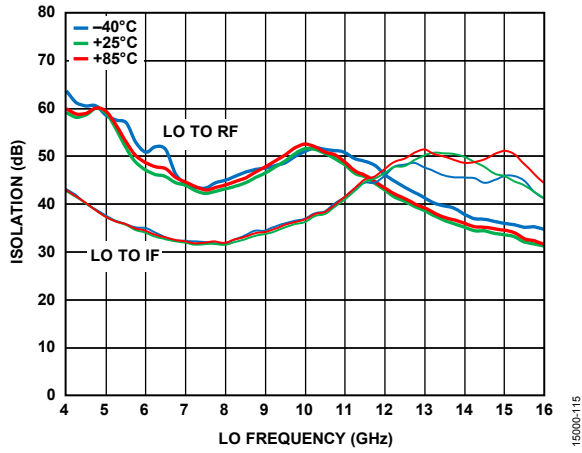

Figure 27. LO to RF and LO to IF Isolation vs. LO Frequency at Various Temperatures, IF = 100 MHz

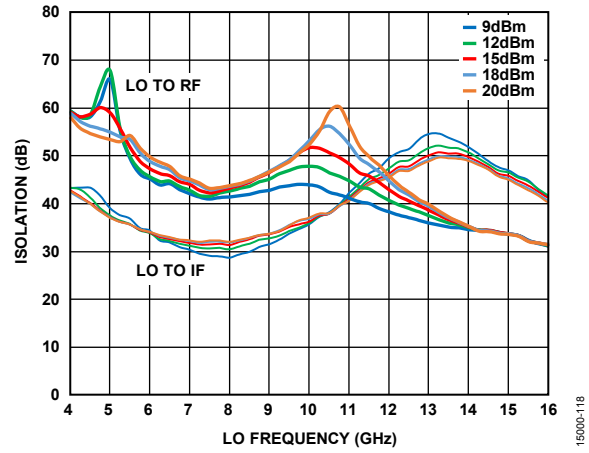

Figure 29. LO to RF and LO to IF Isolation vs. LO Frequency at Various LO Powers, IF = 100 MHz

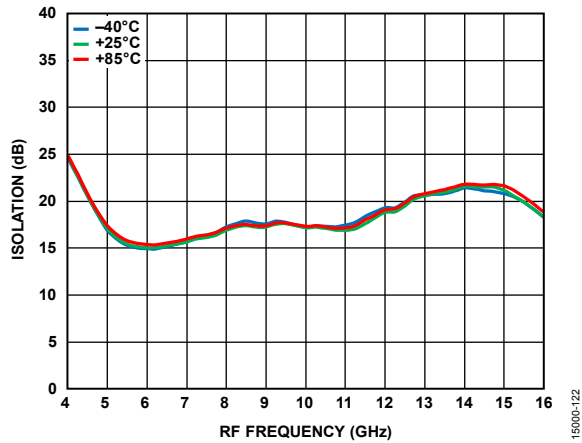

Figure 28. RF to IF Isolation vs. RF Frequency at Various Temperatures, IF = 100 MHz

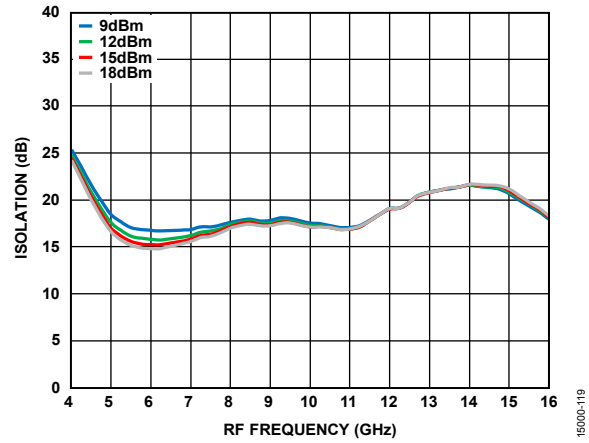

Figure 30. RF to IF Isolation vs. RF Frequency at Various LO Powers, IF = 100 MHz

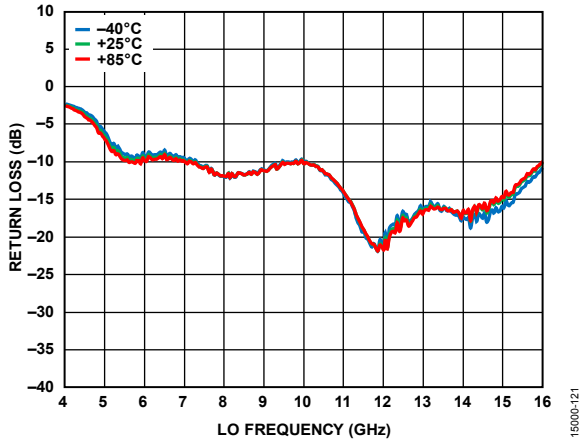

Figure 31. LO Return Loss vs. LO Frequency at Various Temperatures

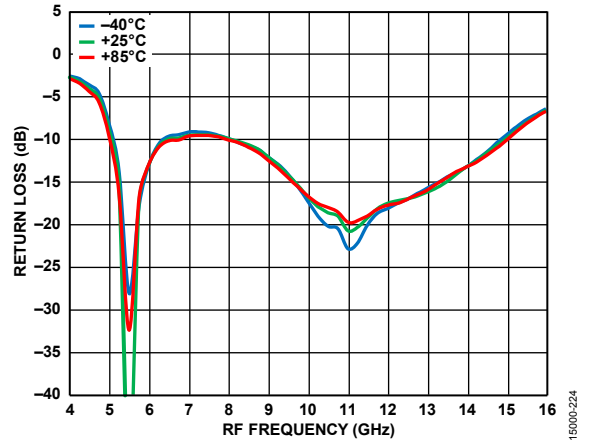

Figure 33. RF Return Loss vs. RF Frequency at Various Temperatures, IF = 100 MHz, LO Power = 15 dBm

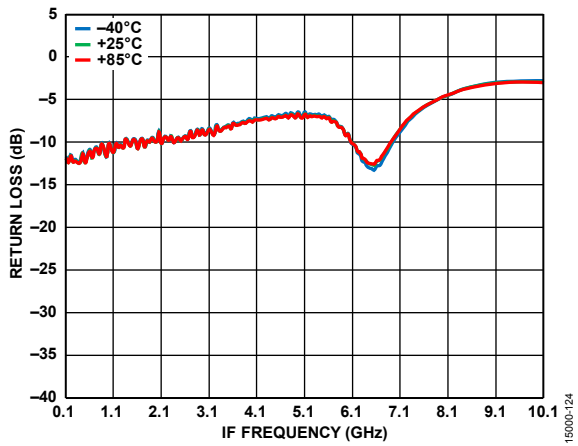

Figure 32. IF Return Loss vs. IF Frequency at Various Temperatures, LO Power = 15 dBm, LO Frequency = 11 GHz

SPURIOUS PERFORMANCE

Mixer spurious products are measured in dBc from the IF output power level. Spur values are $(M \times RF) - (N \times LO)$.

Lower sideband selected, IF = 100 MHz, RF frequency = 8.1 GHz, RF input power = -10 dBm, LO frequency = 8.0 GHz, LO drive = 15 dBm.

		nLO				
		0	1	2	3	4
mRF	0	N/A ¹	-1	24.7	24.4	35.9
	1	10.3	0	22.7	34.9	54.3
	2	83.6	59	64	58.9	81.9
	3	79	84.3	77.8	69.6	75.7
	4	76.3	78.4	84.6	85.7	91.3

¹ N/A means not applicable.

THEORY OF OPERATION

The [HMC558A](#) is a general-purpose double balanced mixer in a leadless RoHS compliant SMT package that can be used as an upconverter or downconverter between 5.5 GHz and 14 GHz. This mixer is fabricated in a GaAs MESFET process, and requires no external components or matching circuitry. The [HMC558A](#) provides excellent LO to RF and LO to IF isolation due to optimized balun structures and operates with LO drive levels as low as 9 dBm. The RoHS compliant [HMC558A](#) eliminates the need for wire bonding, and is compatible with high volume surface mount manufacturing techniques.

APPLICATIONS INFORMATION

TYPICAL APPLICATION CIRCUIT

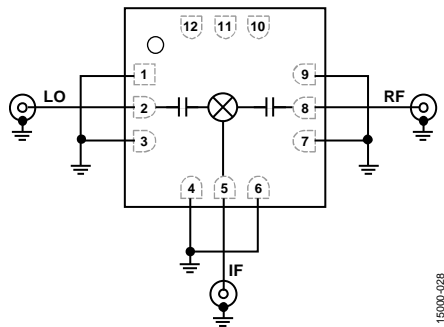

Figure 34. Typical Application Circuit

15000-028

EVALUATION BOARD INFORMATION

The circuit board used in an application must use RF circuit design techniques. Signal lines must have 50 Ω impedance, and the package ground leads and exposed pad must be connected directly to the ground plane, similarly to that shown in Figure 35. Use a sufficient number of via holes to connect the top and bottom ground planes. The evaluation circuit board shown in Figure 35 is available from Analog Devices, Inc., upon request.

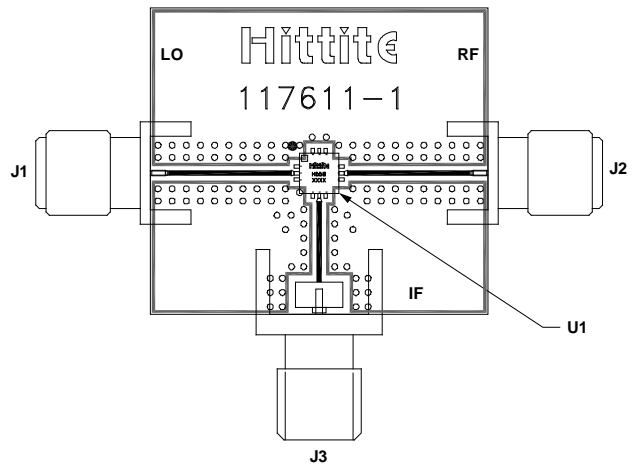

Figure 35. HMC558A Evaluation Board Top Layer

Table 5. Bill of Materials for the EV1HMC558ALC3B Evaluation Board

Level	Item	Part Number	Quantity	Reference Designator	Description
1	1	117611-1	1		PCB, evaluation board
1	2	104935	2	J1 to J2	2.92 mm connector, SRI
1	3	105192	1	J3	SMA connector, Johnson
1	4	HMC558ALC3B	1	U1	Device under test (DUT)

OUTLINE DIMENSIONS

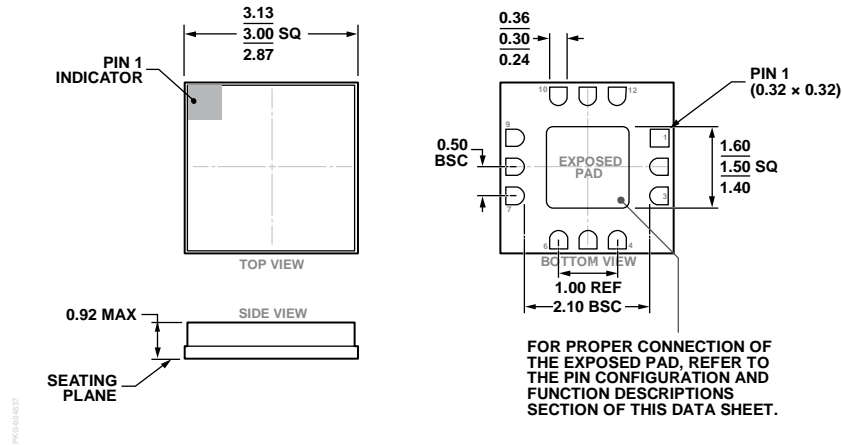

Figure 36. 12-Terminal Ceramic Leadless Chip Carrier [LCC] (E-12-1)
Dimensions shown in millimeters

ORDERING GUIDE

Model ¹	Temperature Range	Description	Package Option	Package Body Material	Lead Finish	MSL Rating	Branding
HMC558ALC3B	-40°C to +85°C	12-Terminal Ceramic Leadless Chip Carrier [LCC]	E-12-1	Alumina Ceramic	Gold over Nickel	MSL3	H558A XXXX
HMC558ALC3BTR	-40°C to +85°C	12-Terminal Ceramic Leadless Chip Carrier [LCC]	E-12-1	Alumina Ceramic	Gold over Nickel	MSL3	H558A XXXX
HMC558ALC3BTR-R5	-40°C to +85°C	12-Terminal Ceramic Leadless Chip Carrier [LCC]	E-12-1	Alumina Ceramic	Gold over Nickel	MSL3	H558A XXXX
EV1HMC558ALC3B		Evaluation PCB Assembly					

¹ Z = RoHS Compliant Part.