

# Specification for Approval

( Tentative 1.0 )

Part No. : LRH1032

comments

LUXPIA Co., Ltd.

Designed by	Checked by	Approved by
/	/	/

---

Approved by	Approved by	Approved by
/	/	/

Date : \_\_\_\_\_ . \_\_\_\_\_ . \_\_\_\_\_ .

Date : \_\_\_\_\_ . \_\_\_\_\_ . \_\_\_\_\_ .

- CONTENTS -

1. Features
2. Package Outline Dimensions and Materials
3. Absolute Maximum Ratings
4. Electro-Optical Characteristics
5. Materials
6. Taping
7. Packing
8. Reliability
9. Warranty
10. Others
11. Characteristic Diagrams

## 1. Features

- Package : SMD Top View Type (2chips in 1)
- Dimension : 3.5 × 2.8 × 1.9 mm (L×W×H)
- Small size surface mount type
- Viewing angle : extremely wide(120°)
- Soldering methods : IR reflow soldering

## 2. Package Outline Dimensions and Recommended Solder Patterns

(unit : mm)

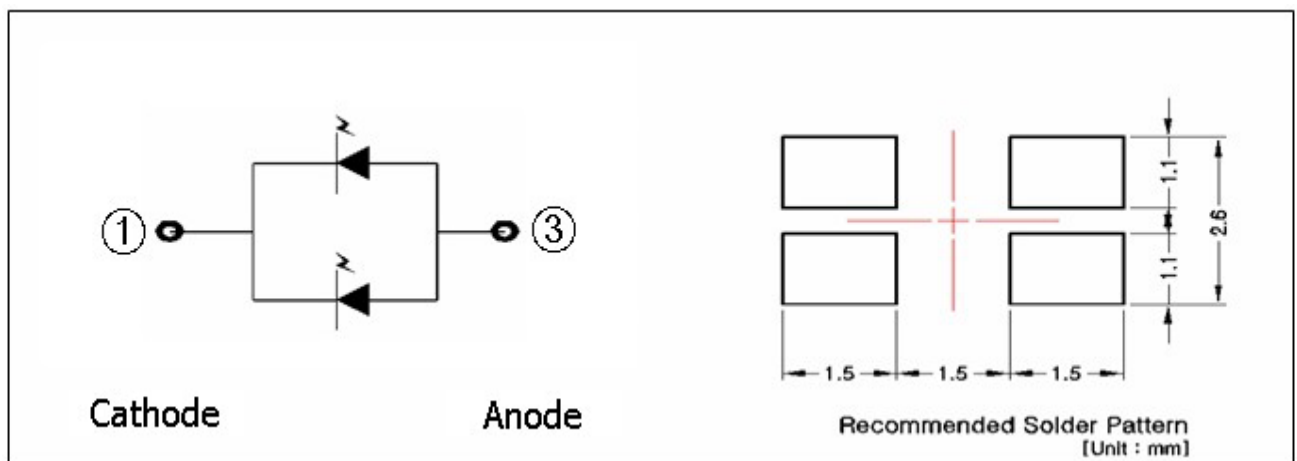
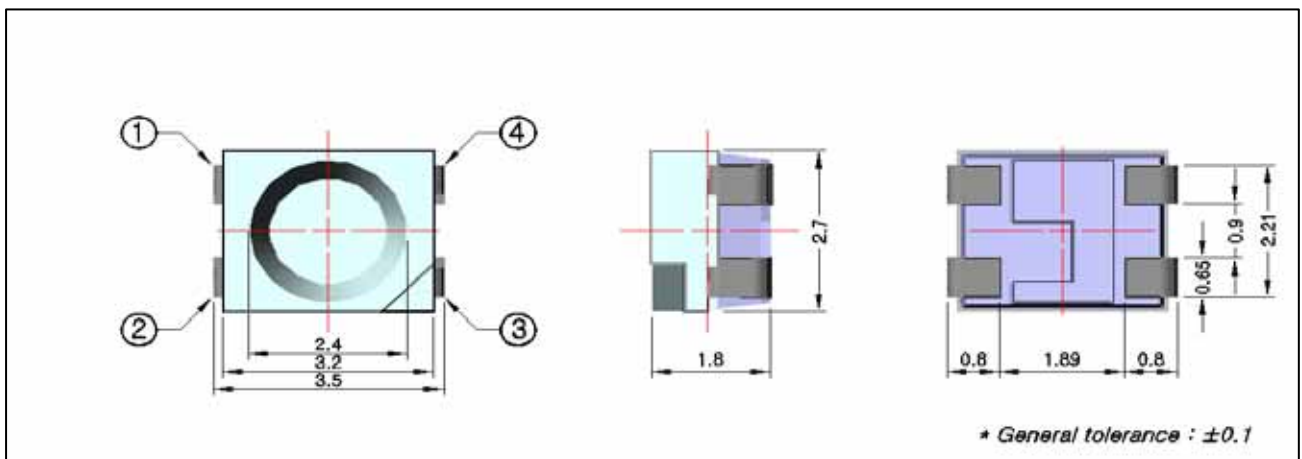

### 3. Absolute Maximum Ratings

( $T_a=25$  )

item	symbol	value	unit
forward current	$I_F$	60	mA
pulse forward current <sup>1)</sup>	$I_{FP}$	100	mA
reverse current	$V_R$	5	V
power dissipation	$P_D$	80	mW
operating temperature	$T_{opr}$	-30 to +85	
storage temperature	$T_{stg}$	-40 to +100	

<sup>1)</sup>  $I_{FP}$  conditions : pulse width  $\leq 10\text{msec}$  & duty ratio  $\leq 1/10$

### 4. Electro-Optical Characteristics

( $T_a=25$  )

item	rank	symbol	condition	min	typ	max	unit
forward voltage <sup>2)</sup>	1	$V_F$	$I_F= 40\text{mA}$	1.8	-	2.0	V
	2			2.0	-	2.2	
	3			2.2	-	2.4	
	4			2.4	-	2.6	
Dominant Wavelength <sup>3)</sup>	-	$\lambda_D$	$I_F= 40\text{mA}$	620	-	630	nm
Luminous intensity <sup>4)</sup>	K	IV	$I_F= 40\text{mA}$	500	-	800	mcd
	L			800	-	1100	
	M			1100	-	1400	
	N			1400	-	1700	
	O			1700	-	2000	
reverse current	-	$I_R$	$V_R=5\text{V}$	-	-	50	$\mu\text{A}$

<sup>2)</sup> Forward voltages are tested at a current pulse duration of 10 ms and an accuracy within  $\pm 0.1\text{V}$ .

<sup>3)</sup> Dominant wavelength are tested at a current pulse duration of 10 ms and an accuracy within  $\pm 1\text{nm}$ .

<sup>4)</sup> The allowance of luminous intensity measurement is within  $\pm 10\%$ .

\* To avoid optical difference, please do not mix differently ranked product.

\* All measurements were made under the standardized environment of LUXPIA.

## 5. Materials

item	material
LED chip	AlGaInP
wire	gold
lead frame	copper alloy/Ni/Ag plating
encapsulation	Silicone resin
heat-resistant polymer	PPA

## 6. Taping

### 6.1. tape (material : PS conductive, $10^4 \sim 10^5 \Omega$ )

(unit : mm)

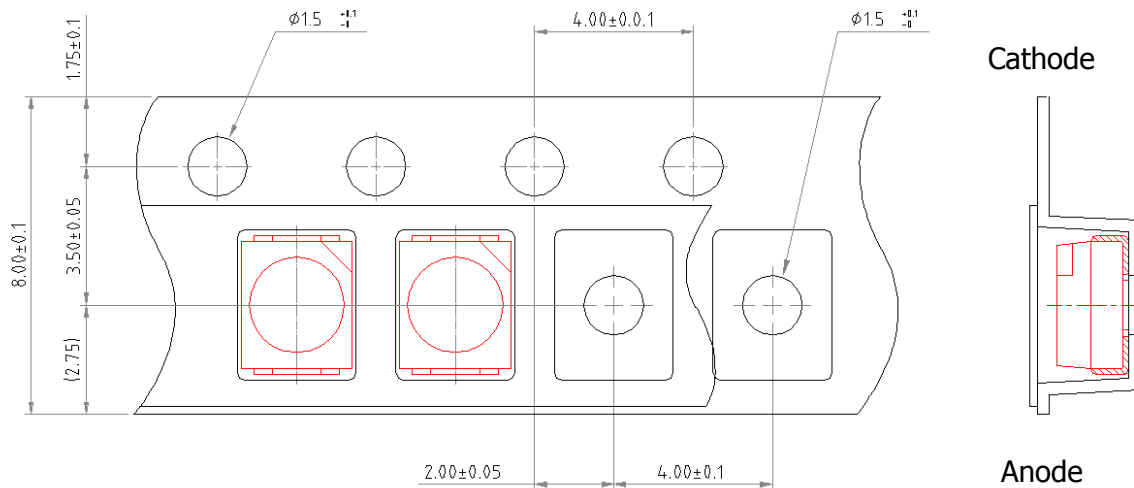

6.2. wheel (color : black)

(unit : mm)

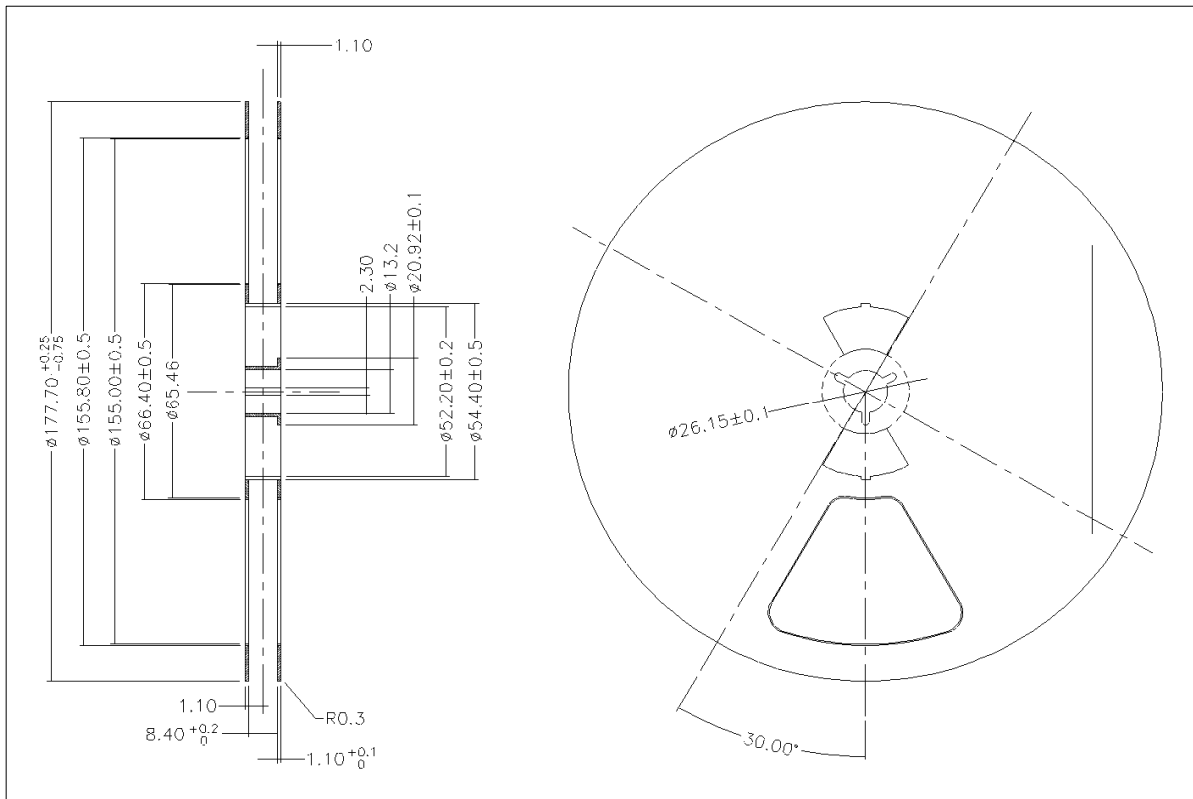

- quantity per reel    LRH1032 : 2,000pcs

6.3. label

part no.

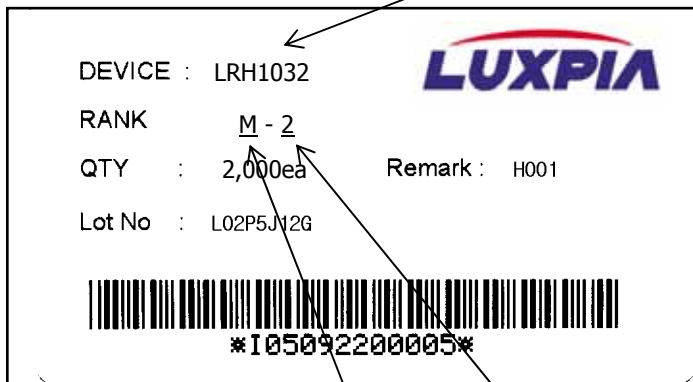

size (L X W) : 85mm × 50mm

I<sub>v</sub> rank

V<sub>F</sub> rank

## 7. Packing

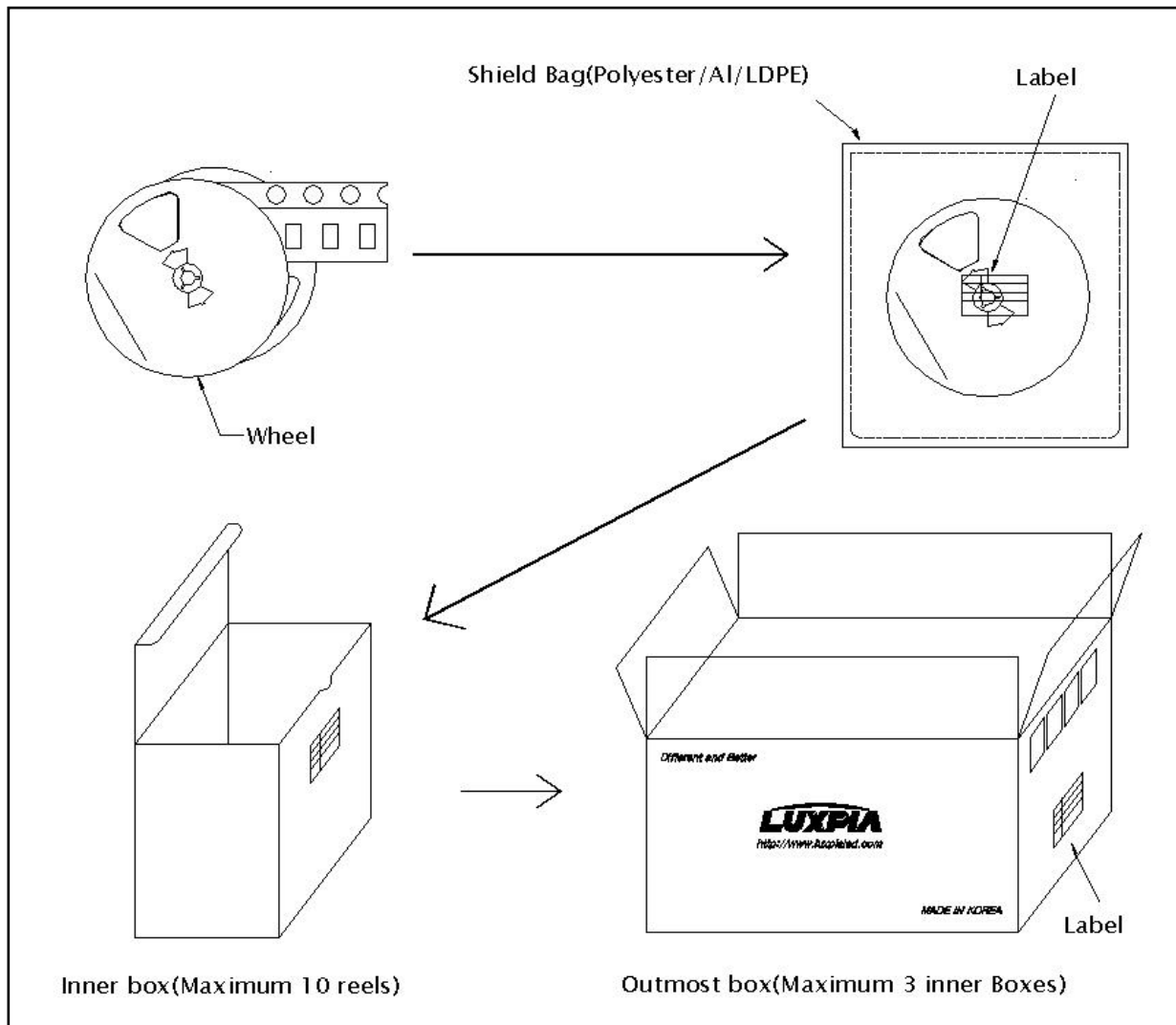

- The LEDs are packed in cardboard boxes after taping. The label shows part number, lot number, rank, and quantity.
- In order to protect the LEDs from mechanical shock, they are packed with cardboard boxes for transportation.
- The LEDs may be damaged if the boxes are dropped or receive a strong impact against them, so cautions must be taken to prevent any possible damage.
- The boxes are not water-resistant and, therefore, must be kept away from water and moisture.
- When the LEDs are transported, it is recommended that the same packing method as Luxpia's is used.
- If noticeable damage on a box appears upon arrival at the user's warehouse, the user should submit a claim to Luxpia within one week after arrival of the products.

## 8. Reliability

### 8.1. test items and results

NO	Test Item	Test Conditions	Note	Number of Damaged
1	resistance to soldering heat (reflow)	$T_{\text{slid}}=260^{\circ}\text{C}$ , 10sec (pre treatment $60^{\circ}\text{C}$ , 90%, 24hrs)	2 times	0/45
2	solderability (reflow)	$T_{\text{slid}}=215\pm 5^{\circ}\text{C}$ , 3sec	1 time over 95%	0/45
3	temperature cycle	$-40^{\circ}\text{C}$ through $+25^{\circ}\text{C}$ to $+100$ (30min/5min/30min)	100 cycles	0/45
4	high temperature storage	$T_a=100$	1000 hrs	0/45
5	high humidity and temperature storage	$T_a=60$ , RH=90%	1000 hrs	0/45
6	low temperature storage	$T_a=-40$	1000 hrs	0/45
7	Steady State Operating Life Condition	$T_a=25$ , $I_F=60\text{mA}$	500 hrs	0/45
8	Steady State Operating Life of High Temperature	$T_a=85$ , $I_F=15\text{mA}$	1000 hrs	0/45
9	Steady State Operating Life of High Humidity Heat	$T_a=60$ , RH=90%, $I_F=40\text{mA}$	500 hrs	0/45
10	Steady State Operating Life of Low Temperature	$T_a=-30$ , $I_F=40\text{mA}$	1000 hrs	0/45

\* LED with Luxpia standard circuit board

### 8.2. criteria for judging the damage

item	symbol	test condition	criteria for judgement	
			min	max
forward voltage	$V_F$	$I_F = 40\text{mA}$	-	U.S.L. <sup>5)</sup> $\times 1.1$
luminous intensity	$I_V$	$I_F = 40\text{mA}$	L.S.L. <sup>6)</sup> $\times 0.7$	-

<sup>5)</sup> U.S.L. : upper standard level

<sup>6)</sup> L.S.L. : lower standard level



## 9. Cautions

The LEDs are device which are materialized by combining Blue LEDs and special phosphors. Consequently, the color of White LEDs is subject to change a little by an operating current.

Care should be taken after due consideration when using LEDs.

### (1) Moisture-Proof Package

- When moisture is absorbed into the SMT package it may vaporize and expand products during soldering. There is a possibility that this may cause exfoliation of the contacts and damage to the optical characteristics of the LEDs. For this reason, the moisture-proof package is used to keep moisture to a minimum in the package.
- A package of a moisture-absorbent material (silica gel) is inserted into the shielding bag. The silica gel changes its color from yellow to green as it absorbs moisture.

### (2) Storage

#### • Storage Conditions

- After opening the package :

The LEDs should be kept at 5 ~40 °C or less and 30%RH or less. The LEDs should be used within a year. When storing the LEDs, moisture-proof packaging with moisture-absorbent material (silica gel) is recommended. If unused LEDs remain, they should be stored in moisture-proof packages, such as sealed containers with packages of moisture-absorbent material (silica gel). It is also recommended to return the LEDs to the original moisture-proof bag and to reseal the moisture-proof bag again.

- If the moisture-absorbent material (silica gel) has faded away or the LEDs have exceeded the recommended storage time, baking treatment should be performed using the following conditions.

- Baking treatment : LED bulk: more than 12 hours at 125±5

LED Reel: more than 24 hours at 60±5

- After assembly and during use, silver plating can be affected by the corrosive gases emitted by components and materials in close proximity of the LEDs within an end product, and the gases entering into the product from the external atmosphere. The above should be taken into consideration when designing.
- Please avoid rapid transitions in ambient temperature, especially in high humidity environments where condensation can occur.

### (3) Heat Generation

- Thermal design of the end product is of paramount importance. Please consider the heat generation of the LED when the system is designed. The coefficient of temperature increase per input electric power is affected by the thermal resistance of the circuit board and density of LED placement on the board, as well as other components. It is necessary to avoid intense heat generation and operate within the maximum ratings given in the specification.

- The operating current should be decided after considering the ambient maximum temperature of LEDs.

### (4) Recommended circuit

- In designing a circuit, the current though each LED must not exceed its absolute maximum rating. It is recommended to use Circuit B which regulates the current flowing through each LED. In the meanwhile, when driving LEDs with a constant voltage in Circuit A, the current through the LEDs may vary due to the variation

in forward (VF) of the LEDs. In worst case, some LED may be subjected to stresses in excess of the absolute maximum rating.



- This product should be operated in forward bias. Driving circuit must be designed so that the product is not subjected to either forward or reverse voltage while it is off. In particular, if a reverse voltage is continuously applied to the product, such operation can cause migration resulting in LED damage.
- Please determine the operating current with consideration of the ambient temperature local to the LED and refer to the plot of Ambient temperature vs. Allowable Forward Current on CHARACTERISTICS in this specifications. Please also take measures to remove heat from the area near the LED to improve the operational characteristics of the LED.

#### (5) Handling Precautions

- Bare Hand

When handling the product, touching encapsulant with bare hands will contaminate its surface that could affect optical characteristics. In the worst cases, excessive force the encapsulant by hands might result in catastrophic failure of the LEDs due to wire deformation and/or breakage.

- Tweezers

Since silicone used as encapsulating resin in this product is a soft material, the upper surface of the product is soft. Pressuring onto the product might cause catastrophic failure of the LEDs due to damage to encapsulant (such as scratch, chip-out and delamination) and wire (such as deformation and breakage) and LED detachment.

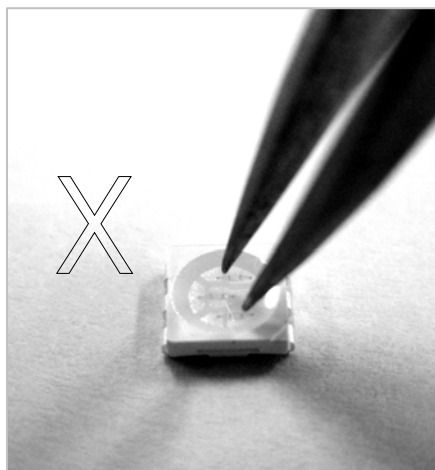

- Pick and Place

Recommended conditions: Outer nozzle 2.4mm

Avoid direct contact to the encapsulant with the picking nozzle.

Failure to comply might result in damage to encapsulant and in the worst cases, catastrophic failure of the LEDs due to wire deformation and/or breakage.

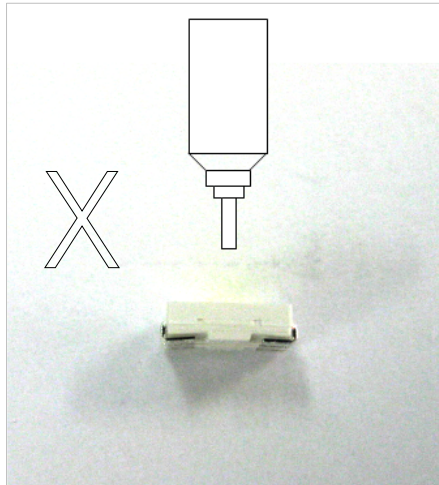

- Drop

Please note that a package damage such as crack might occur when having dropped the product.

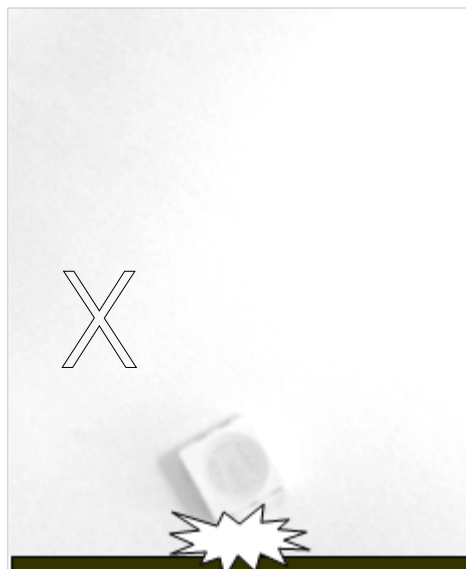

- Printed Circuit Board Assembled (PCB with LEDs soldered)

Do not stack assembled PCBs together. Since silicone is a soft material abrasion between two PCB assembled with encapsulate LED might cause catastrophic failure of the LEDs due to damage to encapsulant (such as scratch, chip-out and delamination) and wire (such as deformation and breakage) and LED detachment.

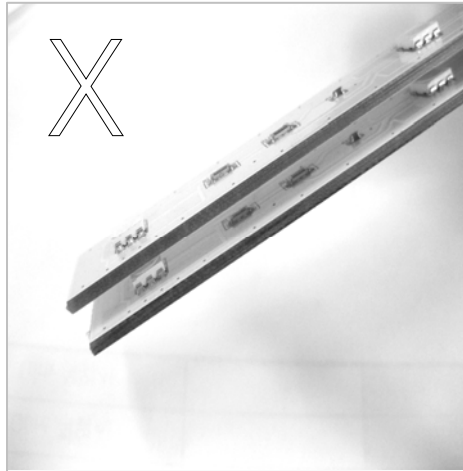

### (6) Soldering Conditions

- The LEDs can be soldered in place using the reflow soldering method. Luxpia does not make any guarantee on the LEDs after they have been assembled using the dip soldering method.
- Recommended soldering conditions

	Reflow Soldering		Hand Soldering	
	Lead Solder	Lead-free Solder	Temperature	Soldering Time
Pre-Heat	120~150	180~200		
Pre-Heat Time	120sec Max.	120sec Max.		
Peak Temperature	240 Max.	260 Max.		
Soldering Time	10sec Max.	10sec Max.		
Condition	refer to profile	refer to profile		

\* Although the recommended soldering conditions are specified in the above table, reflow soldering at the lowest possible temperature is desirable for the LEDs.

\* A rapid-rate process is not recommended for cooling the LEDs down from the peak temperature.

[Temperature-Profile (surface of circuit board)]

Use the conditions shown to the following figures.

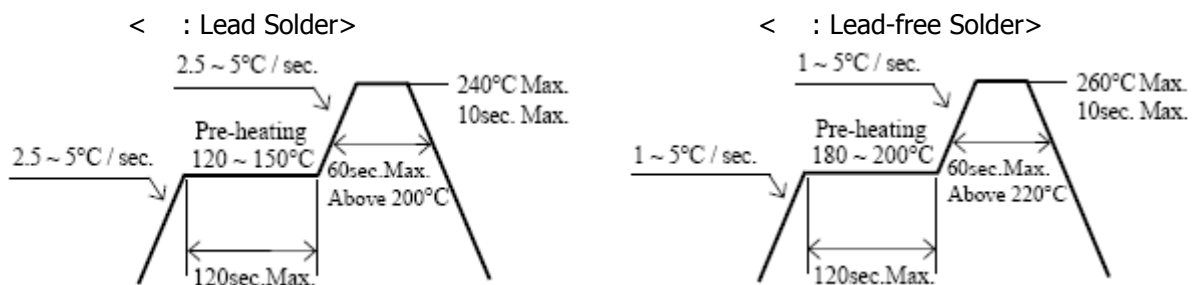

- Occasionally there is a brightness decrease caused by the influence of heat or ambient atmosphere during air reflow. It is recommended that the User use the nitrogen reflow method.
- Repairing should not be done after the LEDs have been soldered. When repairing is unavoidable, a double-head soldering iron should be used. It should be confirmed beforehand whether the characteristics of the LEDs will or will not be damaged by repairing.

- Reflow soldering should not be done more than two times.
- When soldering, do not put stress on the LEDs during heating.
- After soldering, do not warp the circuit board.

#### (7) Cleaning

- It is recommended that isopropyl alcohol be used as a solvent for cleaning the LEDs. When using other solvents, it should be confirmed beforehand whether the solvents will dissolve the package and the resin or not. Freon solvents should not be used to clean the LEDs because of worldwide regulations. Do not clean the LEDs by the ultrasonic. When it is absolutely necessary, the influence of ultrasonic cleaning on the LEDs depends on factors such as ultrasonic power and the assembled condition. Before cleaning, a pre-test should be done to confirm whether any damage to the LEDs will occur.

#### (8) Static Electricity

- Static electricity or surge voltage damages the LEDs. It is recommended that a wrist band or an anti-electrostatic glove be used when handling the LEDs.
  - All devices, equipment and machinery must be properly grounded. It is recommended that measurements be taken against surge voltage to the equipment that mounts the LEDs.
  - When inspecting the final products in which LEDs were assembled, it is recommended to check whether the assembled LEDs are damaged by static electricity or not. It is easy to find static-damaged LEDs by a light-on test or a  $V_F$  test at a lower current (below 1mA is recommended).
  - Damaged LEDs will show some unusual characteristics such as the leak current remarkably increases, the forward voltage becomes lower, or the LEDs do not light at the low current.
- criteria :  $V_F > 1.0V$  at  $I_F=0.5mA$

#### (9) Others

- This LED complies with RoHS Directive.
- The LED light output is strong enough to injure human eyes. Precautions must be taken to prevent looking directly at the LEDs with unaided eyes for more than a few seconds.
- Flashing lights have been known to cause discomfort in people; you can prevent this by taking precautions during use. Also, people should be cautious when using equipment that has had LEDs incorporated into it.
- The customer not reverse engineer by disassembling or analysis of the LEDs without having prior written consent from Luxpia. When defective LEDs are found, the User shall inform Luxpia directly before disassembling or analysis.
- The warranties of quality set forth herein are exclusive. All previous negotiations and agreements not specifically incorporated herein are superseded and rendered null and void.
- Both parties shall sincerely try to find a solution when any disagreement occurs regarding these specifications.
- These specifications can be revised upon mutual agreement.
- Luxpia understands that the User accepts the content of these specifications, if the User does not return these specifications with signatures within 3 weeks after receipt.
- The LEDs described in the specification are intended to be used for ordinary electronic equipment (such as office equipment, communications equipment, on the applications in which exceptional quality and reliability are required, particularly when the failure or malfunction of the LEDs may directly jeopardize life or health (such as for airplanes, aerospace, submersible repeaters, nuclear reactor control systems, automobiles, traffic control equipment, life support systems and safety devices)

## 10. Warranty

- (1) Luxpia warrants that its LEDs conform to the foregoing specifications and that Luxpia will convey good title to all LEDs sold.
- (2) LUXPIA disclaims all other warranties including the implied warranties of merchantability and fitness for a particular purpose.
- (3) In the event any LED supplied by Luxpia is found not to conform to the foregoing specifications within ninety days of receipt, Luxpia will repair or replace the LED, at Luxpia's discretion, provided that the User (a) promptly notifies Luxpia in writing of the details of the defect (b) ships the LEDs at the User's expense to Luxpia for examination, and (c) the defect is due to the negligence of Luxpia and not mishandling or misuse by the User.
- (4) Luxpia will not take responsibility for any trouble that is caused by using the LEDs at conditions exceeding our specifications.
- (5) These specifications are applied only when a LED stands alone and it is strongly recommended that the User of the LEDs confirms the properties upon assembly. Luxpia is not responsible for failures caused during and after assembling. It will be excepted from the rule if the failure would be caused undoubtedly by Luxpia.
- (6) A claim report stating details about the defect shall be made when returning defective LEDs. Luxpia will investigate the report immediately and inform the user of the results.
- (7) LUXPIA's liability for defective lamps shall be limited to replacement and in no event shall LUXPIA be liable for consequential damage or lost profits.

## 11. Characteristic Diagrams

\*All characteristics shown are for reference only are not guarantee.

(1) forward voltage vs. forward current

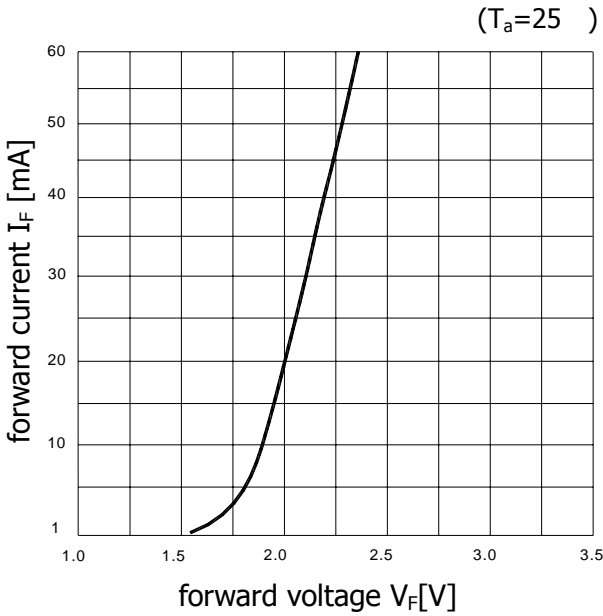

(2) forward current vs. relative luminosity

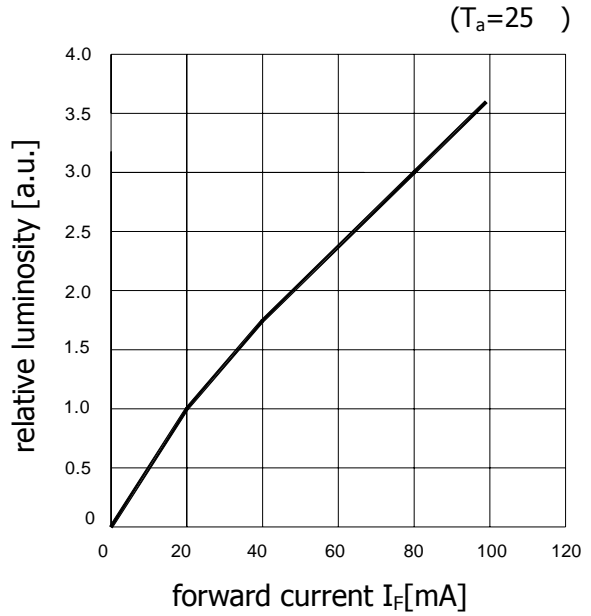

(3) ambient temperature vs. allowable forward current

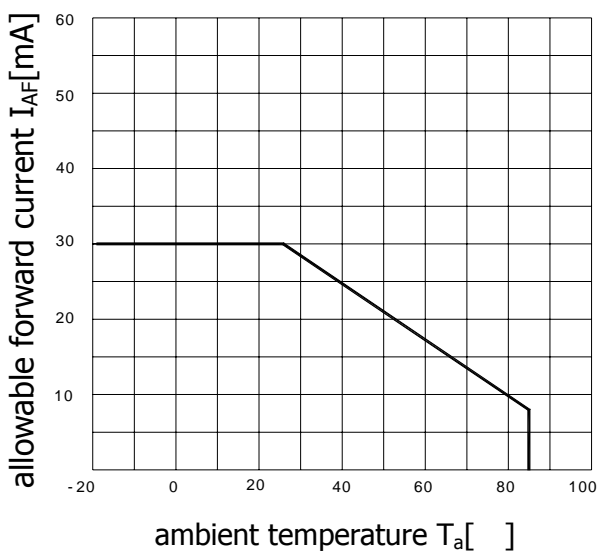

(4) ambient temperature vs. relative luminosity

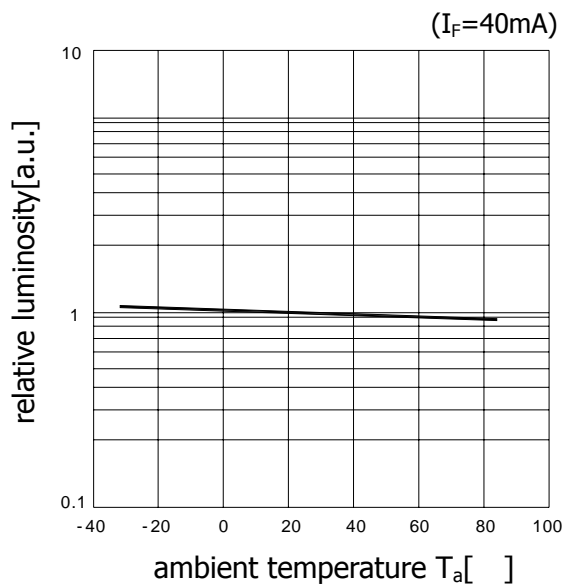

(5) relative spectral emission

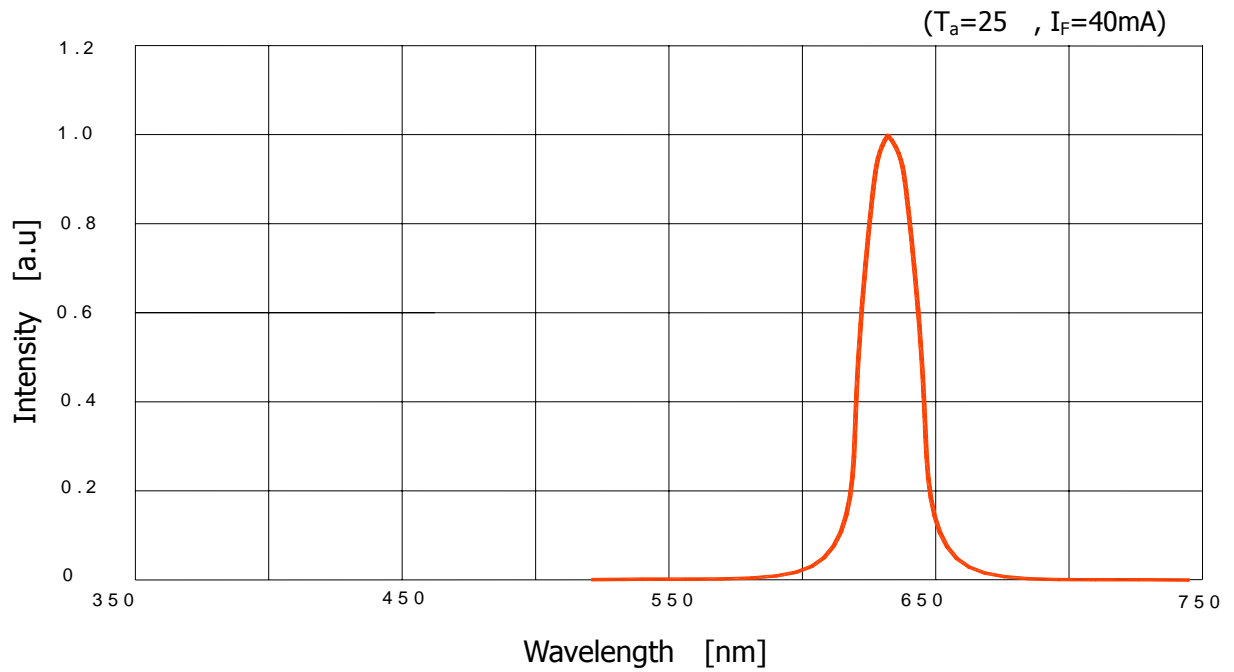

(6) radiation characteristics

