

## 5V, Dual Trip Point Temperature Sensors

### Features

- User Programmable Hysteresis and Temperature Set Point
- Easily Programs with Two External Resistors
- Wide Temperature Detection Range:
  - 0°C to 70°C: (TC620/TC621CCX)
  - -40°C to +125°C: (TC620/TC621CVX)
  - -40°C to +85°C: (TC620/TC621CEX)
- Onboard Temperature Sensing Applications (TC620X)
- External NTC Thermistor for Remote Sensing Applications (TC621X)
- Available in 8-Pin PDIP and SOIC Packages

### Applications

- Power Supply Over Temperature Detection
- Consumer Equipment
- Temperature Regulators
- CPU Thermal Protection

### Device Selection Table

Part Number	Package	Temperature Range
TC620X*COA	8-Pin SOIC	0°C to +70°C
TC620X*CPA	8-Pin PDIP	0°C to +70°C
TC620X*EOA	8-Pin SOIC	-40°C to +85°C
TC620X*EPA	8-Pin PDIP	-40°C to +85°C
TC620C*VOA	8-Pin SOIC	-40°C to +125°C
TC621X*COA	8-Pin SOIC	0°C to +70°C
TC621X*CPA	8-Pin PDIP	0°C to +70°C
TC621X*EOA	8-Pin SOIC	-40°C to +85°C
TC621X*EPA	8-Pin PDIP	-40°C to +85°C
TC621C*VOA	8-Pin SOIC	-40°C to +125°C

**Note:** \*The part code will be C or H (see Functional Block Diagrams).

### Package Type



### General Description

The TC620 and TC621 are programmable logic output temperature detectors designed for use in thermal management applications. The TC620 features an onboard temperature sensor, while the TC621 connects to an external NTC thermistor for remote sensing applications.

Both devices feature dual thermal interrupt outputs (HIGH LIMIT and LOW LIMIT), each of which is programmed with a single external resistor. On the TC620, these outputs are driven active (high) when measured temperature equals the user programmed limits. The CONTROL (hysteresis) output is driven high when temperature equals the high limit setting and returns low when temperature falls below the low limit setting. This output can be used to provide ON/OFF control to a cooling fan or heater. The TC621 provides the same output functions except that the logical states are inverted.

The TC620/TC621 are usable over operating temperature ranges of 0°C to 70°C, -40°C to +125°C.

# TC620/TC621

## Functional Block Diagrams



\*Suffix code "C" denotes cooling option (High true CONTROL output).  
 Suffix code "H" denotes heating option (Low true CONTROL output).

## 1.0 ELECTRICAL CHARACTERISTICS

### Absolute Maximum Ratings\*

Supply Voltage .....	20V
Input Voltage Any Input.. (GND – 0.3V) to (V <sub>DD</sub> +0.3V)	
Package Power Dissipation (T <sub>A</sub> ≤ 70°C)	
PDIP .....	730 mW
SOIC .....	470 mW
Derating Factors:	
Plastic .....	8 mW/°C
Operating Temperature:	
V Version .....	-40°C to +125°C
E Version .....	-40°C to +85°C
C Version .....	0°C to +70°C
Storage Temperature .....	-65°C to +150°C

\*Stresses above those listed under “Absolute Maximum Ratings” may cause permanent damage to the device. These are stress ratings only and functional operation of the device at these or any other conditions above those indicated in the operation sections of the specifications is not implied. Exposure to Absolute Maximum Rating conditions for extended periods may affect device reliability.

## TC620/TC621 ELECTRICAL SPECIFICATIONS

Electrical Characteristics: T <sub>A</sub> = 25°C, unless otherwise specified.						
Symbol	Parameter	Min.	Typ.	Max.	Unit	Test Conditions
V <sub>DD</sub>	Supply Voltage Range	4.5	—	18	V	
I <sub>DD</sub>	Supply Current	—	270	400	μA	5V ≤ V <sub>DD</sub> ≤ 18V
R <sub>OUT</sub>	Output Resistance	—	400	1000	Ω	Output High or Low, 5V ≤ V <sub>DD</sub> ≤ 18V
I <sub>OUT</sub>	Output Current	—	—	1	mA	Temp. Sensed      Source/Sink
I <sub>OUT</sub>	Output Current	—	—	1	mA	Cool/Heat            Source/Sink
T <sub>ERR</sub>	Absolute Accuracy	T - 3	T	T + 3	°C	T = Programmed Temperature

## TEMPERATURE CHARACTERISTICS

Electrical Specifications: Unless otherwise noted, all parameters apply with 4.5V ≤ V <sub>DD</sub> ≤ 18V.						
Parameters	Sym.	Min.	Typ.	Max.	Units	Conditions
<b>Temperature Ranges</b>						
Specified Temperature Range (C)	T <sub>A</sub>	0	—	+70	°C	
Specified Temperature Range (E)	T <sub>A</sub>	-40	—	+85	°C	
Specified Temperature Range (V)	T <sub>A</sub>	-40	—	+125	°C	
Maximum Junction Temperature	T <sub>J</sub>	—	—	+150	°C	
Storage Temperature Range	T <sub>A</sub>	-65	—	+150	°C	
<b>Package Thermal Resistances</b>						
Thermal Resistance, 8L-PDIP	θ <sub>JA</sub>	—	125	—	°C/W	
Thermal Resistance, 8L-SOIC	θ <sub>JA</sub>	—	155	—	°C/W	

# TC620/TC621

## 2.0 PIN DESCRIPTIONS

The descriptions of the pins are listed in [Table 2-1](#).

**TABLE 2-1: TC620 PIN FUNCTION TABLE**

Pin No. (8-Pin PDIP) (8-Pin SOIC)	Symbol	Description
1	NC	No Internal Connection.
2	LOW SET	Low temperature set point. Connect an external 1% resistor from LOW SET to $V_{DD}$ to set trip point.
3	HIGH SET	High temperature set point. Connect an external 1% resistor from HIGH SET to $V_{DD}$ to set trip point.
4	GND	Ground Terminal.
5	CONTROL	Control output.
6	HIGH LIMIT	High temperature push/pull output.
7	LOW LIMIT	Low temperature push/pull output.
8	$V_{DD}$	Power supply input.

**TABLE 2-2: TC621 PIN FUNCTION TABLE**

Pin No. (8-Pin PDIP) (8-Pin SOIC)	Symbol	Description
1	THERMISTOR	Thermistor input.
2	HIGH SET	High temperature set point. Connect an external 1% resistor from HIGH SET to $V_{DD}$ to set trip point.
3	LOW SET	Low temperature set point. Connect an external 1% resistor from LOW SET to $V_{DD}$ to set trip point.
4	GND	Ground Terminal.
5	CONTROL	Control output.
6	$\overline{\text{LOW}} \text{ LIMIT}$	Low temperature push/pull output.
7	$\overline{\text{HIGH}} \text{ LIMIT}$	High temperature push/pull output.
8	$V_{DD}$	Power supply input.

## 3.0 DETAILED DESCRIPTION

The TC620 has a positive temperature coefficient temperature sensor and a dual threshold detector. Temperature set point programming is accomplished with external resistors from the HIGH SET and LOW SET inputs to  $V_{DD}$ . The HIGH LIMIT and LOW LIMIT outputs remain low as long as measured temperature is below set point values. As measured temperature increases, the LOW LIMIT output is driven high when temperature equals the LOW SET set point ( $\pm 3^\circ\text{C}$  max). If temperature continues to climb, the HIGH LIMIT output is driven high when temperature equals the HIGH SET set point (Figure 3-1). The CONTROL (hysteresis) output is latched in its active state at the temperature specified by the HIGH SET resistor. CONTROL is maintained active until temperature falls to the value specified by the LOW SET resistor.

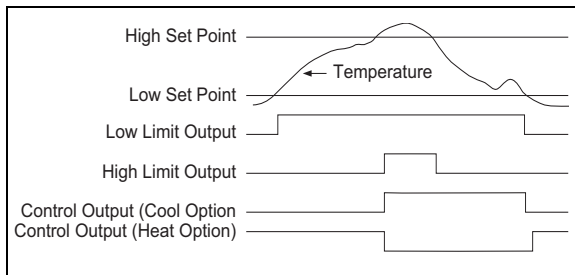

**FIGURE 3-1:** TC620/TC621 Input vs. Output Logic.

### 3.1 Programming the TC620

The resistor values to achieve the desired trip point temperatures on HIGH SET and LOW SET are calculated using Equation 3-1:

#### EQUATION 3-1:

$$R_{\text{TRIP}} = 0.5997 \times T^{2.1312}$$

Where:

$R_{\text{TRIP}}$  = Programming resistor in Ohms  
 $T$  = The desired trip point temperature in degrees Kelvin.

For example, a  $50^\circ\text{C}$  setting on either the HIGH SET or LOW SET input is calculated using Equation 3-2 as follows:

#### EQUATION 3-2:

$$R_{\text{SET}} = 0.5997 \times ((50 + 273.15)^{2.1312}) = 133.6 \text{ k}\Omega$$

Care must be taken to ensure the LOW SET programming resistor is a smaller value than the HIGH SET programming resistor. Failure to do this will result in erroneous operation of the CONTROL output.

Care must also be taken to ensure the LOW SET temperature setting is at least  $5^\circ\text{C}$  lower than the HIGH SET temperature setting.

Figure 3-2 can help the user obtain an estimate of the external resistor values required for the desired LOW SET and HIGH SET trip points.

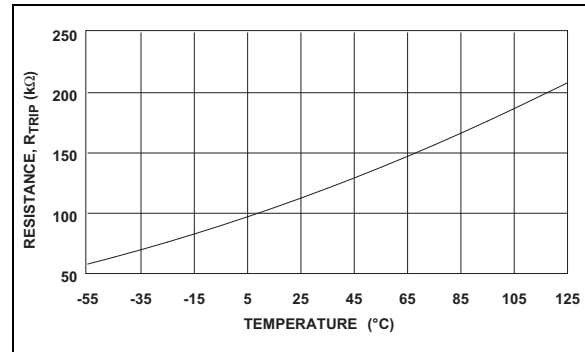

**FIGURE 3-2:** TC620 Sense Resistors vs. Trip Temperature.

### 3.2 Built-in Hysteresis

To prevent output “chattering” when measured temperature is at (or near) the programmed trip point values, the LOW SET and HIGH SET inputs each have built-in hysteresis of  $-2^\circ\text{C}$  below the programmed settings (Figure 3-3).

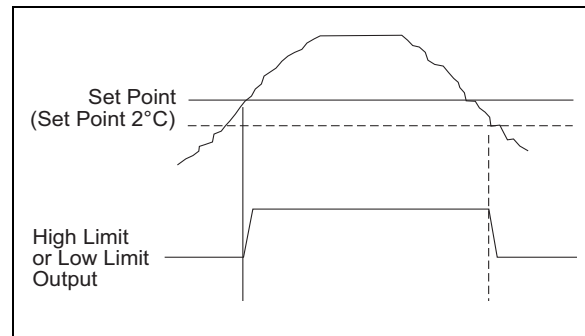

**FIGURE 3-3:** Built-In Hysteresis on Low Limit and High Limit Outputs.

As shown, the outputs remain in their active state (hysteresis) until temperature falls an additional  $2^\circ\text{C}$  below the user’s setting.

# TC620/TC621

## 3.3 Using the TC621

The TC621 operation is similar to that of the TC620, but requires an external NTC thermistor. Use the resistance versus temperature curve of the thermistor to determine the values of the programming resistors. Note that the pin numbers for the HIGH SET and LOW SET programming resistors for the TC621 are reversed versus that of the TC620 (i.e., the resistor value on HIGH SET [Pin 2] should always be lower than the one connected to LOW SET [Pin 3]). Also note that the outputs of the TC621 are LOW TRUE when used with an NTC thermistor.

## 3.4 TC621 Thermistor Selection

The TC621 uses an external thermistor to monitor the controlling temperature. A thermistor with a resistance value of approximately 100 k $\Omega$  at 25°C is recommended.

A temperature set point is selected by picking a resistor whose value is equal to the resistance of the thermistor at the desired temperature. For example, using the data shown in [Figure 3-4](#), a 30 k $\Omega$  resistor between HIGH TEMP (Pin 2) and V<sub>DD</sub> (Pin 8) sets the high temperature trip point at +51°C and a 49 k $\Omega$  resistor on LOW TEMP (Pin 3) sets the low temperature trip point to +41°C.

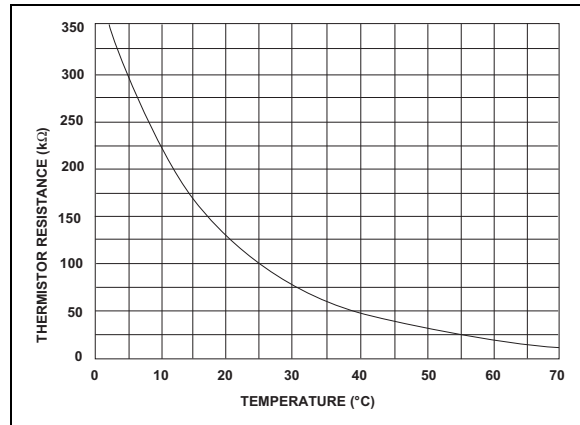

**FIGURE 3-4:** Typical NTC Thermistor.

## 3.5 TC620/TC621 Outputs

Both devices have complimentary output stages. They are rated at a source or sink current of 1 mA maximum.

## 4.0 TYPICAL APPLICATIONS

### 4.1 Dual Speed Temperature Control

In Figure 4-1, the Dual Speed Temperature Control uses a TC620 and a TC4469 quad driver. Two of the drivers of the TC4469 are configured in a simple oscillator. When the temperature is below the LOW TEMP set point, the output of the driver is OFF. When the temperature exceeds the LOW TEMP set point, the TC4469 gates the oscillator signal to the outputs of the driver. This square wave signal modulates the remaining outputs and drives the motor at a low speed. If this speed cannot keep the temperature below the HIGH TEMP set point, then the driver turns on continuously which increases the fan speed to high. The TC620 will monitor the temperature and only allow the fan to operate when needed and at the required speed to maintain the desired temperature. A higher power option can be designed by adding a resistor and a power MOSFET.

### 4.2 Temperature Controlled Fan

In the application in Figure 4-2, a high and a low temperature is selected by two  $R_L$  and  $R_H$ . The TC620 monitors the ambient temperature and turns the FET switch on when the temperature exceeds the HIGH TEMP set point. The fan remains on until the temperature decreases to the LOW TEMP set point. This provides the hysteresis. In this application, the fan turns on only when required.

The TC621 uses an external thermistor to monitor the ambient temperature. This adds one part, but allows more flexibility with the location of the temperature sensor.

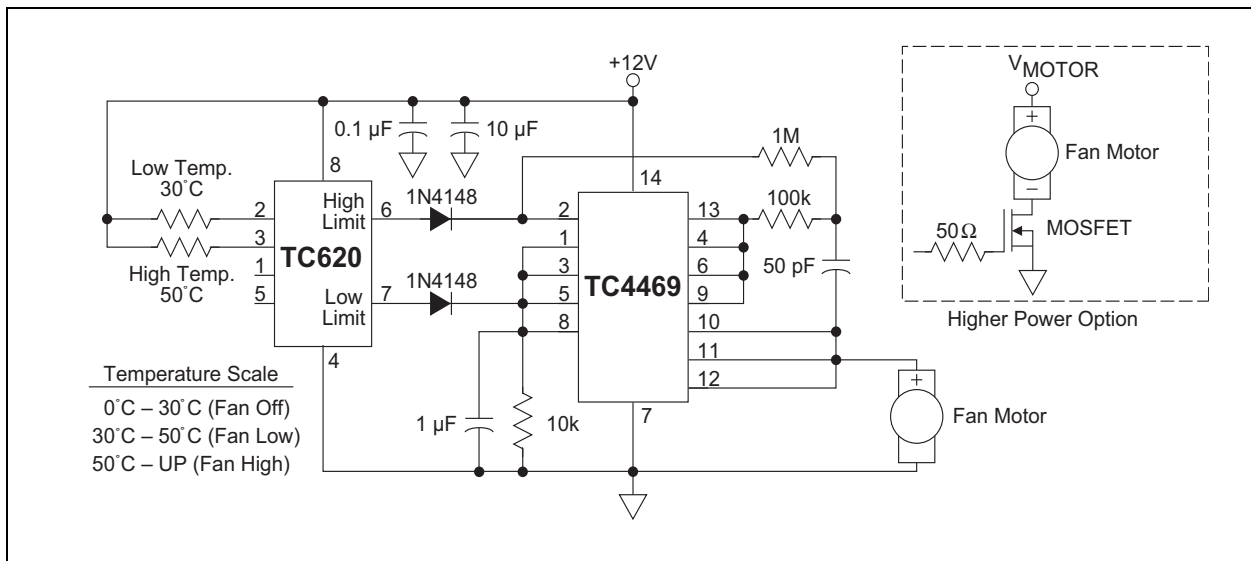

FIGURE 4-1: Dual Speed Temperature Control.

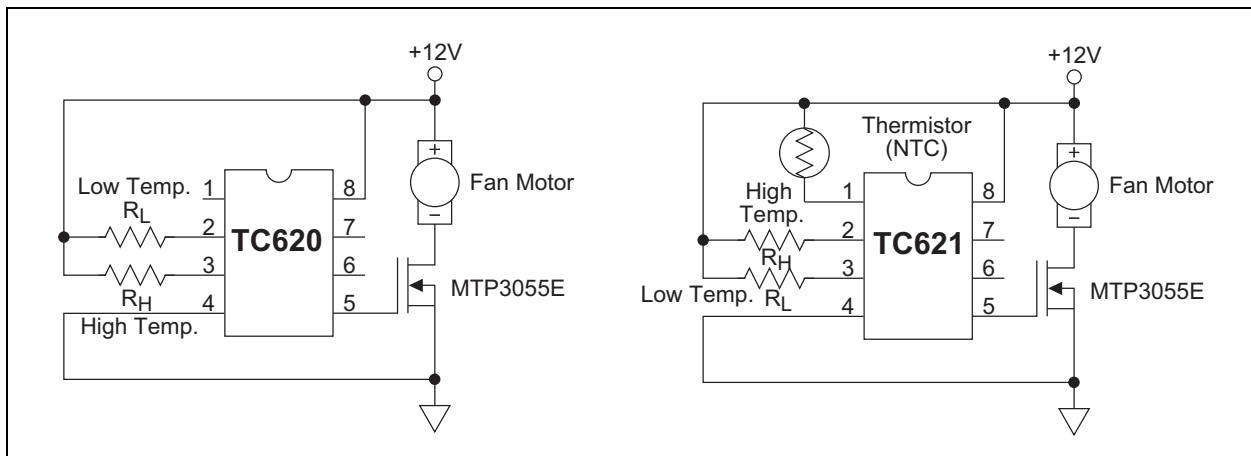

FIGURE 4-2: Temperature Controlled Fan.

# TC620/TC621



**FIGURE 4-3:** Heating and Cooling Application.



## 5.0 PACKAGING INFORMATION

### 5.1 Package Marking Information

8-Lead PDIP (300 mil)

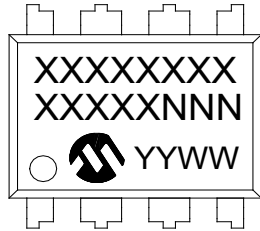

Example

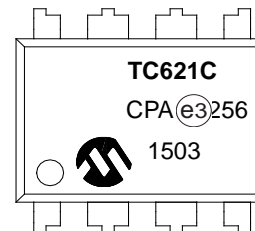
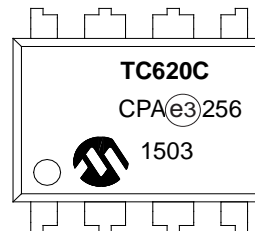

8-Lead SOIC (150 mil)

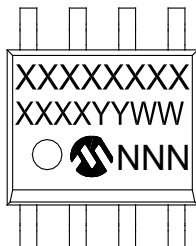

Example

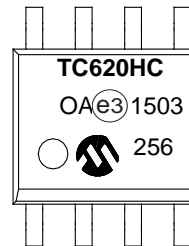

<b>Legend:</b>	XX...X	Customer-specific information
	Y	Year code (last digit of calendar year)
	YY	Year code (last 2 digits of calendar year)
	WW	Week code (week of January 1 is week '01')
	NNN	Alphanumeric traceability code
	(e3)	Pb-free JEDEC® designator for Matte Tin (Sn)
	*	This package is Pb-free. The Pb-free JEDEC designator ((e3)) can be found on the outer packaging for this package.

**Note:** In the event the full Microchip part number cannot be marked on one line, it will be carried over to the next line, thus limiting the number of available characters for customer-specific information.

# TC620/TC621

## 8-Lead Plastic Dual In-Line (PA) – 300 mil Body [PDIP]

**Note:** For the most current package drawings, please see the Microchip Packaging Specification located at <http://www.microchip.com/packaging>

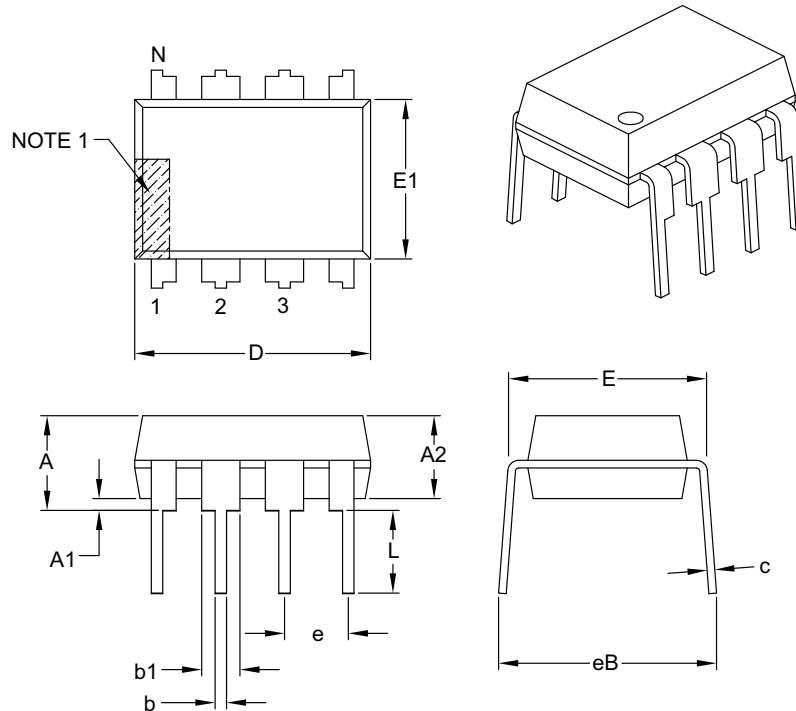

Dimension Limits	Units	INCHES		
		MIN	NOM	MAX
Number of Pins	N	8		
Pitch	e	.100 BSC		
Top to Seating Plane	A	–	–	.210
Molded Package Thickness	A2	.115	.130	.195
Base to Seating Plane	A1	.015	–	–
Shoulder to Shoulder Width	E	.290	.310	.325
Molded Package Width	E1	.240	.250	.280
Overall Length	D	.348	.365	.400
Tip to Seating Plane	L	.115	.130	.150
Lead Thickness	c	.008	.010	.015
Upper Lead Width	b1	.040	.060	.070
Lower Lead Width	b	.014	.018	.022
Overall Row Spacing §	eB	–	–	.430

**Notes:**

- Pin 1 visual index feature may vary, but must be located with the hatched area.
- § Significant Characteristic.
- Dimensions D and E1 do not include mold flash or protrusions. Mold flash or protrusions shall not exceed .010" per side.
- Dimensioning and tolerancing per ASME Y14.5M.

BSC: Basic Dimension. Theoretically exact value shown without tolerances.

Microchip Technology Drawing C04-018B

## 8-Lead Plastic Small Outline (OA) - Narrow, 3.90 mm Body [SOIC]

**Note:** For the most current package drawings, please see the Microchip Packaging Specification located at <http://www.microchip.com/packaging>

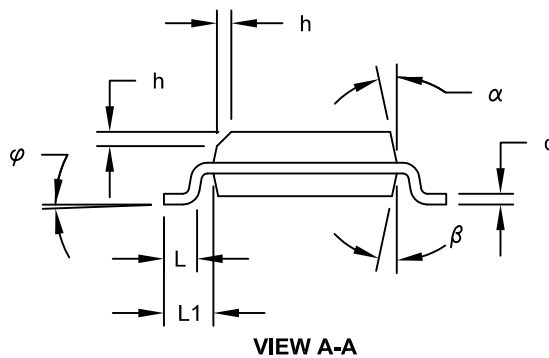
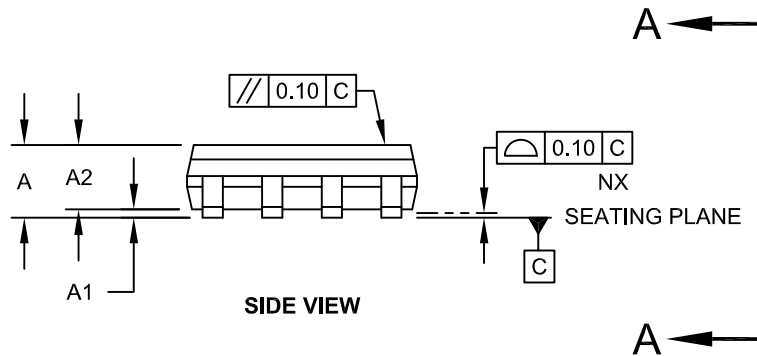
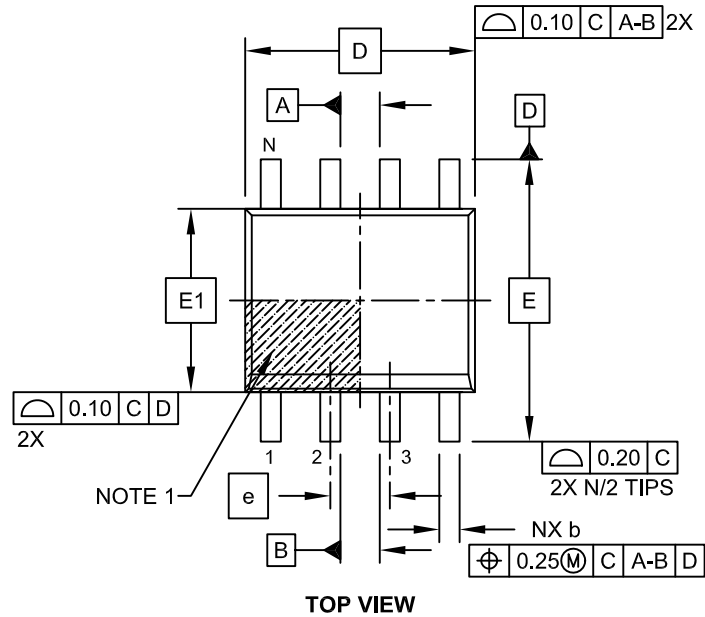

# TC620/TC621

## 8-Lead Plastic Small Outline (OA) - Narrow, 3.90 mm Body [SOIC]

**Note:** For the most current package drawings, please see the Microchip Packaging Specification located at <http://www.microchip.com/packaging>

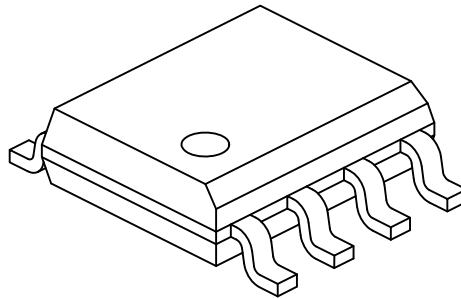

Dimension Limits	Units	MILLIMETERS		
		MIN	NOM	MAX
Number of Pins	N	8		
Pitch	e	1.27 BSC		
Overall Height	A	-	-	1.75
Molded Package Thickness	A2	1.25	-	-
Standoff §	A1	0.10	-	0.25
Overall Width	E	6.00 BSC		
Molded Package Width	E1	3.90 BSC		
Overall Length	D	4.90 BSC		
Chamfer (Optional)	h	0.25	-	0.50
Foot Length	L	0.40	-	1.27
Footprint	L1	1.04 REF		
Foot Angle	$\varphi$	0°	-	8°
Lead Thickness	c	0.17	-	0.25
Lead Width	b	0.31	-	0.51
Mold Draft Angle Top	$\alpha$	5°	-	15°
Mold Draft Angle Bottom	$\beta$	5°	-	15°

### Notes:

1. Pin 1 visual index feature may vary, but must be located within the hatched area.
2. § Significant Characteristic
3. Dimensions D and E1 do not include mold flash or protrusions. Mold flash or protrusions shall not exceed 0.15mm per side.
4. Dimensioning and tolerancing per ASME Y14.5M
  - BSC: Basic Dimension. Theoretically exact value shown without tolerances.
  - REF: Reference Dimension, usually without tolerance, for information purposes only.

Microchip Technology Drawing No. C04-057C Sheet 2 of 2

## 8-Lead Plastic Small Outline (OA) – Narrow, 3.90 mm Body [SOIC]

**Note:** For the most current package drawings, please see the Microchip Packaging Specification located at <http://www.microchip.com/packaging>

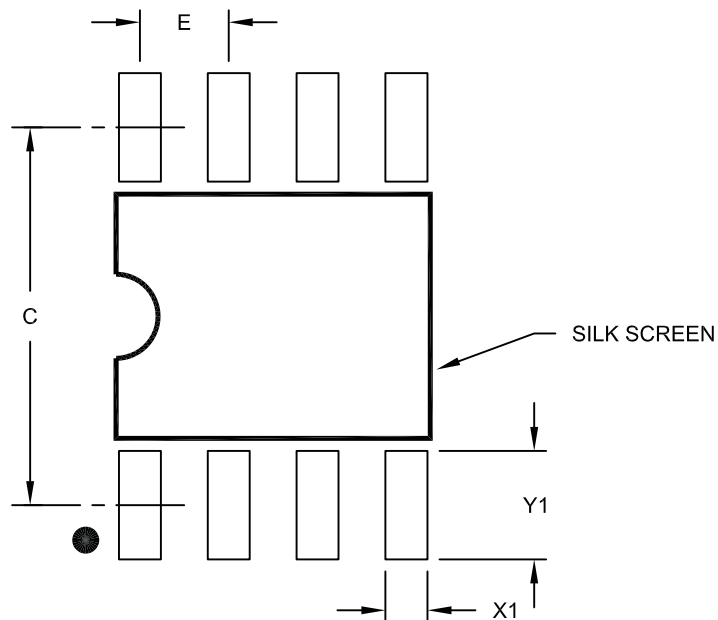

RECOMMENDED LAND PATTERN

Dimension Limits	Units	MILLIMETERS		
		MIN	NOM	MAX
Contact Pitch	E	1.27 BSC		
Contact Pad Spacing	C		5.40	
Contact Pad Width (X8)	X1			0.60
Contact Pad Length (X8)	Y1			1.55

**Notes:**

1. Dimensioning and tolerancing per ASME Y14.5M

BSC: Basic Dimension. Theoretically exact value shown without tolerances.

Microchip Technology Drawing No. C04-2057A

# TC620/TC621

---

NOTES:

## APPENDIX A: REVISION HISTORY

### Revision E (February 2015)

1. Removed the -55°C to 125°C temperature range reference on page 1.
2. Removed the M version temperature range from page 3 (-55°C to 125°C).
3. Added the [Temperature Characteristics](#) table.
4. Added **Section 5.0 “Packaging Information”**.
5. Added the [Product Identification System](#) section.

### Revision D (December 2012)

1. Added a note to each package outline drawing.

# TC620/TC621

---

NOTES:



## PRODUCT IDENTIFICATION SYSTEM

To order or obtain information, e.g., on pricing or delivery, refer to the factory or the listed sales office.

<u>PART NO.</u>	<u>X</u>	<u>X</u>	<u>XX</u>	<u>XXX</u>	<u>X</u>	<b>Examples:</b>																																																																						
Device	Cooling/ Heating	Temperature Range	Package	Tape & Reel	PB Free																																																																							
<table border="1" style="width: 100%; border-collapse: collapse;"> <tr> <td style="width: 20%;"><b>Device:</b></td> <td>TC620:</td> <td colspan="5">5V, Dual Trip Point Temperature Sensors</td> </tr> <tr> <td></td> <td>TC621:</td> <td colspan="5">5V, Dual Trip Point Temperature Sensors</td> </tr> <tr> <td><b>Cooling/Heating Option:</b></td> <td>C</td> <td>=</td> <td colspan="4">Cooling Option</td> </tr> <tr> <td></td> <td>H</td> <td>=</td> <td colspan="4">Heating Option</td> </tr> <tr> <td><b>Temperature Range:</b></td> <td>C</td> <td>=</td> <td colspan="4">0°C to +70°C (PDIP and SOIC only)</td> </tr> <tr> <td></td> <td>E</td> <td>=</td> <td colspan="4">-40°C to +85°C</td> </tr> <tr> <td></td> <td>V</td> <td>=</td> <td colspan="4">-40°C to +125°C</td> </tr> <tr> <td><b>Package:</b></td> <td>OA</td> <td>=</td> <td colspan="4">Plastic SOIC, (150 mil Body), 8-lead</td> </tr> <tr> <td></td> <td>OA713</td> <td>=</td> <td colspan="4">Plastic SOIC, (150 mil Body), 8-lead (Tape and Reel)</td> </tr> <tr> <td></td> <td>PA</td> <td>=</td> <td colspan="4">Plastic DIP (300 mil Body), 8-lead</td> </tr> </table>							<b>Device:</b>	TC620:	5V, Dual Trip Point Temperature Sensors						TC621:	5V, Dual Trip Point Temperature Sensors					<b>Cooling/Heating Option:</b>	C	=	Cooling Option					H	=	Heating Option				<b>Temperature Range:</b>	C	=	0°C to +70°C (PDIP and SOIC only)					E	=	-40°C to +85°C					V	=	-40°C to +125°C				<b>Package:</b>	OA	=	Plastic SOIC, (150 mil Body), 8-lead					OA713	=	Plastic SOIC, (150 mil Body), 8-lead (Tape and Reel)					PA	=	Plastic DIP (300 mil Body), 8-lead			
<b>Device:</b>	TC620:	5V, Dual Trip Point Temperature Sensors																																																																										
	TC621:	5V, Dual Trip Point Temperature Sensors																																																																										
<b>Cooling/Heating Option:</b>	C	=	Cooling Option																																																																									
	H	=	Heating Option																																																																									
<b>Temperature Range:</b>	C	=	0°C to +70°C (PDIP and SOIC only)																																																																									
	E	=	-40°C to +85°C																																																																									
	V	=	-40°C to +125°C																																																																									
<b>Package:</b>	OA	=	Plastic SOIC, (150 mil Body), 8-lead																																																																									
	OA713	=	Plastic SOIC, (150 mil Body), 8-lead (Tape and Reel)																																																																									
	PA	=	Plastic DIP (300 mil Body), 8-lead																																																																									
<table border="0" style="width: 100%;"> <tr> <td style="width: 5%;">a)</td> <td style="width: 20%;">TC620CCOA:</td> <td style="width: 15%;">5V Dual Trip Point</td> <td style="width: 15%;">Temp sensor,</td> <td style="width: 15%;">Cooling option,</td> <td style="width: 15%;">0°C to +70°C</td> <td style="width: 15%;">SOIC package</td> </tr> <tr> <td>b)</td> <td>TC620CEPA:</td> <td>5V Dual Trip Point</td> <td>Temp sensor,</td> <td>Cooling option,</td> <td>-40°C to +85°C</td> <td>PDIP package.</td> </tr> <tr> <td>c)</td> <td>TC620CVPA:</td> <td>5V Dual Trip Point</td> <td>Temp sensor,</td> <td>Cooling option,</td> <td>-40°C to +125°C</td> <td>PDIP package.</td> </tr> <tr> <td>d)</td> <td>TC620HCOA:</td> <td>5V Dual Trip Point</td> <td>Temp sensor,</td> <td>Heating option,</td> <td>0°C to +70°C</td> <td>SOIC package</td> </tr> <tr> <td>e)</td> <td>TC621HEPA:</td> <td>5V Dual Trip Point</td> <td>Temp sensor,</td> <td>Heating option,</td> <td>-40°C to +85°C</td> <td>PDIP package.</td> </tr> <tr> <td>f)</td> <td>TC620CCOA713:</td> <td>5V Dual Trip Point</td> <td>Temp sensor,</td> <td>Cooling option,</td> <td>0°C to +70°C</td> <td>SOIC package.</td> </tr> <tr> <td>g)</td> <td>TC621HCOA713:</td> <td>5V Dual Trip Point</td> <td>Temp sensor,</td> <td>Heating option,</td> <td>0°C to +70°C</td> <td>SOIC package.</td> </tr> </table>							a)	TC620CCOA:	5V Dual Trip Point	Temp sensor,	Cooling option,	0°C to +70°C	SOIC package	b)	TC620CEPA:	5V Dual Trip Point	Temp sensor,	Cooling option,	-40°C to +85°C	PDIP package.	c)	TC620CVPA:	5V Dual Trip Point	Temp sensor,	Cooling option,	-40°C to +125°C	PDIP package.	d)	TC620HCOA:	5V Dual Trip Point	Temp sensor,	Heating option,	0°C to +70°C	SOIC package	e)	TC621HEPA:	5V Dual Trip Point	Temp sensor,	Heating option,	-40°C to +85°C	PDIP package.	f)	TC620CCOA713:	5V Dual Trip Point	Temp sensor,	Cooling option,	0°C to +70°C	SOIC package.	g)	TC621HCOA713:	5V Dual Trip Point	Temp sensor,	Heating option,	0°C to +70°C	SOIC package.																					
a)	TC620CCOA:	5V Dual Trip Point	Temp sensor,	Cooling option,	0°C to +70°C	SOIC package																																																																						
b)	TC620CEPA:	5V Dual Trip Point	Temp sensor,	Cooling option,	-40°C to +85°C	PDIP package.																																																																						
c)	TC620CVPA:	5V Dual Trip Point	Temp sensor,	Cooling option,	-40°C to +125°C	PDIP package.																																																																						
d)	TC620HCOA:	5V Dual Trip Point	Temp sensor,	Heating option,	0°C to +70°C	SOIC package																																																																						
e)	TC621HEPA:	5V Dual Trip Point	Temp sensor,	Heating option,	-40°C to +85°C	PDIP package.																																																																						
f)	TC620CCOA713:	5V Dual Trip Point	Temp sensor,	Cooling option,	0°C to +70°C	SOIC package.																																																																						
g)	TC621HCOA713:	5V Dual Trip Point	Temp sensor,	Heating option,	0°C to +70°C	SOIC package.																																																																						

# TC620/TC621

---

NOTES:

---

**Note the following details of the code protection feature on Microchip devices:**

- Microchip products meet the specification contained in their particular Microchip Data Sheet.
- Microchip believes that its family of products is one of the most secure families of its kind on the market today, when used in the intended manner and under normal conditions.
- There are dishonest and possibly illegal methods used to breach the code protection feature. All of these methods, to our knowledge, require using the Microchip products in a manner outside the operating specifications contained in Microchip's Data Sheets. Most likely, the person doing so is engaged in theft of intellectual property.
- Microchip is willing to work with the customer who is concerned about the integrity of their code.
- Neither Microchip nor any other semiconductor manufacturer can guarantee the security of their code. Code protection does not mean that we are guaranteeing the product as “unbreakable.”

Code protection is constantly evolving. We at Microchip are committed to continuously improving the code protection features of our products. Attempts to break Microchip's code protection feature may be a violation of the Digital Millennium Copyright Act. If such acts allow unauthorized access to your software or other copyrighted work, you may have a right to sue for relief under that Act.

---

Information contained in this publication regarding device applications and the like is provided only for your convenience and may be superseded by updates. It is your responsibility to ensure that your application meets with your specifications. MICROCHIP MAKES NO REPRESENTATIONS OR WARRANTIES OF ANY KIND WHETHER EXPRESS OR IMPLIED, WRITTEN OR ORAL, STATUTORY OR OTHERWISE, RELATED TO THE INFORMATION, INCLUDING BUT NOT LIMITED TO ITS CONDITION, QUALITY, PERFORMANCE, MERCHANTABILITY OR FITNESS FOR PURPOSE. Microchip disclaims all liability arising from this information and its use. Use of Microchip devices in life support and/or safety applications is entirely at the buyer's risk, and the buyer agrees to defend, indemnify and hold harmless Microchip from any and all damages, claims, suits, or expenses resulting from such use. No licenses are conveyed, implicitly or otherwise, under any Microchip intellectual property rights.

**Trademarks**

The Microchip name and logo, the Microchip logo, dsPIC, FlashFlex, flexPWR, JukeBlox, KEELOQ, KEELOQ logo, Klear, LANCheck, MediaLB, MOST, MOST logo, MPLAB, OptoLyzer, PIC, PICSTART, PIC<sup>32</sup> logo, RightTouch, SpyNIC, SST, SST Logo, SuperFlash and UNI/O are registered trademarks of Microchip Technology Incorporated in the U.S.A. and other countries.

The Embedded Control Solutions Company and mTouch are registered trademarks of Microchip Technology Incorporated in the U.S.A.

Analog-for-the-Digital Age, BodyCom, chipKIT, chipKIT logo, CodeGuard, dsPICDEM, dsPICDEM.net, ECAN, In-Circuit Serial Programming, ICSP, Inter-Chip Connectivity, KlearNet, KlearNet logo, MiWi, MPASM, MPF, MPLAB Certified logo, MPLIB, MPLINK, MultiTRAK, NetDetach, Omniscient Code Generation, PICDEM, PICDEM.net, PICkit, PICtail, RightTouch logo, REAL ICE, SQI, Serial Quad I/O, Total Endurance, TSHARC, USBCheck, VariSense, ViewSpan, WiperLock, Wireless DNA, and ZENA are trademarks of Microchip Technology Incorporated in the U.S.A. and other countries.

SQTP is a service mark of Microchip Technology Incorporated in the U.S.A.

Silicon Storage Technology is a registered trademark of Microchip Technology Inc. in other countries.

GestIC is a registered trademarks of Microchip Technology Germany II GmbH & Co. KG, a subsidiary of Microchip Technology Inc., in other countries.

All other trademarks mentioned herein are property of their respective companies.

© 2001-2015, Microchip Technology Incorporated, Printed in the U.S.A., All Rights Reserved.

ISBN: 978-1-63277-119-3

**QUALITY MANAGEMENT SYSTEM**  
**CERTIFIED BY DNV**  
**== ISO/TS 16949 ==**

*Microchip received ISO/TS-16949:2009 certification for its worldwide headquarters, design and wafer fabrication facilities in Chandler and Tempe, Arizona; Gresham, Oregon and design centers in California and India. The Company's quality system processes and procedures are for its PIC<sup>®</sup> MCUs and dsPIC<sup>®</sup> DSCs, KEELOQ<sup>®</sup> code hopping devices, Serial EEPROMs, microperipherals, nonvolatile memory and analog products. In addition, Microchip's quality system for the design and manufacture of development systems is ISO 9001:2000 certified.*



# MICROCHIP

## Worldwide Sales and Service

### AMERICAS

**Corporate Office**  
2355 West Chandler Blvd.  
Chandler, AZ 85224-6199  
Tel: 480-792-7200  
Fax: 480-792-7277  
Technical Support:  
<http://www.microchip.com/support>  
Web Address:  
[www.microchip.com](http://www.microchip.com)

**Atlanta**  
Duluth, GA  
Tel: 678-957-9614  
Fax: 678-957-1455

**Austin, TX**  
Tel: 512-257-3370

**Boston**  
Westborough, MA  
Tel: 774-760-0087  
Fax: 774-760-0088

**Chicago**  
Itasca, IL  
Tel: 630-285-0071  
Fax: 630-285-0075

**Cleveland**  
Independence, OH  
Tel: 216-447-0464  
Fax: 216-447-0643

**Dallas**  
Addison, TX  
Tel: 972-818-7423  
Fax: 972-818-2924

**Detroit**  
Novi, MI  
Tel: 248-848-4000

**Houston, TX**  
Tel: 281-894-5983  
Indianapolis

**Noblesville, IN**  
Tel: 317-773-8323  
Fax: 317-773-5453

**Los Angeles**  
Mission Viejo, CA  
Tel: 949-462-9523  
Fax: 949-462-9608

**New York, NY**  
Tel: 631-435-6000

**San Jose, CA**  
Tel: 408-735-9110

**Canada - Toronto**  
Tel: 905-673-0699  
Fax: 905-673-6509

### ASIA/PACIFIC

**Asia Pacific Office**  
Suites 3707-14, 37th Floor  
Tower 6, The Gateway  
Harbour City, Kowloon

**Hong Kong**  
Tel: 852-2943-5100  
Fax: 852-2401-3431

**Australia - Sydney**  
Tel: 61-2-9868-6733  
Fax: 61-2-9868-6755

**China - Beijing**  
Tel: 86-10-8569-7000  
Fax: 86-10-8528-2104

**China - Chengdu**  
Tel: 86-28-8665-5511  
Fax: 86-28-8665-7889

**China - Chongqing**  
Tel: 86-23-8980-9588  
Fax: 86-23-8980-9500

**China - Dongguan**  
Tel: 86-769-8702-9880

**China - Hangzhou**  
Tel: 86-571-8792-8115  
Fax: 86-571-8792-8116

**China - Hong Kong SAR**  
Tel: 852-2943-5100  
Fax: 852-2401-3431

**China - Nanjing**  
Tel: 86-25-8473-2460  
Fax: 86-25-8473-2470

**China - Qingdao**  
Tel: 86-532-8502-7355  
Fax: 86-532-8502-7205

**China - Shanghai**  
Tel: 86-21-5407-5533  
Fax: 86-21-5407-5066

**China - Shenyang**  
Tel: 86-24-2334-2829  
Fax: 86-24-2334-2393

**China - Shenzhen**  
Tel: 86-755-8864-2200  
Fax: 86-755-8203-1760

**China - Wuhan**  
Tel: 86-27-5980-5300  
Fax: 86-27-5980-5118

**China - Xian**  
Tel: 86-29-8833-7252  
Fax: 86-29-8833-7256

### ASIA/PACIFIC

**China - Xiamen**  
Tel: 86-592-2388138  
Fax: 86-592-2388130

**China - Zhuhai**  
Tel: 86-756-3210040  
Fax: 86-756-3210049

**India - Bangalore**  
Tel: 91-80-3090-4444  
Fax: 91-80-3090-4123

**India - New Delhi**  
Tel: 91-11-4160-8631  
Fax: 91-11-4160-8632

**India - Pune**  
Tel: 91-20-3019-1500

**Japan - Osaka**  
Tel: 81-6-6152-7160  
Fax: 81-6-6152-9310

**Japan - Tokyo**  
Tel: 81-3-6880-3770  
Fax: 81-3-6880-3771

**Korea - Daegu**  
Tel: 82-53-744-4301  
Fax: 82-53-744-4302

**Korea - Seoul**  
Tel: 82-2-554-7200  
Fax: 82-2-558-5932 or  
82-2-558-5934

**Malaysia - Kuala Lumpur**  
Tel: 60-3-6201-9857  
Fax: 60-3-6201-9859

**Malaysia - Penang**  
Tel: 60-4-227-8870  
Fax: 60-4-227-4068

**Philippines - Manila**  
Tel: 63-2-634-9065  
Fax: 63-2-634-9069

**Singapore**  
Tel: 65-6334-8870  
Fax: 65-6334-8850

**Taiwan - Hsin Chu**  
Tel: 886-3-5778-366  
Fax: 886-3-5770-955

**Taiwan - Kaohsiung**  
Tel: 886-7-213-7828

**Taiwan - Taipei**  
Tel: 886-2-2508-8600  
Fax: 886-2-2508-0102

**Thailand - Bangkok**  
Tel: 66-2-694-1351  
Fax: 66-2-694-1350

### EUROPE

**Austria - Wels**  
Tel: 43-7242-2244-39  
Fax: 43-7242-2244-393

**Denmark - Copenhagen**  
Tel: 45-4450-2828  
Fax: 45-4485-2829

**France - Paris**  
Tel: 33-1-69-53-63-20  
Fax: 33-1-69-30-90-79

**Germany - Dusseldorf**  
Tel: 49-2129-3766400

**Germany - Munich**  
Tel: 49-89-627-144-0  
Fax: 49-89-627-144-44

**Germany - Pforzheim**  
Tel: 49-7231-424750

**Italy - Milan**  
Tel: 39-0331-742611  
Fax: 39-0331-466781

**Italy - Venice**  
Tel: 39-049-7625286

**Netherlands - Drunen**  
Tel: 31-416-690399  
Fax: 31-416-690340

**Poland - Warsaw**  
Tel: 48-22-3325737

**Spain - Madrid**  
Tel: 34-91-708-08-90  
Fax: 34-91-708-08-91

**Sweden - Stockholm**  
Tel: 46-8-5090-4654

**UK - Wokingham**  
Tel: 44-118-921-5800  
Fax: 44-118-921-5820

01/27/15