

ELM85xxxxA CMOS 600mA/800mA LDO voltage regulator

<http://www.elm-tech.com>

■General description

ELM85xxxxA is CMOS voltage regulator which is characterized with high current and low dropout (55mV at $I_{out}=100mA$). There are 2 types of CE selection of ELM85 series: non-chip enable function and “H” active. The standard output voltages are 3.0V, 3.3V, 5.0V. ELM85 series can also be made as semi-custom IC within the range of 0.8V to 5.0V by 0.1V step. This series also includes short circuit current limiter and thermal shutdown circuit. Ceramic capacitors with low ESR can be used as input and output ones.

■Features

- Output voltage range : 0.8V to 5.0V (by 0.1V)
- Output current : 600mA($V_{out}<3.0V$)
800mA($V_{out}\geq 3.0V$)
- Current consumption : Typ.40 μ A
- Input stability : Typ.0.02%/V
- Load stability : Typ.20mV($1mA\leq I_{out}\leq 300mA$)
- Accuracy of output voltage : $\pm 2.0\%$
- Input-output voltage difference : Typ.55mV($V_{out}=3.0V, I_{out}=100mA$)
- Short circuit current limiter : Typ.70mA($V_{out}=0V$)
- Package : SOT-223(0.8V to 5.0V), SON8-3x3(1.2V to 4.0V)
SOT-89(1.2V to 4.0V), SOT-89-5(1.2V to 4.0V)
SOT-23(1.2V to 4.0V), SOT-25(1.2V to 4.0V)
(0.8V to 1.1V, 4.1V to 5.0V are available in SOT-223 package only.)

■Application

- Battery operated devices
- Portable AV equipments

■Maximum absolute ratings

Parameter	Symbol	Limit	Unit
Input voltage	V_{in}	$V_{ss}-0.3$ to 7.0	V
Output voltage	V_{out}	$V_{ss}-0.3$ to $V_{in}+0.3$	V
Output current	I_{out}	1000	mA
Power dissipation	P_d	500 (SOT-89)	mW
		500 (SOT-89-5)	
		250 (SOT-23)	
		300 (SOT-25)	
		500 (SON8-3x3)	
		625 (SOT-223)	
Operating temperature	T_{op}	-40 to +85	$^{\circ}C$
Storage temperature	T_{stg}	-55 to +125	$^{\circ}C$

ELM85xxxxA CMOS 600mA/800mA LDO voltage regulator

<http://www.elm-tech.com>

■ Selection guide

ELM85xxxxA-x

Symbol		
a, b	Output voltage	e.g. : 30: Vout=3.0V, 33: Vout=3.3V 50: Vout=5.0V
c	CE selection	1: NO CE 3: CE="H" active
d	Package	A: SOT-89, SOT-89-5 B: SOT-23, SOT-25 G: SON8-3x3 H: SOT-223
e	Product version	A
f	Taping direction	S: Refer to PKG file (SOT-223: S only) N: Refer to PKG file

ELM85 x x x x A - x
 ↑ ↑ ↑ ↑ ↑ ↑
 a b c d e f

■ Pin configuration

SOT-223(TOP VIEW)

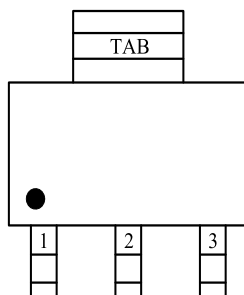

ELM85xx1HA

Pin No.	Pin name
1	VSS
2/TAB	VIN
3	VOUT

SOT-89(TOP VIEW)

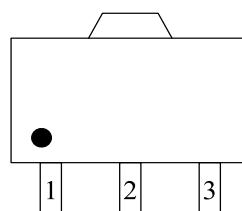

ELM85xx1AA

Pin No.	Pin name
1	VSS
2	VIN
3	VOUT

SOT-89-5(TOP VIEW)

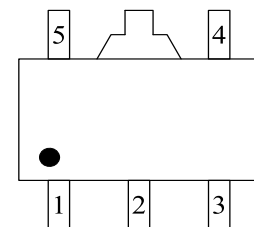

ELM85xx3AA

Pin No.	Pin name
1	VSS
2	VIN
3	VOUT
4	NC
5	CE

SOT-23(TOP VIEW)

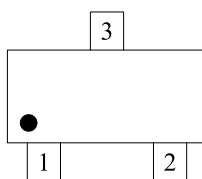

ELM85xx1BA

Pin No.	Pin name
1	VSS
2	VOUT
3	VIN

SOT-25(TOP VIEW)

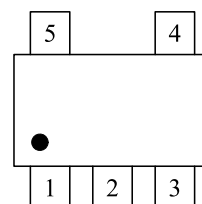

ELM85xx3BA

Pin No.	Pin name
1	VIN
2	VSS
3	CE
4	NC
5	VOUT

ELM85xxxxA CMOS 600mA/800mA LDO voltage regulator

<http://www.elm-tech.com>

SON8-3x3(TOP VIEW)

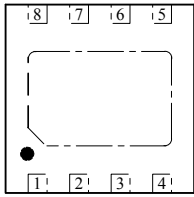

SON8-3x3(BOTTOM VIEW)

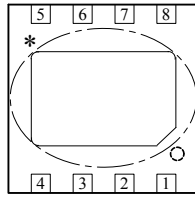

ELM85xx3GA

Pin No.	Pin name	Pin No.	Pin name
1	VOUT	5	NC
2	VOUT	6	CE
3	VIN	7	NC
4	VIN	8	VSS

* The potential of the tab on the back is the circuit one (VIN). Please set it to be open or connect to VIN pin(recommended).

Standard circuit

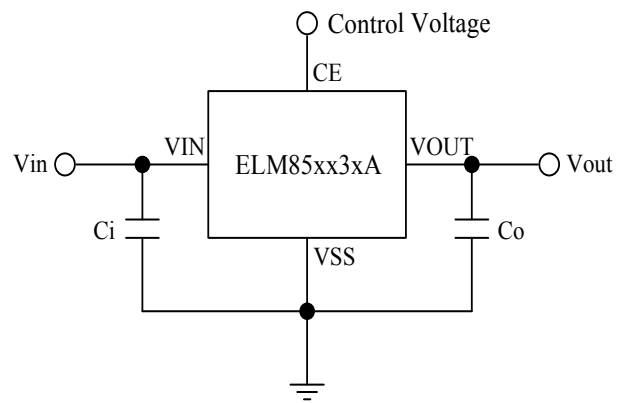
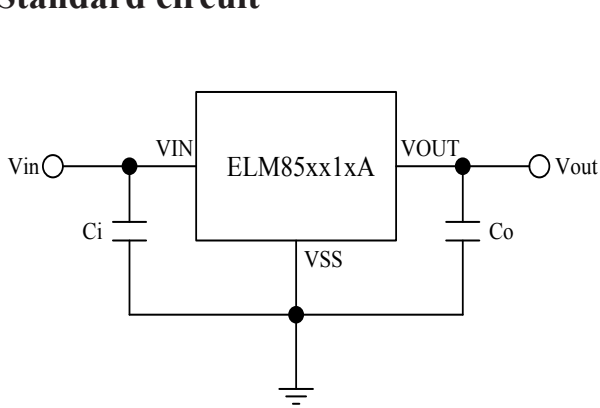

Block diagram

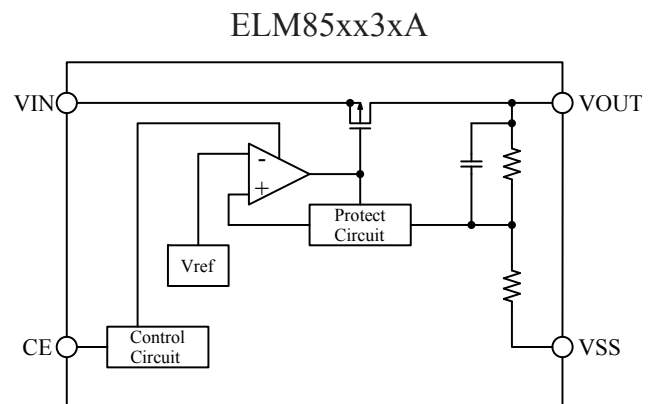
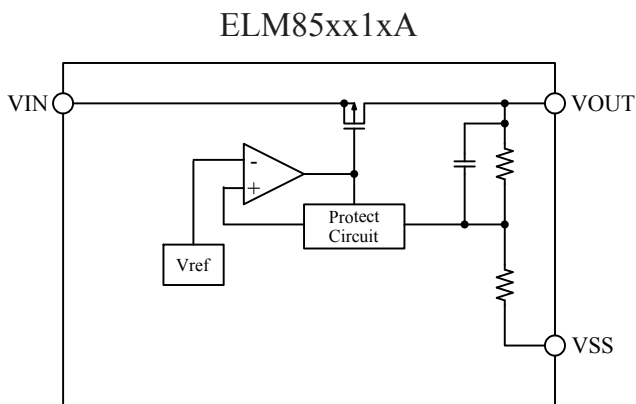

ELM85xxxxA CMOS 600mA/800mA LDO voltage regulator

http://www.elm-tech.com

■Electrical characteristics (ELM85xx1xA)

Vout=3.0V(ELM85301xA), No CE pin

Ci=1.0μF, Co=4.7μF, Top=25°C

Parameter	Symbol	Condition	Min.	Typ.	Max.	Unit
Output voltage	Vout	Vin=4.0V, Iout=40mA	2.940	3.000	3.060	V
Output current	Iout	Vin=4.0V	800			mA
Input stability	$\Delta V_{out}/\Delta V_{in}$	3.5V≤Vin≤6.0V, Iout=100mA		0.02	0.20	%/V
Load stability	$\Delta V_{out}/\Delta I_{out}$	Vin=4.0V, 1mA≤Iout≤300mA		20	60	mV
Input-Output voltage differential	Vdif	Iout=100mA		55	90	mV
Current consumption	Iss	Vin=4.0V		40	100	μA
Input voltage	Vin		1.4		6.0	V
Output voltage temperature coefficient	$\Delta V_{out}/\Delta T_{op}$	-40°C≤Top≤+85°C, Vin=4.0V, Iout=40mA		±100		ppm/°C
Short circuit current	Ilim	Vout=0V		70		mA
Ripple rejection ratio	RR	f=1kHz, Iout=40mA		60		dB
Thermal shutdown temperature	Tsd			165		°C
Output noise	Vno	BW=10Hz to 100kHz		30		μVrms

Vout=3.3V(ELM85331xA), No CE pin

Ci=1.0μF, Co=4.7μF, Top=25°C

Parameter	Symbol	Condition	Min.	Typ.	Max.	Unit
Output voltage	Vout	Vin=4.3V, Iout=40mA	3.234	3.300	3.366	V
Output current	Iout	Vin=4.3V	800			mA
Input stability	$\Delta V_{out}/\Delta V_{in}$	3.8V≤Vin≤6.0V, Iout=100mA		0.02	0.20	%/V
Load stability	$\Delta V_{out}/\Delta I_{out}$	Vin=4.3V, 1mA≤Iout≤300mA		20	60	mV
Input-Output voltage differential	Vdif	Iout=100mA		55	90	mV
Current consumption	Iss	Vin=4.3V		40	100	μA
Input voltage	Vin		1.4		6.0	V
Output voltage temperature coefficient	$\Delta V_{out}/\Delta T_{op}$	-40°C≤Top≤+85°C, Vin=4.3V, Iout=40mA		±100		ppm/°C
Short circuit current	Ilim	Vout=0V		70		mA
Ripple rejection ratio	RR	f=1kHz, Iout=40mA		60		dB
Thermal shutdown temperature	Tsd			165		°C
Output noise	Vno	BW=10Hz to 100kHz		30		μVrms

ELM85xxxxA CMOS 600mA/800mA LDO voltage regulator

http://www.elm-tech.com

Vout=5.0V(ELM85501HA), No CE pin

Ci=1.0μF, Co=4.7μF, Top=25°C

Parameter	Symbol	Condition	Min.	Typ.	Max.	Unit
Output voltage	Vout	Vin=6.0V, Iout=40mA	4.900	5.000	5.100	V
Output current	Iout	Vin=6.0V	800			mA
Input stability	$\Delta V_{out}/\Delta V_{in}$	5.5V≤Vin≤6.0V, Iout=100mA		0.02	0.20	%/V
Load stability	$\Delta V_{out}/\Delta I_{out}$	Vin=6.0V, 1mA≤Iout≤300mA		20	60	mV
Input-Output voltage differential	Vdif	Iout=100mA		52	85	mV
Current consumption	Iss	Vin=6.0V		40	100	μA
Input voltage	Vin		1.4		6.0	V
Output voltage temperature coefficient	$\Delta V_{out}/\Delta T_{op}$	-40°C≤Top≤+85°C, Vin=6.0V, Iout=40mA		±100		ppm/°C
Short circuit current	Ilim	Vout=0V		70		mA
Ripple rejection ratio	RR	f=1kHz, Iout=40mA		60		dB
Thermal shutdown temperature	Tsd			165		°C
Output noise	Vno	BW=10Hz to 100kHz		30		μVrms

* ELM8550 is only available in SOT-223 package.

■Electrical characteristics (ELM85xx3AA)

Vout=3.0V(ELM85303AA), CE="H" active

Ci=1.0μF, Co=4.7μF, Top=25°C

Parameter	Symbol	Condition	Min.	Typ.	Max.	Unit
Output voltage	Vout	Vin=4.0V, Iout=40mA	2.940	3.000	3.060	V
Output current	Iout	Vin=4.0V	800			mA
Input stability	$\Delta V_{out}/\Delta V_{in}$	3.5V≤Vin≤6.0V, Iout=100mA		0.02	0.20	%/V
Load stability	$\Delta V_{out}/\Delta I_{out}$	Vin=4.0V, 1mA≤Iout≤300mA		20	60	mV
Input-Output voltage differential	Vdif	Iout=100mA		55	90	mV
Current consumption	Iss	Vin=4.0V		40	100	μA
Standby current consumption	Istandby	Vin=4.0V, Vce=0V			0.5	μA
Input voltage	Vin		1.4		6.0	V
CE input voltage High	Vceh	Vin=6.0V	1.8		Vin	V
CE input voltage Low	Vcel	Vin=1.4V	0.0		0.2	V
CE input current High	Iceh	Vce=Vin=6.0V	-0.2		0.2	μA
CE input current Low	Icel	Vce=Vss, Vin=6.0V	-0.2		0.2	μA
Output voltage temperature coefficient	$\Delta V_{out}/\Delta T_{op}$	-40°C≤Top≤+85°C, Vin=4.0V, Iout=40mA		±100		ppm/°C
Short circuit current	Ilim	Vout=0V		70		mA
Ripple rejection ratio	RR	f=1kHz, Iout=40mA		60		dB
Thermal shutdown temperature	Tsd			165		°C
Output noise	Vno	BW=10Hz to 100kHz		30		μVrms

ELM85xxxxA CMOS 600mA/800mA LDO voltage regulator

http://www.elm-tech.com

Vout=3.3V(ELM85333AA), CE="H" active

Ci=1.0μF, Co=4.7μF, Top=25°C

Parameter	Symbol	Condition	Min.	Typ.	Max.	Unit
Output voltage	Vout	Vin=4.3V, Iout=40mA	3.234	3.300	3.366	V
Output current	Iout	Vin=4.3V	800			mA
Input stability	$\Delta V_{out}/\Delta V_{in}$	3.8V≤Vin≤6.0V, Iout=100mA		0.02	0.20	%/V
Load stability	$\Delta V_{out}/\Delta I_{out}$	Vin=4.3V, 1mA≤Iout≤300mA		20	60	mV
Input-Output voltage differential	Vdif	Iout=100mA		55	90	mV
Current consumption	I _{ss}	Vin=4.3V		40	100	μA
Standby current consumption	I _{standby}	Vin=4.3V, Vce=0V			0.5	μA
Input voltage	Vin		1.4		6.0	V
CE input voltage High	Vceh	Vin=6.0V	1.8		Vin	V
CE input voltage Low	Vcel	Vin=1.4V	0.0		0.2	V
CE input current High	Iceh	Vce=Vin=6.0V	-0.2		0.2	μA
CE input current Low	Icel	Vce=V _{ss} , Vin=6.0V	-0.2		0.2	μA
Output voltage temperature coefficient	$\Delta V_{out}/\Delta T_{op}$	-40°C≤Top≤+85°C, Vin=4.3V, Iout=40mA		±100		ppm/°C
Short circuit current	I _{lim}	Vout=0V		70		mA
Ripple rejection ratio	RR	f=1kHz, Iout=40mA		60		dB
Thermal shutdown temperature	T _{sd}			165		°C
Output noise	V _{no}	BW=10Hz to 100kHz		30		μV _{rms}

■Electrical characteristics (ELM8533xGA)

Vout=3.3V(ELM85333GA), CE="H" active

Ci=1.0μF, Co=4.7μF, Top=25°C

Parameter	Symbol	Condition	Min.	Typ.	Max.	Unit
Output voltage	Vout	Vin=4.3V, Iout=40mA	3.234	3.300	3.366	V
Output current	Iout	Vin=4.3V	800			mA
Input stability	$\Delta V_{out}/\Delta V_{in}$	3.8V≤Vin≤6.0V, Iout=100mA		0.02	0.20	%/V
Load stability	$\Delta V_{out}/\Delta I_{out}$	Vin=4.3V, 1mA≤Iout≤300mA		20	60	mV
Input-Output voltage differential	Vdif	Iout=100mA		55	90	mV
Current consumption	I _{ss}	Vin=4.3V		40	100	μA
Standby current consumption	I _{standby}	Vin=4.3V, Vce=0V			0.5	μA
Input voltage	Vin		1.4		6.0	V
CE input voltage High	Vceh	Vin=6.0V	1.8		Vin	V
CE input voltage Low	Vcel	Vin=1.4V	0.0		0.2	V
CE input current High	Iceh	Vce=Vin=6.0V	-0.2		0.2	μA
CE input current Low	Icel	Vce=V _{ss} , Vin=6.0V	-0.2		0.2	μA
Output voltage temperature coefficient	$\Delta V_{out}/\Delta T_{op}$	-40°C≤Top≤+85°C, Vin=4.3V, Iout=40mA		±100		ppm/°C
Short circuit current	I _{lim}	Vout=0V		70		mA
Ripple rejection ratio	RR	f=1kHz, Iout=40mA		60		dB
Thermal shutdown temperature	T _{sd}			165		°C
Output noise	V _{no}	BW=10Hz to 100kHz		30		μV _{rms}

ELM85xxxxA CMOS 600mA/800mA LDO voltage regulator

<http://www.elm-tech.com>

■ Marking

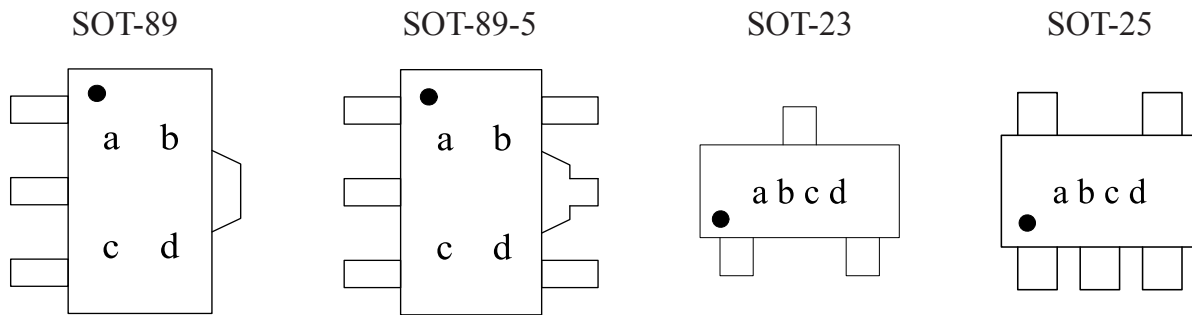

a, b : Represents Output voltage range , Package type and CE type.

Symbol	Output voltage range (V)	Package	CE Type
00	1.2~3.0	SOT-89	No CE
01	3.1~4.0	SOT-89	No CE
02	1.2~3.0	SOT-89-5	CE=High
03	3.1~4.0	SOT-89-5	CE=High
54	1.2~3.0	SOT-23	No CE
55	3.1~4.0	SOT-23	No CE
5Y	1.2~3.0	SOT-25	CE=High
5Z	3.1~4.0	SOT-25	CE=High

c : Represents Output voltage.

Symbol	Output voltage(V)		Symbol	Output voltage(V)	
1		3.1	F	1.6	
2		3.2	G	1.7	
3		3.3	H	1.8	
4		3.4	J	1.9	
5		3.5	K	2.0	
6		3.6	L	2.1	
7		3.7	M	2.2	
8		3.8	N	2.3	
9		3.9	P	2.4	
0		4.0	Q	2.5	
A			R	2.6	
B	1.2		S	2.7	
C	1.3		T	2.8	
D	1.4		U	2.9	
E	1.5		V	3.0	

d : Represents the assembly lot number
1~0, A~Z repeated (I,O,X excepted)

ELM85xxxxA CMOS 600mA/800mA LDO voltage regulator

<http://www.elm-tech.com>

SON8-3x3

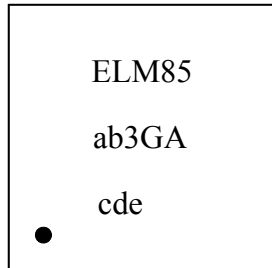

a, b : Output voltage. e.g. : 33(Vout=3.3V)
c to e : Assembly lot No. — 000 to 999

SOT-223

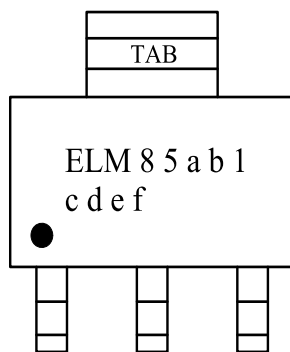

a, b : Output voltage. e.g. : 33(Vout=3.3V)
c : Product version
d to f : Assembly lot No. —
A to Z (I, O, X excepted) and 0 to 9

ELM85xxxxA CMOS 600mA/800mA LDO voltage regulator

<http://www.elm-tech.com>

■ Typical characteristics

- 3.0V Vout unit (ELM8530xxA)

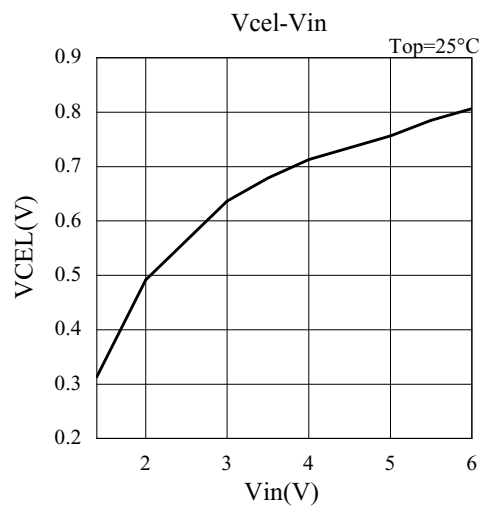
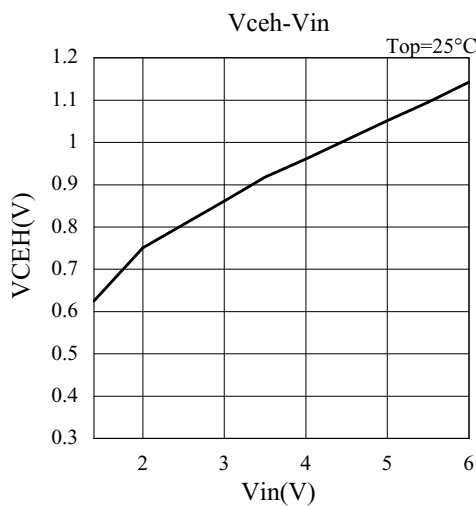
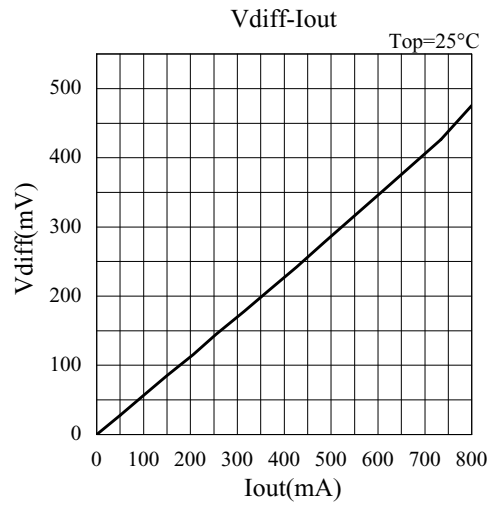
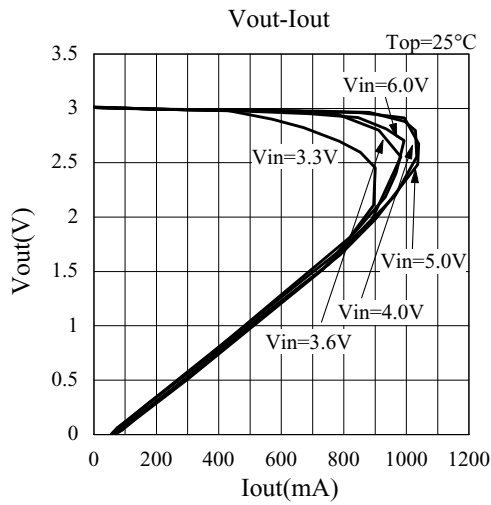
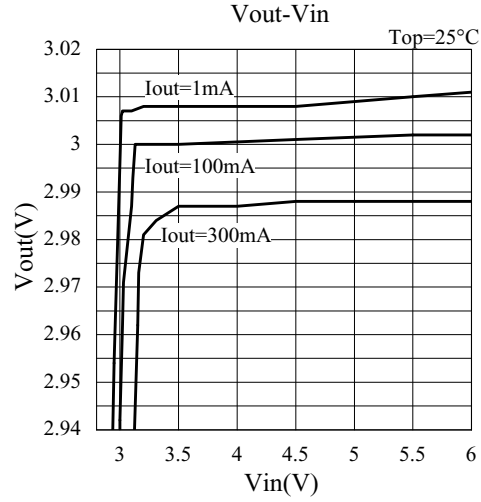
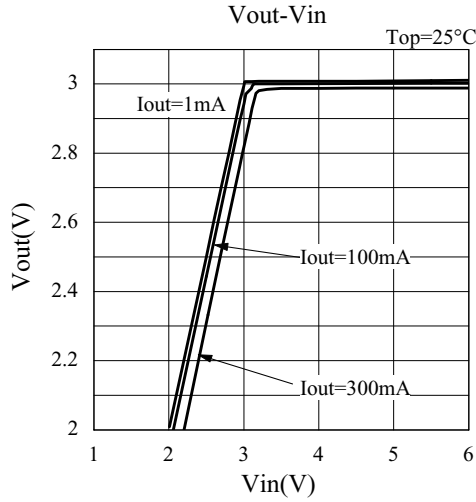

ELM85xxxxA CMOS 600mA/800mA LDO voltage regulator

<http://www.elm-tech.com>

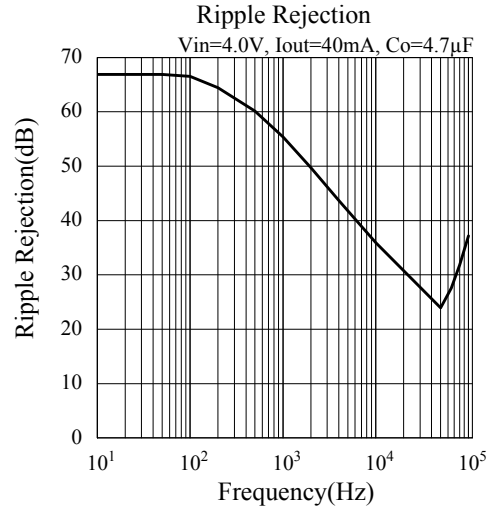
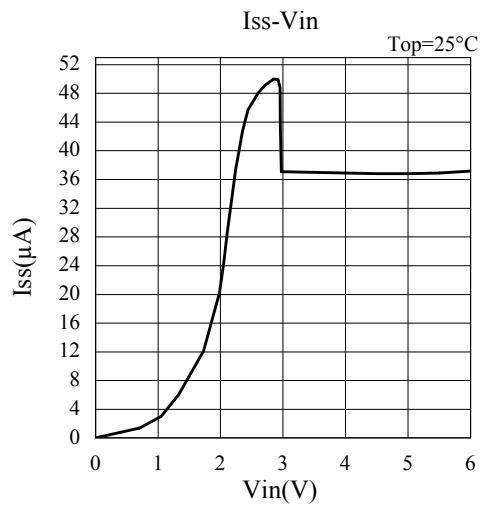
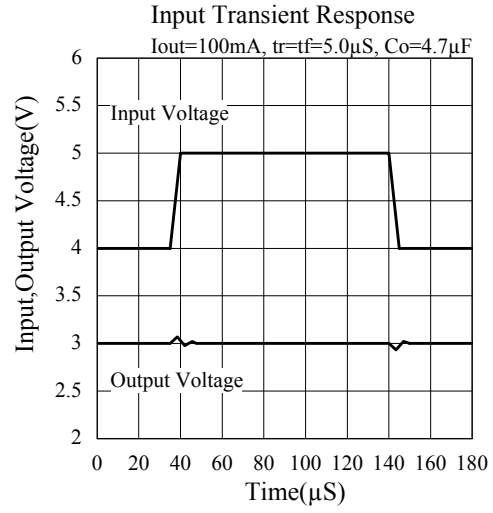
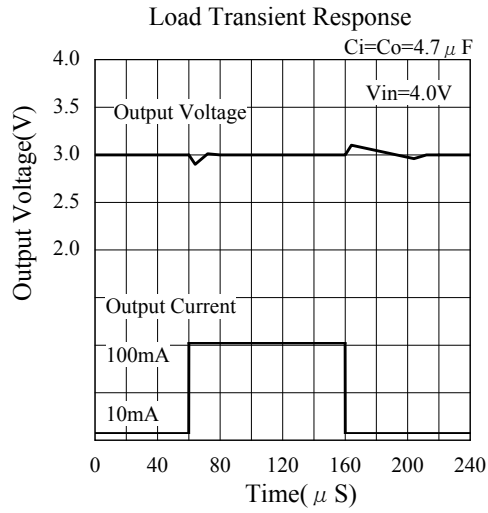

ELM85xxxxA CMOS 600mA/800mA LDO voltage regulator

<http://www.elm-tech.com>

- 3.3V Vout unit (ELM8533xxA)

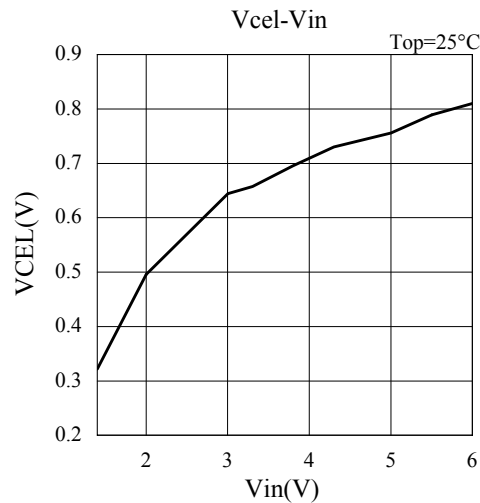
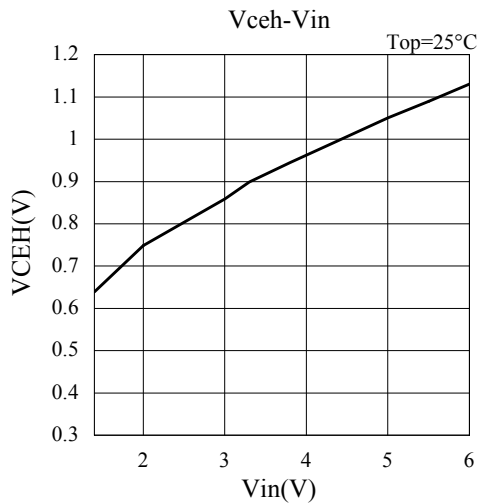
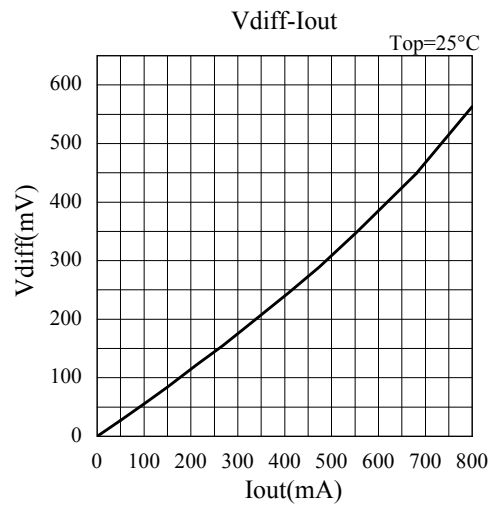
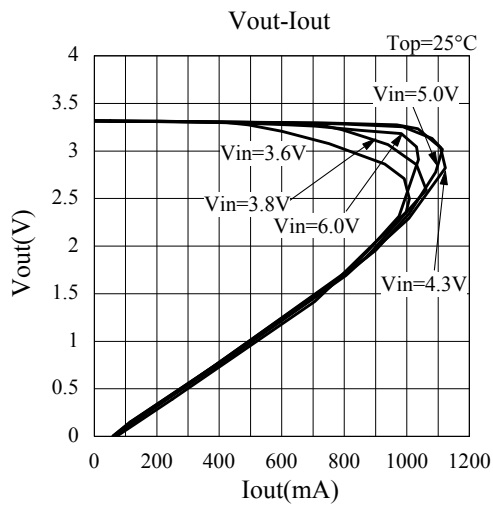
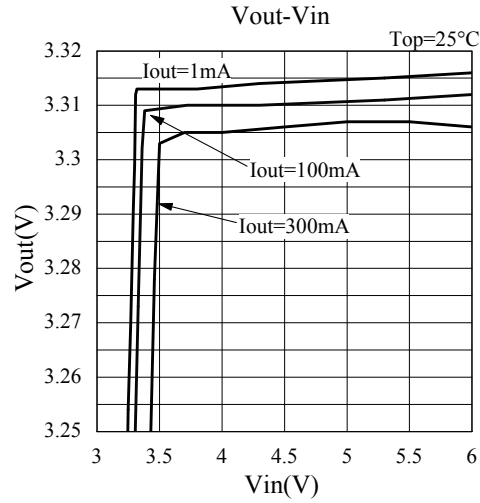
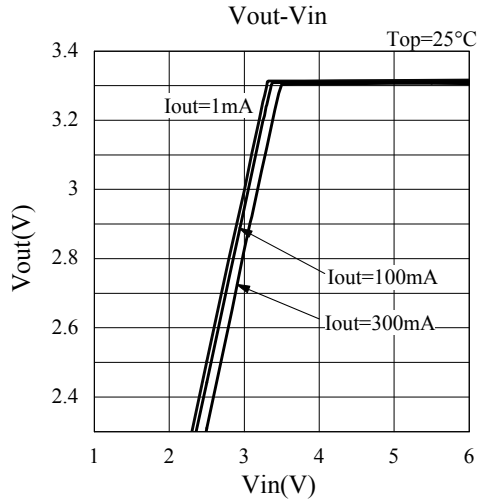

ELM85xxxxA CMOS 600mA/800mA LDO voltage regulator

<http://www.elm-tech.com>

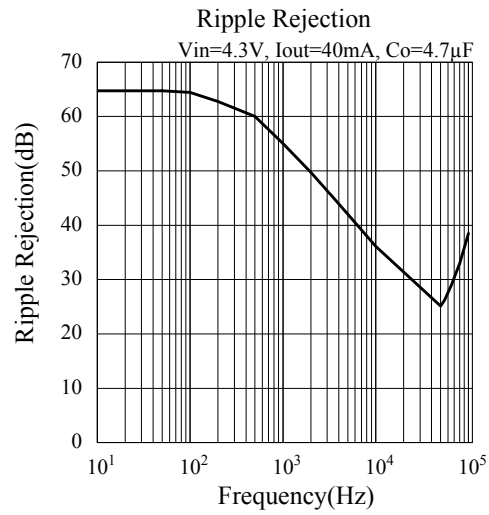
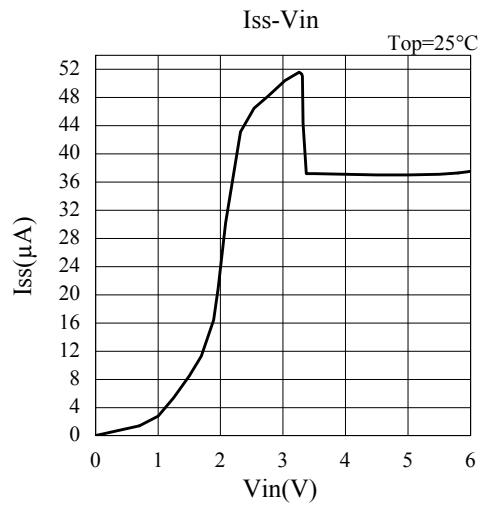
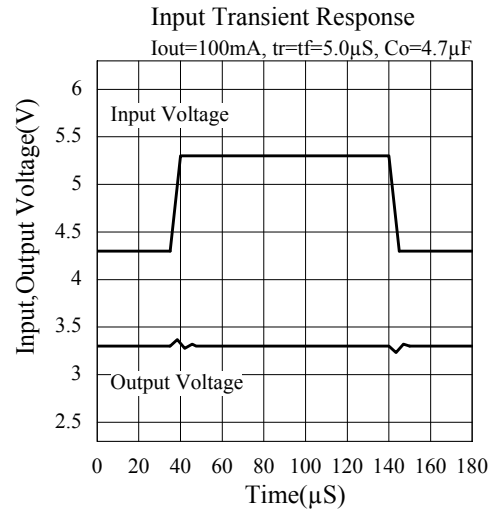
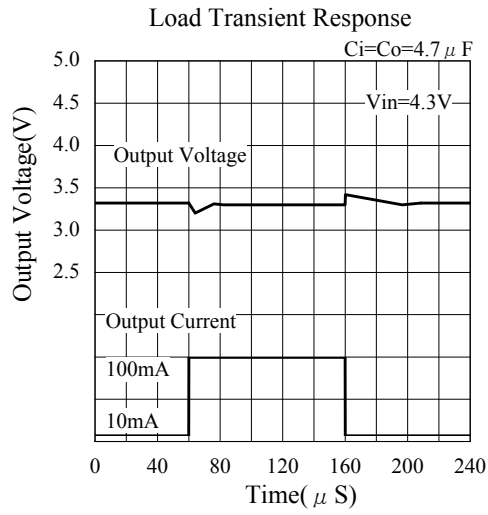

ELM85xxxxA CMOS 600mA/800mA LDO voltage regulator

<http://www.elm-tech.com>

- 5.0V Vout unit (ELM85501HA)

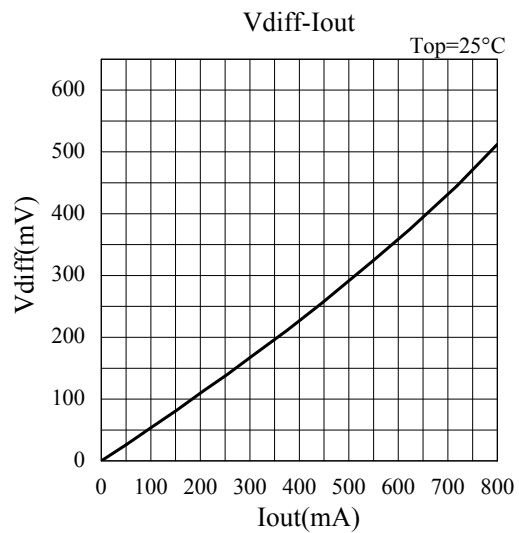
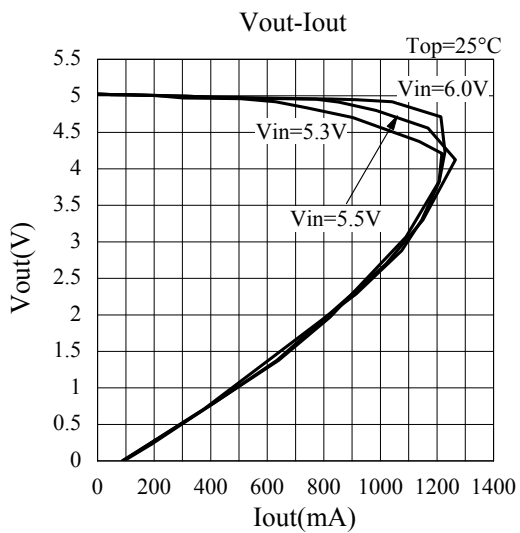
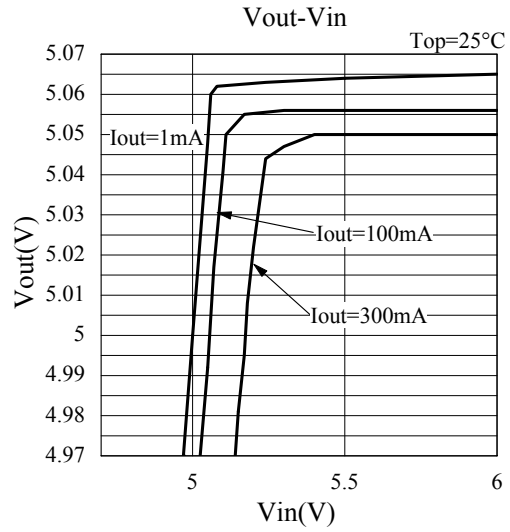
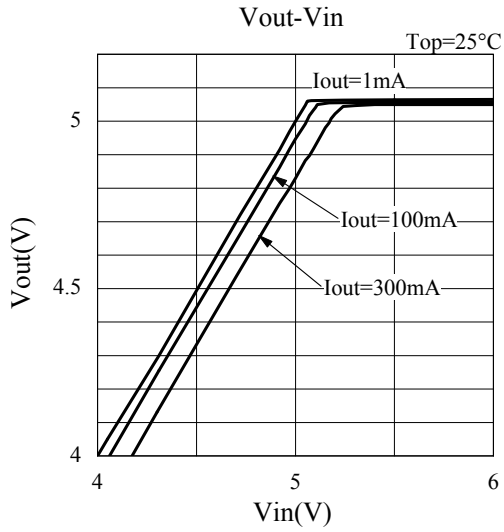

ELM85xxxxA CMOS 600mA/800mA LDO voltage regulator

<http://www.elm-tech.com>

