



SCHOTTKY BARRIER RECTIFIER

VOLTAGE RANGE 20 to 40 Volts CURRENT 0.5 Ampere

FEATURES

- * Low power loss, high efficiency
- * Low leakage
- * Low forward voltage
- * High current capability
- * High speed switching
- * High surge capability
- * High reliability

MECHANICAL DATA

- * Case: Molded plastic
- * Epoxy: Device has UL flammability classification 94V-0
- * Lead: MIL-STD-202E method 208C guaranteed
- * Mounting position: Any
- * Weight: 0.12 gram

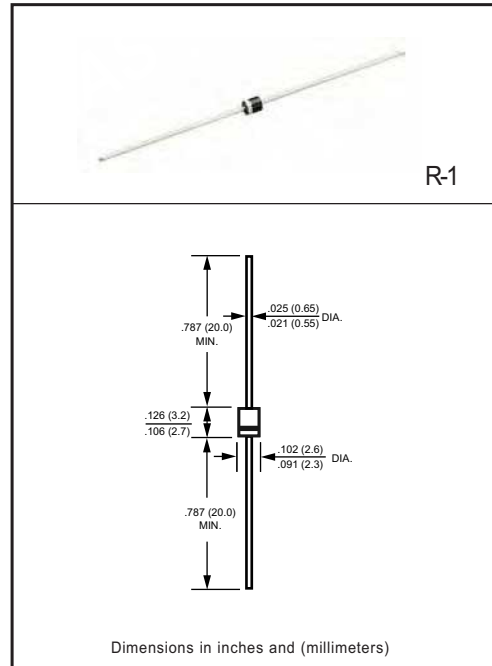

MAXIMUM RATINGS AND ELECTRICAL CHARACTERISTICS

Ratings at 25 °C ambient temperature unless otherwise specified.
Single phase, half wave, 60 Hz, resistive or inductive load.
For capacitive load, derate current by 20%.

MAXIMUM RATINGS (@ TA=25 °C unless otherwise noted)

RATINGS	SYMBOL	05S20	05S30	05S40	UNITS
Maximum Recurrent Peak Reverse Voltage	V _{RRM}	20	30	40	Volts
Maximum RMS Voltage	V _{RMS}	14	21	28	Volts
Maximum DC Blocking Voltage	V _{DC}	20	30	40	Volts
Maximum Average Forward Rectified Current .375" (9.5mm) lead length	I _O	0.5			Amps
Peak Forward Surge Current 8.3 ms single half sine-wave superimposed on rated load (JEDEC method)	I _{FSM}	60			Amps
Typical Thermal Resistance (Note 3)	R _{θJA}	60			°C/W
	R _{θJL}	20			
Typical Junction Capacitance (Note 1)	C _J	110			pF
Operating Temperature Range	T _J	150			°C
Storage Temperature Range	T _{STG}	-55 to + 150			°C

ELECTRICAL CHARACTERISTICS(@TA=25 °C unless otherwise noted)

CHARACTERISTICS	SYMBOL	05S20	05S30	05S40	UNITS
Maximum Instantaneous Forward Voltage at 0.5A DC	V _F	.30			Volts
Maximum Average Reverse Current at Rated DC Blocking Voltage	@T _A = 25°C	1.0			mAmps
	@T _A = 100°C	10			mAmps

- NOTES : 1. Measured at 1 MHz and applied reverse voltage of 4.0 volts.
2. "Fully ROHS compliant", "100% Sn plating (Pb-free)".
3. Thermal Resistance : At 9.5mm lead lengths, PCB mounted.

RATING AND CHARACTERISTICS CURVES (05S20 THRU 05S40)

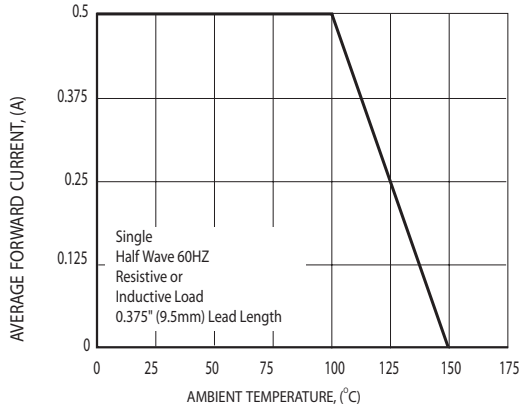

FIG.1 TYPICAL FORWARD CURRENT DERATING CURVE

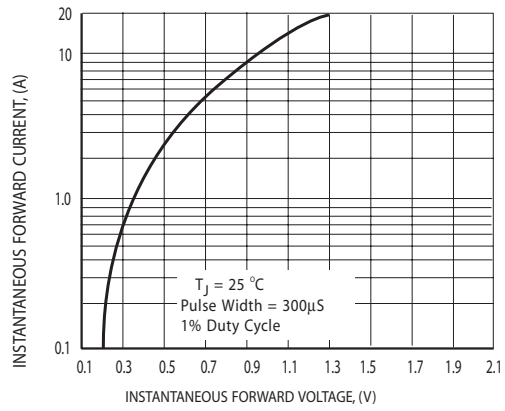

FIG.2 TYPICAL INSTANTANEOUS FORWARD CHARACTERISTICS

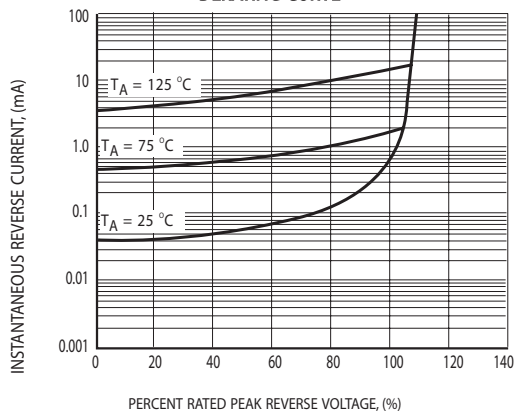

FIG.3 TYPICAL REVERSE CHARACTERISTICS

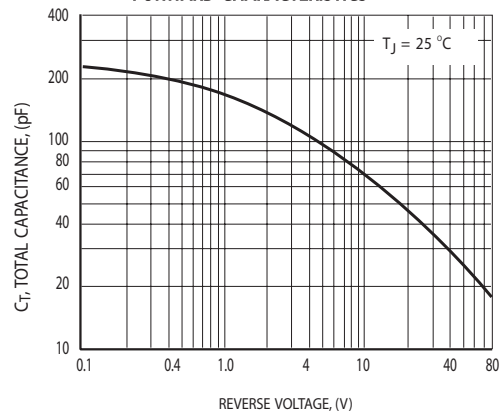

FIG.4 TYPICAL JUNCTION CAPACITANCE

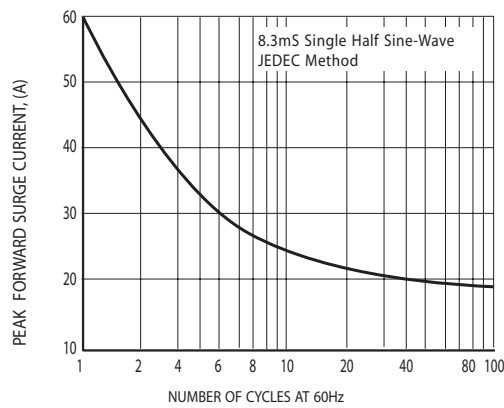

FIG.5 MAXIMUM NON-REPETITIVE FORWARD SURGE CURRENT



PACKAGING OF DIODE AND BRIDGE RECTIFIERS

BULK PACK

PACKAGE	PACKING CODE	EA PER BOX	INNER BOX SIZE (mm)	CARTON SIZE (mm)	EA PER CARTON	GROSS WEIGHT(Kg)
R-1	-B	1000 / 500	194*84*21	450*220*255	50,000 / 25,000	11.74 / 16.17

REEL PACK

PACKAGE	PACKING CODE	EA PER REEL	COMPONENT SPACE(mm)	TAPE SPACE (mm)	REEL DIA (mm)	CARTON SIZE (mm)	EA PER CARTON	GROSS WEIGHT(Kg)
R-1	-T	5,000	5.0	52	330	355*350*335	20,000	7.37

AMMO PACK

PACKAGE	PACKING CODE	REEL (EA)	COMPONENT SPACE(mm)	TAPE SPACE (mm)	BOX SIZE (mm)	CARTON SIZE(mm)	CARTON (EA)	GROSS WEIGHT (Kg)
R-1	-F	3,000	5.0	52	255*73*100	400*268*225	30,000	8.5
R-1	-E	3,000	5.0	26	256*48*94	365*270*217	42,000	8.35
R-1	-J	3,000	12.7	---	325*170*40	355*350*335	42,000	13.93
R-1	-I	2,000	12.7	---	325*170*40	355*350*335	28,000	9.69

1. BOX

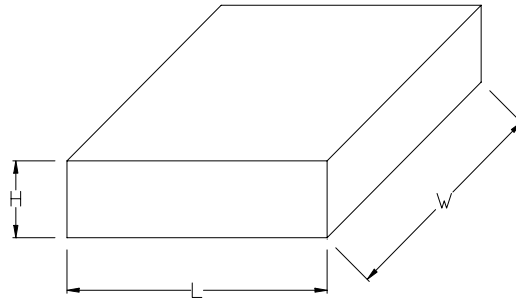

Packing Code	L (mm)	W (mm)	H (mm)
-F	255	73	100
-E	256	48	94
-J	325	170	40
-I	325	170	40

2. CARTON

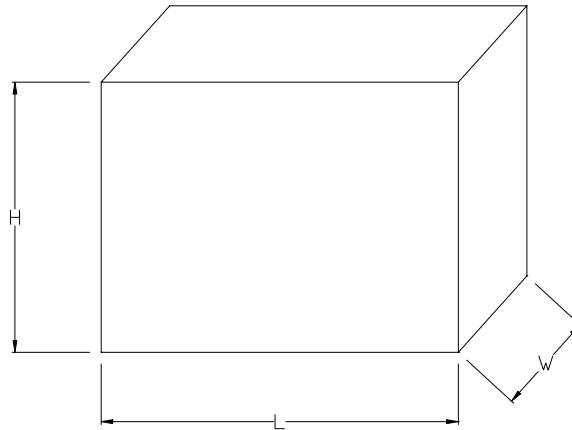

Packing Code	L (mm)	W (mm)	H (mm)
-T	355	350	335
-F	400	268	225
-E	365	270	217
-J	355	350	335
-I	355	350	335

Rectron Inc reserves the right to make changes without notice to any product specification herein, to make corrections, modifications, enhancements or other changes. Rectron Inc or anyone on its behalf assumes no responsibility or liability for any errors or inaccuracies. Data sheet specifications and its information contained are intended to provide a product description only. "Typical" parameters which may be included on RECTRON data sheets and/ or specifications can and do vary in different applications and actual performance may vary over time. Rectron Inc does not assume any liability arising out of the application or use of any product or circuit.

Rectron products are not designed, intended or authorized for use in medical, life-saving implant or other applications intended for life-sustaining or other related applications where a failure or malfunction of component or circuitry may di-