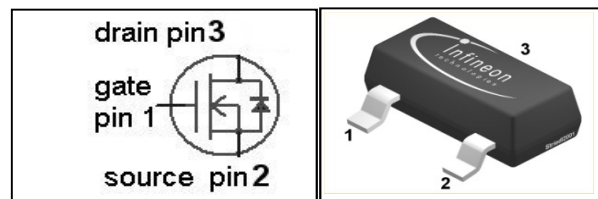

**SIPMOS® Small-Signal-Transistor**
**Features**

- N-channel
- Depletion mode
- $dv/dt$  rated
- Available with  $V_{GS(th)}$  indicator on reel
- Pb-free lead-plating; RoHS compliant
- Halogen-free according to AEC61249-2-21
- Qualified according to AEC Q101

**Product Summary**

$V_{DS}$	100	V
$R_{DS(on),max}$	12	$\Omega$
$I_{DSS,min}$	0.09	A

**PG-SOT-23**

Type	Package	Pb-free	Tape and Reel Information	Marking
BSS169	PG-SOT-23	Yes	H6327: 3000 pcs/reel	SFs
BSS169	PG-SOT-23	Yes	H6906: 3000 pcs/reel sorted in $V_{GS(th)}$ bands <sup>1)</sup>	SFs

**Maximum ratings, at  $T_j=25\text{ °C}$ , unless otherwise specified**

Parameter	Symbol	Conditions	Value	Unit
Continuous drain current	$I_D$	$T_A=25\text{ °C}$	0.17	A
		$T_A=70\text{ °C}$	0.14	
Pulsed drain current	$I_{D,pulse}$	$T_A=25\text{ °C}$	0.68	
Reverse diode $dv/dt$	$dv/dt$	$I_D=0.17\text{ A}$ , $V_{DS}=80\text{ V}$ , $di/dt=200\text{ A}/\mu\text{s}$ , $T_{j,max}=150\text{ °C}$	6	kV/ $\mu\text{s}$
Gate source voltage	$V_{GS}$		$\pm 20$	V
ESD Class		JESD22-A114-HBM	Class 0	
Power dissipation	$P_{tot}$	$T_A=25\text{ °C}$	0.36	W
Operating and storage temperature	$T_j, T_{stg}$		-55 ... 150	$^{\circ}\text{C}$
IEC climatic category; DIN IEC 68-1			55/150/56	

<sup>1)</sup> see table on next page and diagram 11

Parameter	Symbol	Conditions	Values			Unit
			min.	typ.	max.	

**Thermal characteristics**

Thermal resistance, junction - ambient	$R_{thJA}$	minimal footprint	-	-	350	K/W
--	------------	-------------------	---	---	-----	-----

**Electrical characteristics, at  $T_j=25\text{ }^\circ\text{C}$ , unless otherwise specified**
**Static characteristics**

Drain-source breakdown voltage	$V_{(BR)DSS}$	$V_{GS}=-10\text{ V}, I_D=250\text{ }\mu\text{A}$	100	-	-	V
Gate threshold voltage	$V_{GS(th)}$	$V_{DS}=3\text{ V}, I_D=50\text{ }\mu\text{A}$	-2.9	-2.2	-1.8	
Drain-source cutoff current	$I_{D(off)}$	$V_{DS}=100\text{ V},$ $V_{GS}=-10\text{ V}, T_j=25\text{ }^\circ\text{C}$	-	-	0.1	$\mu\text{A}$
		$V_{DS}=100\text{ V},$ $V_{GS}=-10\text{ V}, T_j=125\text{ }^\circ\text{C}$	-	-	10	
Gate-source leakage current	$I_{GSS}$	$V_{GS}=20\text{ V}, V_{DS}=0\text{ V}$	-	-	10	nA
On-state drain current	$I_{DSS}$	$V_{GS}=0\text{ V}, V_{DS}=10\text{ V}$	90	-	-	mA
Drain-source on-state resistance	$R_{DS(on)}$	$V_{GS}=0\text{ V}, I_D=0.05\text{ A}$	-	5.3	12	$\Omega$
		$V_{GS}=10\text{ V}, I_D=0.17\text{ A}$	-	2.9	6	
Transconductance	$g_{fs}$	$ V_{DS} >2 I_D R_{DS(on)max},$ $I_D=0.14\text{ A}$	0.10	0.19	-	S

**Threshold voltage  $V_{GS(th)}$  sorted in bands<sup>2)</sup>**

J	$V_{GS(th)}$	$V_{DS}=3\text{ V}, I_D=50\text{ }\mu\text{A}$	-2	-	-1.8	V
K			-2.15	-	-1.95	
L			-2.3	-	-2.1	
M			-2.45	-	-2.25	
N			-2.6	-	-2.4	

<sup>2)</sup> Each reel contains transistors out of one band whose identifying letter is printed on the reel label. A specific band cannot be ordered separately.

Parameter	Symbol	Conditions	Values			Unit
			min.	typ.	max.	

**Dynamic characteristics**

Input capacitance	$C_{iss}$	$V_{GS}=-10\text{ V}, V_{DS}=25\text{ V},$ $f=1\text{ MHz}$	-	51	68	pF
Output capacitance	$C_{oss}$		-	9	13	
Reverse transfer capacitance	$C_{rss}$		-	4	7	
Turn-on delay time	$t_{d(on)}$	$V_{DD}=50\text{ V},$ $V_{GS}=-3\dots 7\text{ V},$ $I_D=0.12\text{ A}, R_G=6\ \Omega$	-	2.9	4.2	ns
Rise time	$t_r$		-	2.7	4.0	
Turn-off delay time	$t_{d(off)}$		-	11	17	
Fall time	$t_f$		-	27	40	

**Gate Charge Characteristics**

Gate to source charge	$Q_{gs}$	$V_{DD}=80\text{ V}, I_D=0.12\text{ A},$ $V_{GS}=-3\text{ to }7\text{ V}$	-	0.12	0.16	nC
Gate to drain charge	$Q_{gd}$		-	0.9	1.4	
Gate charge total	$Q_g$		-	2.1	2.8	
Gate plateau voltage	$V_{plateau}$		-	-0.43	-	V

**Reverse Diode**

Diode continuous forward current	$I_S$	$T_A=25\text{ }^\circ\text{C}$	-	-	0.17	A
Diode pulse current	$I_{S,pulse}$		-	-	0.68	
Diode forward voltage	$V_{SD}$	$V_{GS}=-10\text{ V}, I_F=0.17\text{ A},$ $T_J=25\text{ }^\circ\text{C}$	-	0.79	1.2	V
Reverse recovery time	$t_{rr}$	$V_R=50\text{ V}, I_F=0.12\text{ A},$ $di_F/dt=100\text{ A}/\mu\text{s}$	-	20.5	25.6	ns
Reverse recovery charge	$Q_{rr}$		-	9.7	12.1	nC

**1 Power dissipation**

$P_{tot}=f(T_A)$

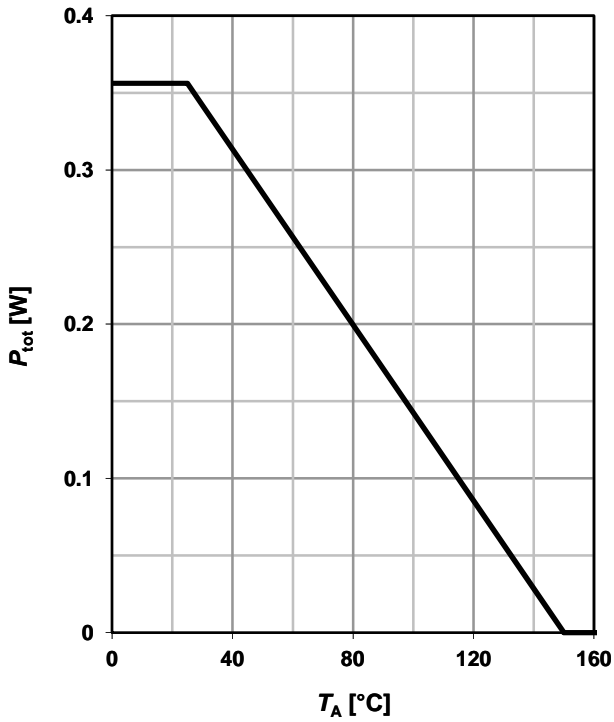

**2 Drain current**

$I_D=f(T_A); V_{GS} \geq 10\text{ V}$

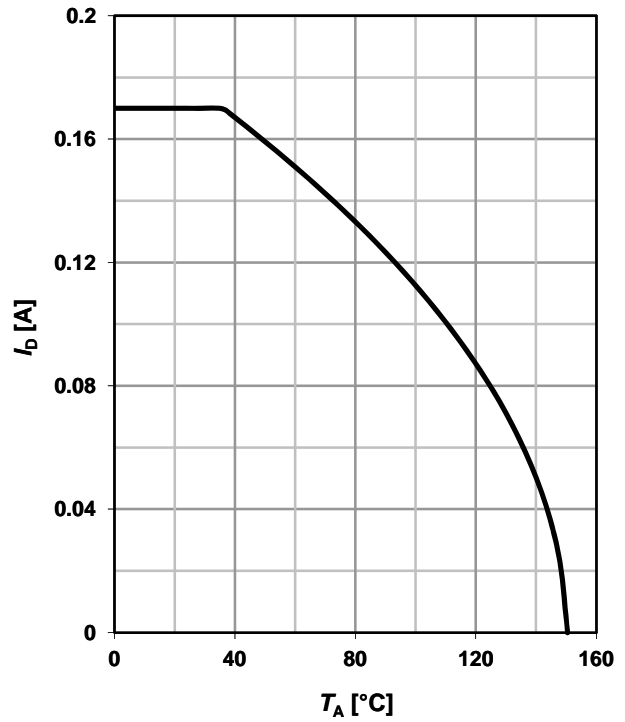

**3 Safe operating area**

$I_D=f(V_{DS}); T_A=25\text{ °C}; D=0$

parameter:  $t_p$

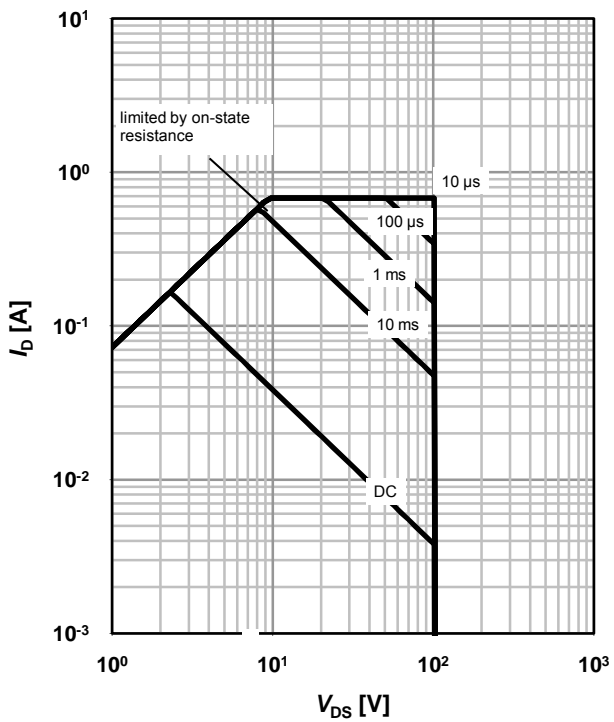

**4 Max. transient thermal impedance**

$Z_{thJA}=f(t_p)$

parameter:  $D=t_p/T$

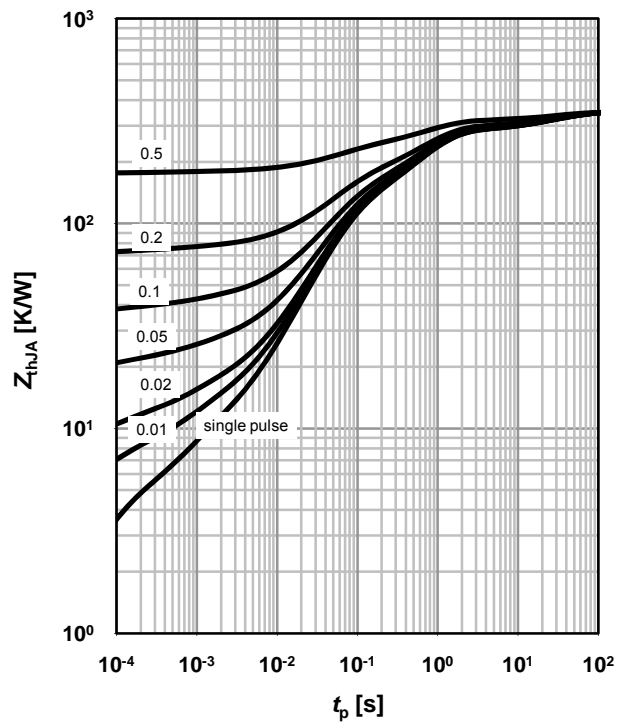

**5 Typ. output characteristics**

$I_D = f(V_{DS}); T_j = 25\text{ }^\circ\text{C}$

parameter:  $V_{GS}$

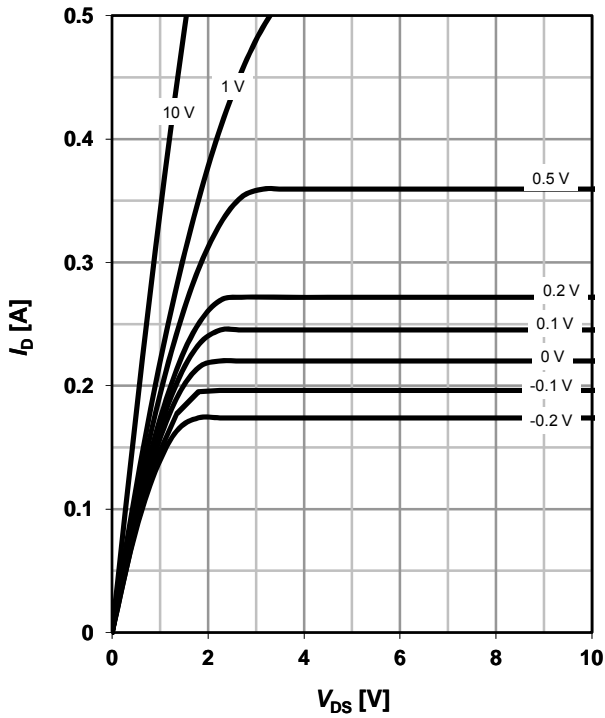

**6 Typ. drain-source on resistance**

$R_{DS(on)} = f(I_D); T_j = 25\text{ }^\circ\text{C}$

parameter:  $V_{GS}$

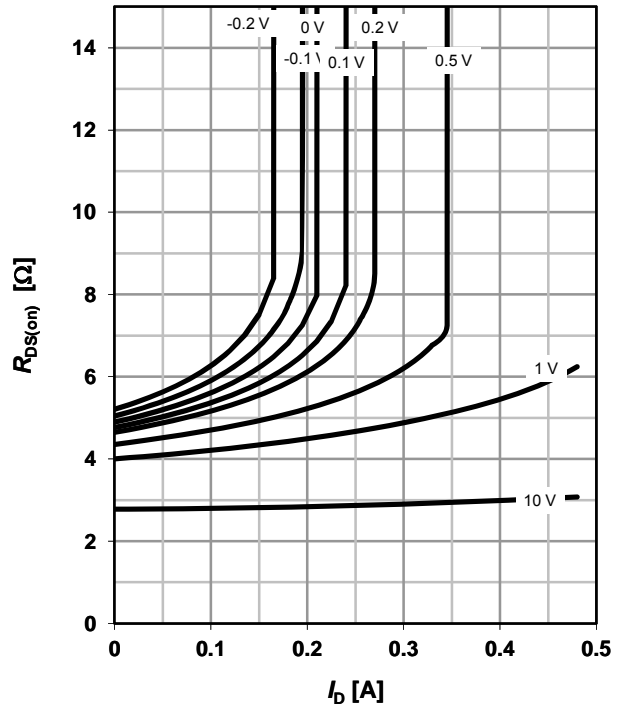

**7 Typ. transfer characteristics**

$I_D = f(V_{GS}); |V_{DS}| > 2|I_D|R_{DS(on)max}$

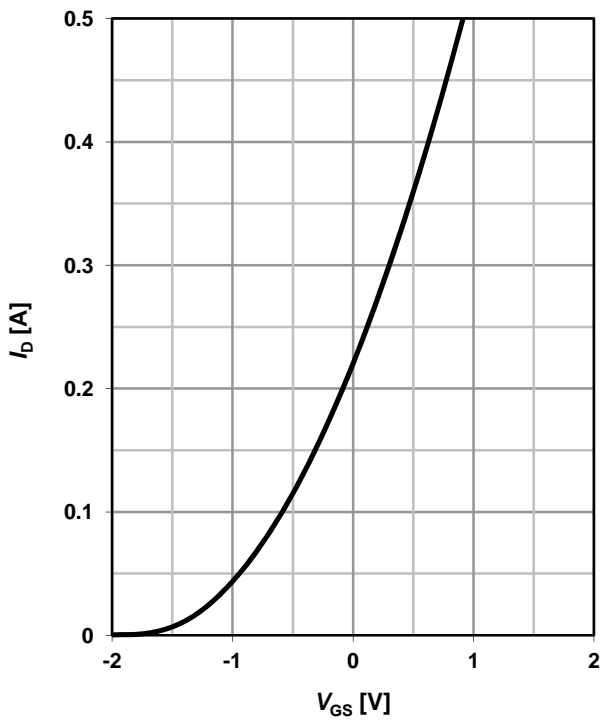

**8 Typ. forward transconductance**

$g_{fs} = f(I_D); T_j = 25\text{ }^\circ\text{C}$

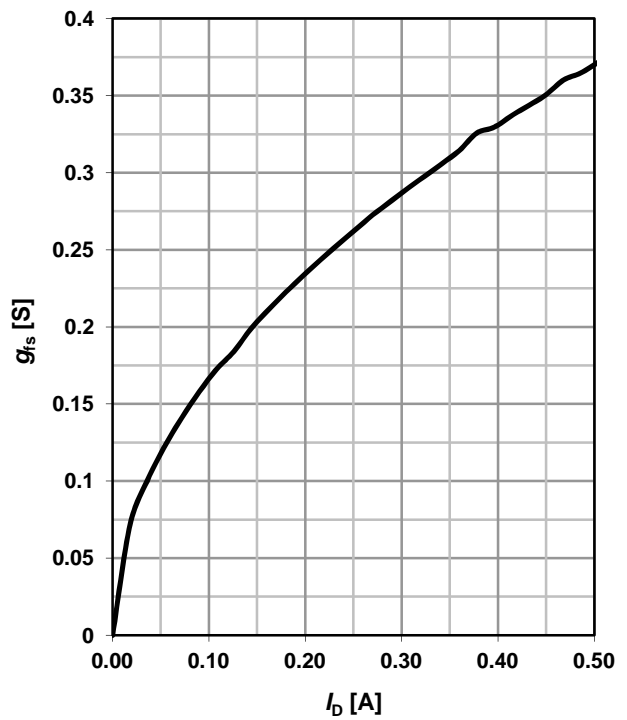

**9 Drain-source on-state resistance**

$R_{DS(on)}=f(T_j); I_D=0.05\text{ A}; V_{GS}=0\text{ V}$

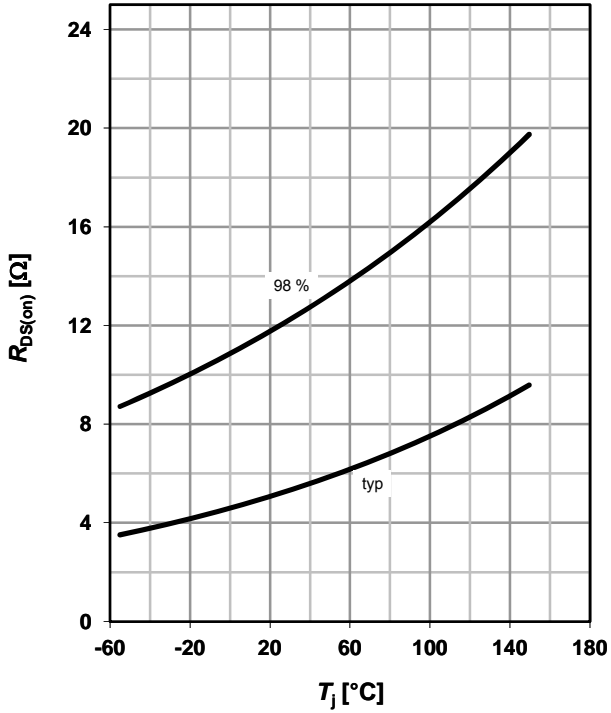

**10 Typ. gate threshold voltage**

$V_{GS(th)}=f(T_j); V_{DS}=3\text{ V}; I_D=50\text{ }\mu\text{A}$

parameter:  $I_D$

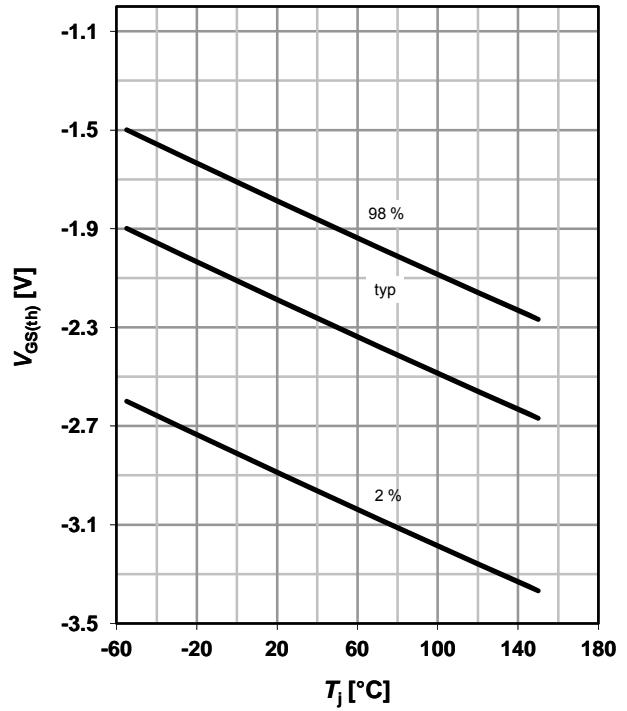

**11 Threshold voltage bands**

$I_D=f(V_{GS}); V_{DS}=3\text{ V}; T_j=25\text{ }^\circ\text{C}$

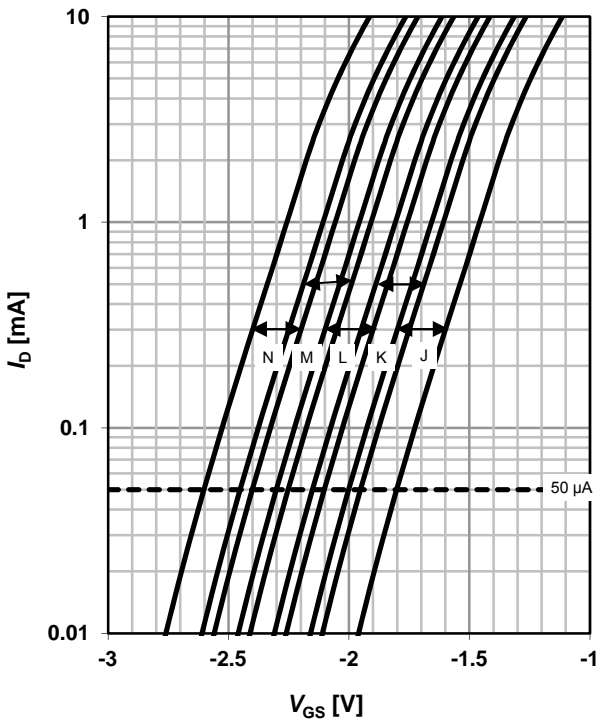

**12 Typ. capacitances**

$C=f(V_{DS}); V_{GS}=-10\text{ V}; f=1\text{ MHz}$

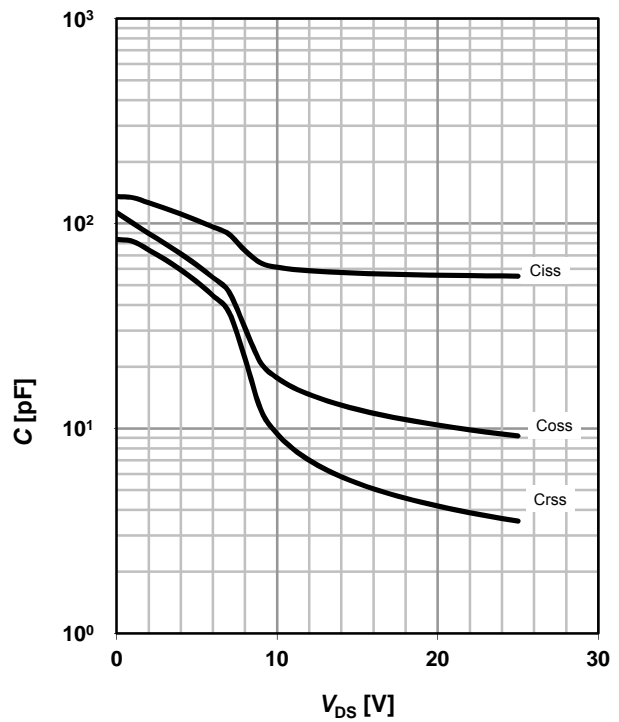

**13 Forward characteristics of reverse diode**

$I_F = f(V_{SD})$

parameter:  $T_j$

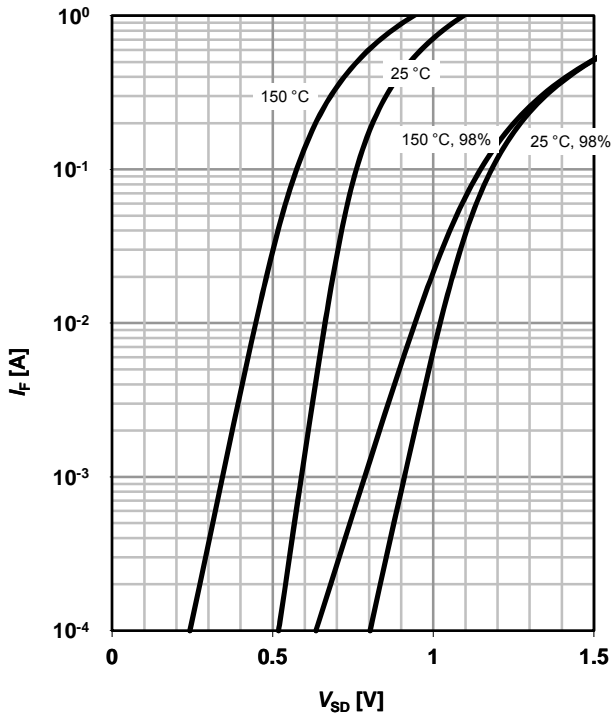

**15 Typ. gate charge**

$V_{GS} = f(Q_{gate}); I_D = 0.12 \text{ A pulsed}$

parameter:  $V_{DD}$

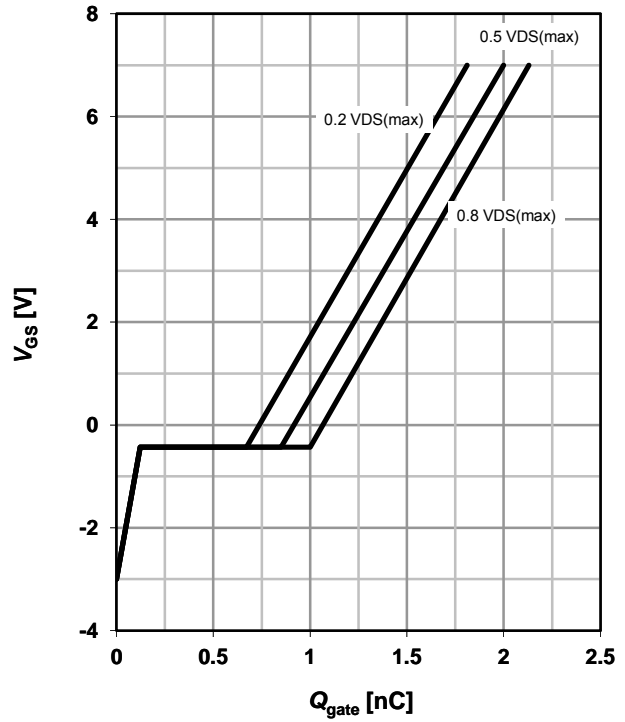

**16 Drain-source breakdown voltage**

$V_{BR(DSS)} = f(T_j); I_D = 250 \mu\text{A}$

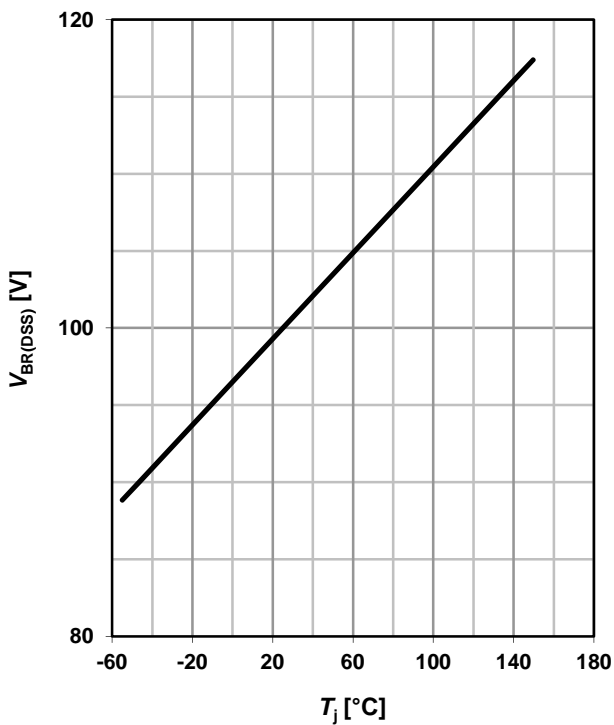

Package Outline:

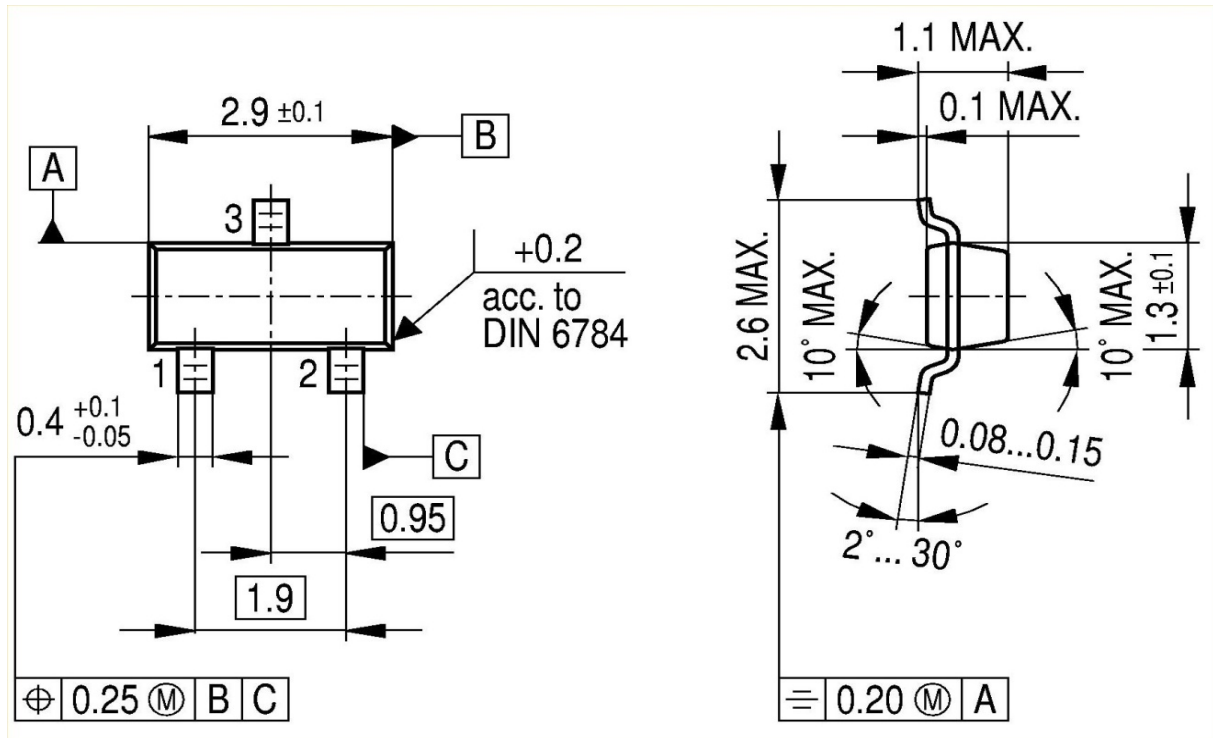

Footprint:

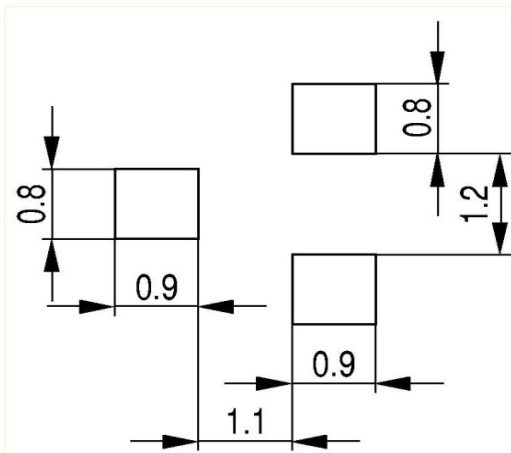

Packaging:

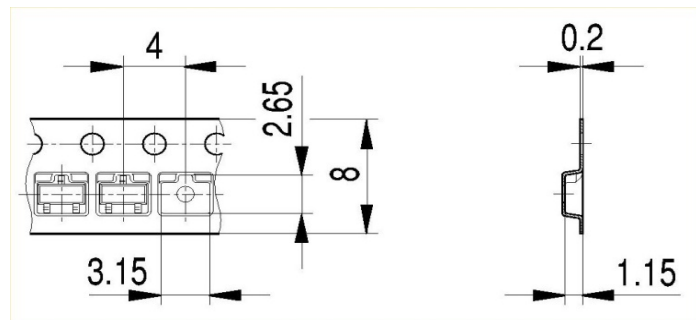

Dimensions in mm



**Published by**  
**Infineon Technologies AG**  
**81726 Munich, Germany**  
**© 2010 Infineon Technologies AG**  
**All Rights Reserved.**

**Legal Disclaimer**

The information given in this document shall in no event be regarded as a guarantee of conditions or characteristics. With respect to any examples or hints given herein, any typical values stated herein and/or any information regarding the application of the device, Infineon Technologies hereby disclaims any and all warranties and liabilities of any kind, including without limitation, warranties of non-infringement of intellectual property rights of any third party.

**Information**

For further information on technology, delivery terms and conditions and prices, please contact the nearest Infineon Technologies Office ([www.infineon.com](http://www.infineon.com)).

**Warnings**

Due to technical requirements, components may contain dangerous substances. For information on the types in question, please contact the nearest Infineon Technologies Office. Infineon Technologies components may be used in life-support devices or systems only with the express written approval of Infineon Technologies, if a failure of such components can reasonably be expected to cause the failure of that life-support device or system or to affect the safety or effectiveness of that device or system. Life support devices or systems are intended to be implanted in the human body or to support and/or maintain and sustain and/or protect human life. If they fail, it is reasonable to assume that the health of the user or other persons may be endangered.