

HEXFET® Power MOSFET

Features

- Advanced Process Technology
- Ultra Low On-Resistance
- 175°C Operating Temperature
- Fast Switching
- Repetitive Avalanche Allowed up to Tjmax
- Lead-Free, RoHS Compliant
- Automotive Qualified *

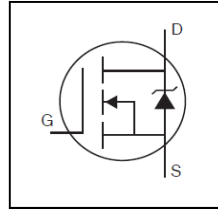

V_{DSS}	40V
R_{DS(on)} typ.	0.90mΩ
	max.
I_D (Silicon Limited)	400A^①
I_D (Package Limited)	240A

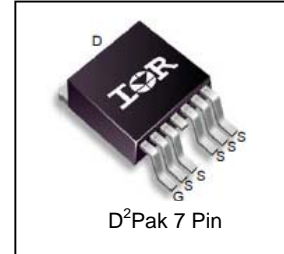

Description

Specifically designed for Automotive applications, this HEXFET® Power MOSFET utilizes the latest processing techniques to achieve extremely low on-resistance per silicon area. Additional features of this design are a 175°C junction operating temperature, fast switching speed and improved repetitive avalanche rating. These features combine to make this design an extremely efficient and reliable device for use in Automotive applications and wide variety of other applications.

G	D	S
Gate	Drain	Source

Base Part Number	Package Type	Standard Pack		Orderable Part Number
		Form	Quantity	
AUIRFS3004-7P	D²Pak 7 Pin	Tube	50	AUIRFS3004-7P
		Tape and Reel Left	800	AUIRFS3004-7PTRL

Absolute Maximum Ratings

Stresses beyond those listed under “Absolute Maximum Ratings” may cause permanent damage to the device. These are stress ratings only; and functional operation of the device at these or any other condition beyond those indicated in the specifications is not implied. Exposure to absolute-maximum-rated conditions for extended periods may affect device reliability. The thermal resistance and power dissipation ratings are measured under board mounted and still air conditions. Ambient temperature (TA) is 25°C, unless otherwise specified.

Symbol	Parameter	Max.	Units
I _D @ T _C = 25°C	Continuous Drain Current, V _{GS} @ 10V (Silicon Limited)	400 ^①	A
I _D @ T _C = 100°C	Continuous Drain Current, V _{GS} @ 10V (Silicon Limited)	280 ^①	
I _D @ T _C = 25°C	Continuous Drain Current, V _{GS} @ 10V (Wire Bond Limited)	240	
I _{DM}	Pulsed Drain Current ^②	1610	
P _D @ T _C = 25°C	Maximum Power Dissipation	380	W
	Linear Derating Factor	2.5	W/°C
V _{GS}	Gate-to-Source Voltage	± 20	V
E _{AS}	Single Pulse Avalanche Energy (Thermally Limited) ^③	290	mJ
I _{AR}	Avalanche Current ^②	See Fig.14,15, 22a, 22b	A
E _{AR}	Repetitive Avalanche Energy ^②		mJ
dv/dt	Peak Diode Recovery ^④	2.0	V/ns
T _J	Operating Junction and	-55 to + 175	°C
T _{STG}	Storage Temperature Range		
	Soldering Temperature, for 10 seconds (1.6mm from case)	300	

Thermal Resistance

Symbol	Parameter	Typ.	Max.	Units
R _{θJC}	Junction-to-Case ^⑨ ^⑩	—	0.40	°C/W
R _{θJA}	Junction-to-Ambient (PCB Mount) ^⑧	—	40	

HEXFET® is a registered trademark of Infineon.

*Qualification standards can be found at www.infineon.com

Static @ T_J = 25°C (unless otherwise specified)

	Parameter	Min.	Typ.	Max.	Units	Conditions
V _{(BR)DSS}	Drain-to-Source Breakdown Voltage	40	—	—	V	V _{GS} = 0V, I _D = 250μA
ΔV _{(BR)DSS} /ΔT _J	Breakdown Voltage Temp. Coefficient	—	0.038	—	V/°C	Reference to 25°C, I _D = 5mA ②
R _{DS(on)}	Static Drain-to-Source On-Resistance	—	0.90	1.25	mΩ	V _{GS} = 10V, I _D = 195A ⑤
V _{GS(th)}	Gate Threshold Voltage	2.0	—	4.0	V	V _{DS} = V _{GS} , I _D = 250μA
g _{fs}	Forward Trans conductance	1300	—	—	S	V _{DS} = 10V, I _D = 195A
R _G	Gate Resistance	—	2.0	—	Ω	
I _{DSS}	Drain-to-Source Leakage Current	—	—	20	μA	V _{DS} = 40V, V _{GS} = 0V
		—	—	250		V _{DS} = 40V, V _{GS} = 0V, T _J = 125°C
I _{GSS}	Gate-to-Source Forward Leakage	—	—	100	nA	V _{GS} = 20V
	Gate-to-Source Reverse Leakage	—	—	-100		V _{GS} = -20V

Dynamic Electrical Characteristics @ T_J = 25°C (unless otherwise specified)

Q _g	Total Gate Charge	—	160	240	nC	I _D = 180A V _{DS} = 20V V _{GS} = 10V ⑤
Q _{gs}	Gate-to-Source Charge	—	42	—		
Q _{gd}	Gate-to-Drain Charge	—	65	—		
Q _{sync}	Total Gate Charge Sync. (Q _g - Q _{gd})	—	95	—		
t _{d(on)}	Turn-On Delay Time	—	23	—	ns	V _{DD} = 26V I _D = 240A R _G = 2.7Ω V _{GS} = 10V ⑤
t _r	Rise Time	—	240	—		
t _{d(off)}	Turn-Off Delay Time	—	91	—		
t _f	Fall Time	—	160	—		
C _{iss}	Input Capacitance	—	9130	—	pF	V _{GS} = 0V V _{DS} = 25V f = 1.0MHz, See Fig. 5
C _{oss}	Output Capacitance	—	2020	—		
C _{riss}	Reverse Transfer Capacitance	—	990	—		
C _{oss eff.(ER)}	Effective Output Capacitance (Energy Related)	—	2590	—		
C _{oss eff.(TR)}	Effective Output Capacitance (Time Related)	—	2650	—		

Diode Characteristics

	Parameter	Min.	Typ.	Max.	Units	Conditions
I _S	Continuous Source Current (Body Diode)	—	—	400 ①	A	MOSFET symbol showing the integral reverse p-n junction diode.
I _{SM}	Pulsed Source Current (Body Diode) ②	—	—	1610		
V _{SD}	Diode Forward Voltage	—	—	1.3	V	T _J = 25°C, I _S = 195A, V _{GS} = 0V ⑤
t _{rr}	Reverse Recovery Time	—	49	—	ns	T _J = 25°C V _{DD} = 34V
		—	51	—		T _J = 125°C I _F = 240A,
Q _{rr}	Reverse Recovery Charge	—	37	—	nC	T _J = 25°C di/dt = 100A/μs ⑤
		—	41	—		T _J = 125°C
I _{RRM}	Reverse Recovery Current	—	3.2	—	A	T _J = 25°C
t _{on}	Forward Turn-On Time	Intrinsic turn-on time is negligible (turn-on is dominated by L _S +L _D)				

Notes:

- ① Calculated continuous current based on maximum allowable junction temperature. Bond wire current limit is 240A. Note that current limitations arising from heating of the device leads may occur with some lead mounting arrangements.
- ② Repetitive rating; pulse width limited by max. junction temperature.
- ③ Limited by T_{Jmax}, starting T_J = 25°C, L = 0.01mH, R_G = 25Ω, I_{AS} = 240A, V_{GS} = 10V. Part not recommended for use above this value.
- ④ I_{SD} ≤ 240A, di/dt ≤ 740A/μs, V_{DD} ≤ V_{(BR)DSS}, T_J ≤ 175°C.
- ⑤ Pulse width ≤ 400μs; duty cycle ≤ 2%.
- ⑥ C_{oss eff. (TR)} is a fixed capacitance that gives the same charging time as C_{oss} while V_{DS} is rising from 0 to 80% V_{DSS}.
- ⑦ C_{oss eff. (ER)} is a fixed capacitance that gives the same energy as C_{oss} while V_{DS} is rising from 0 to 80% V_{DSS}.
- ⑧ When mounted on 1" square PCB (FR-4 or G-10 Material). For recommended footprint and soldering techniques refer to application note #AN-994
- ⑨ R_θ is measured at T_J approximately 90°C.
- ⑩ R_{θJC} value shown is at time zero

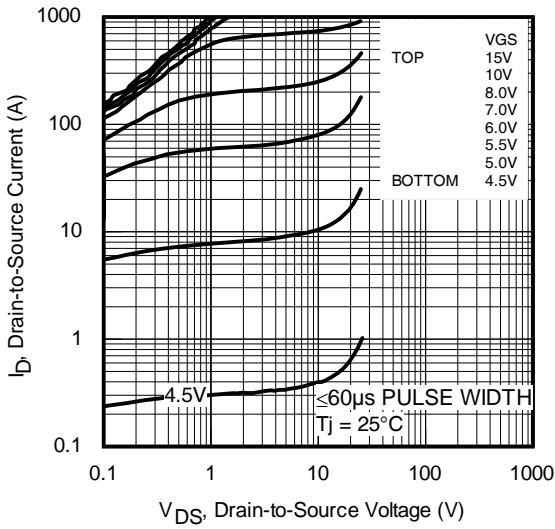
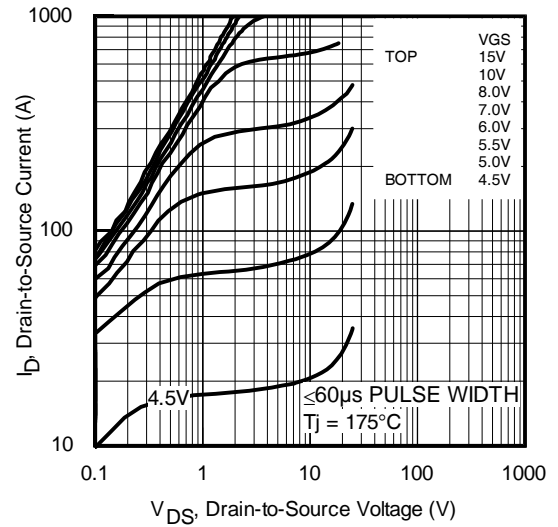
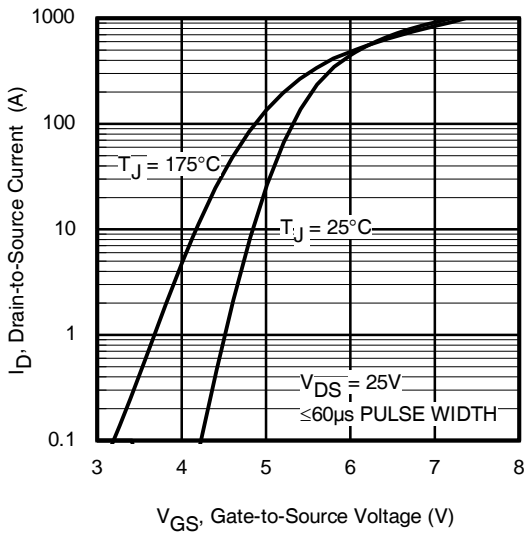
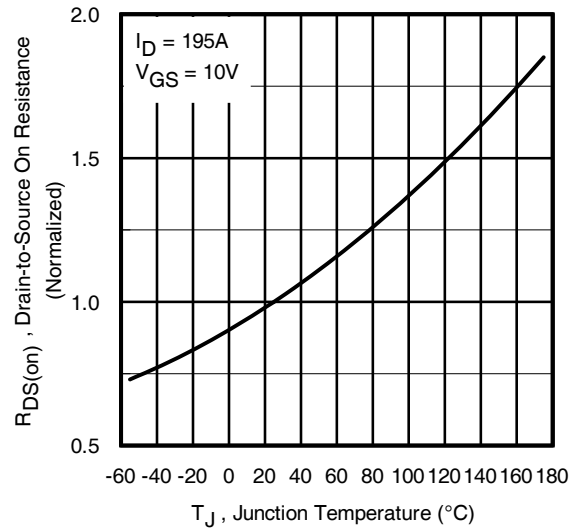
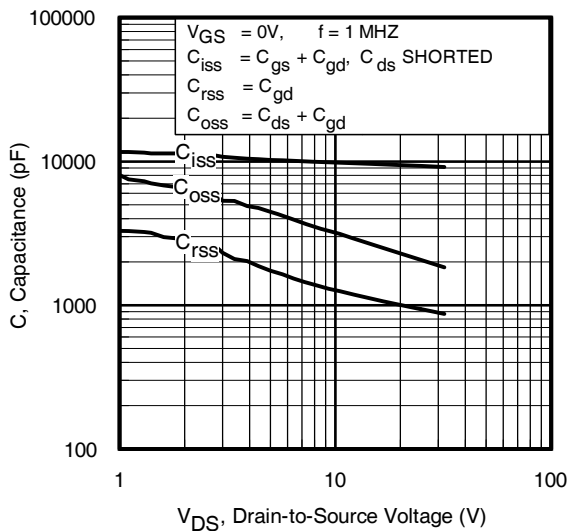
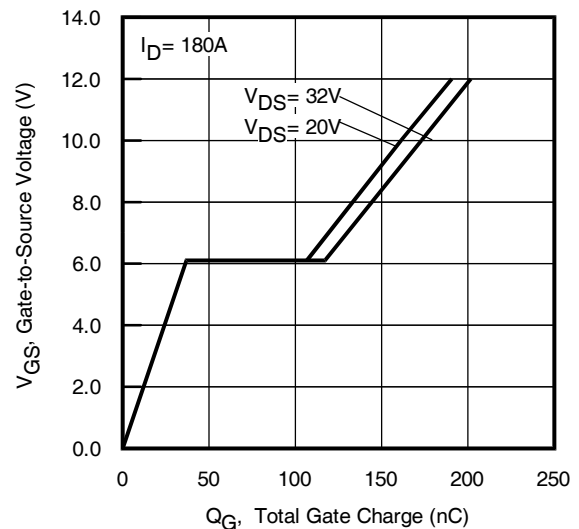
Fig. 1 Typical Output Characteristics

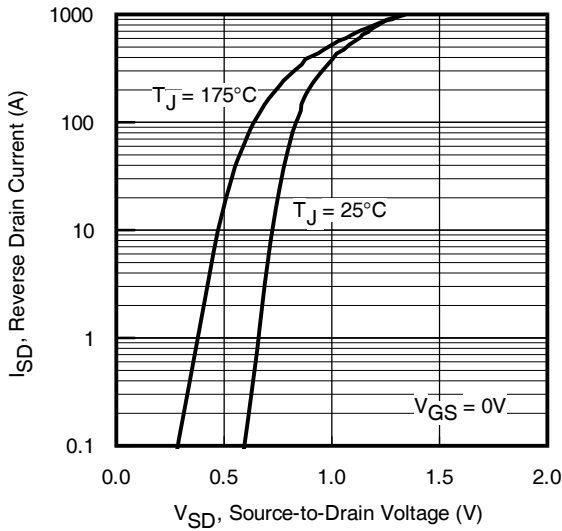
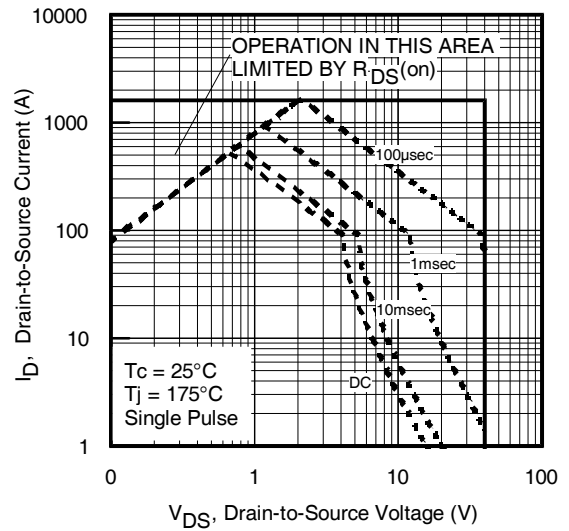
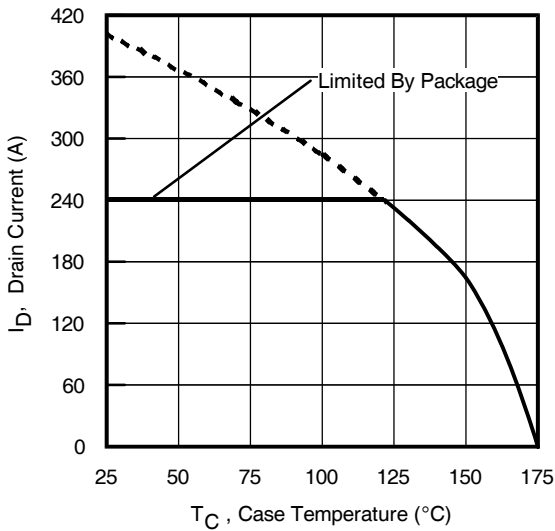
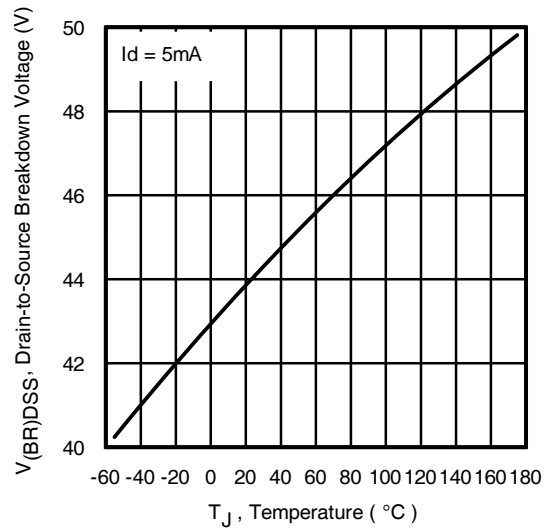
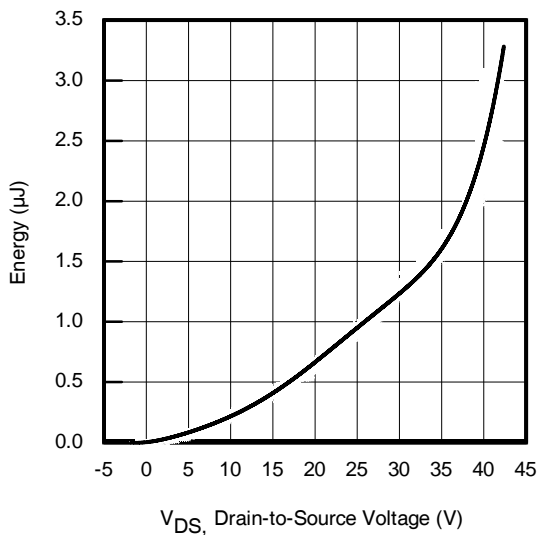
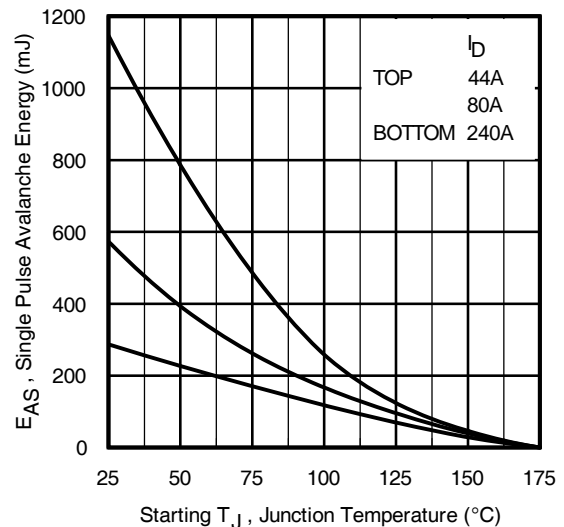
Fig. 2 Typical Output Characteristics

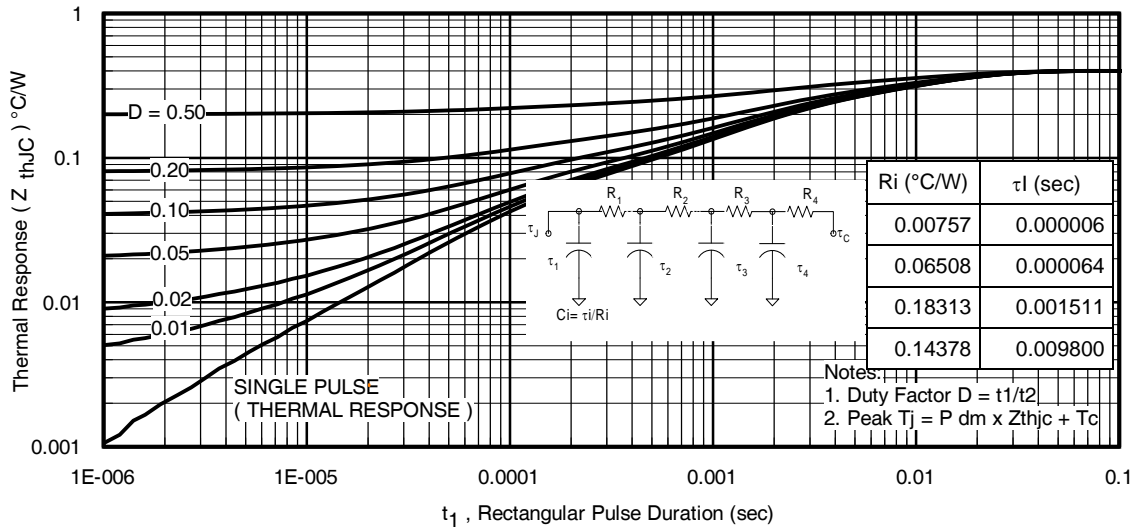
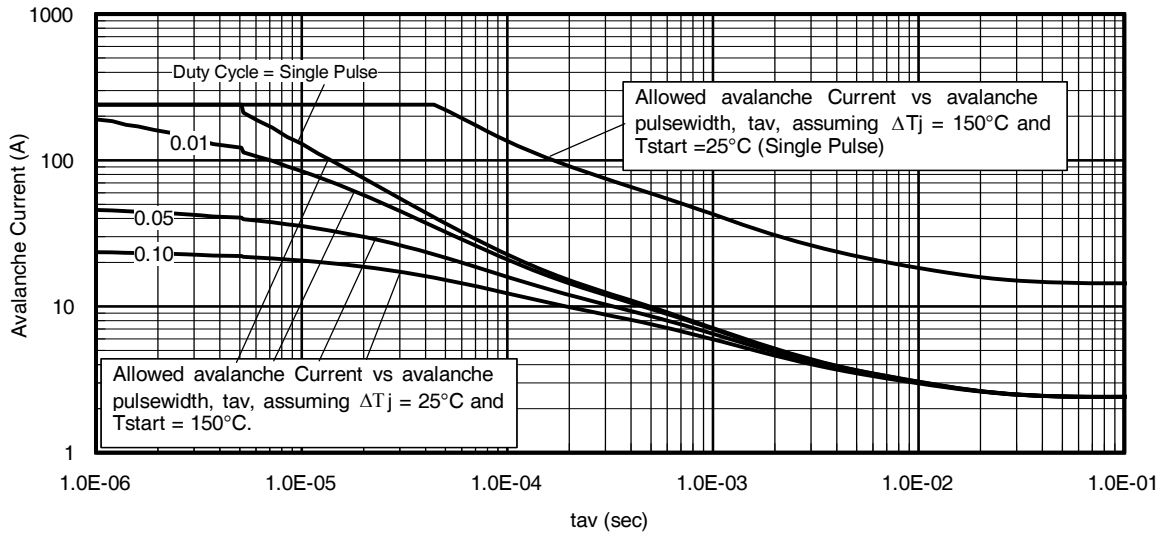
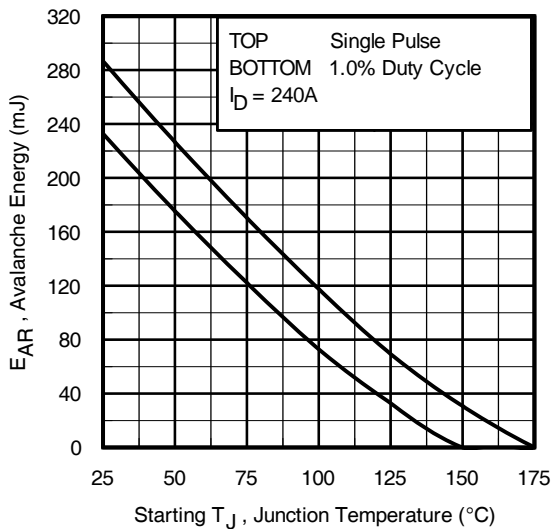
Fig. 3 Typical Transfer Characteristics

Fig. 4 Normalized On-Resistance vs. Temperature

Fig. 5. Typical Capacitance vs. Drain-to-Source Voltage

Fig. 6. Typical Gate Charge vs. Gate-to-Source Voltage

Fig. 7 Typical Source-to-Drain Diode Forward Voltage

Fig. 8. Maximum Safe Operating Area

Fig 9. Maximum Drain Current vs. Case Temperature

Fig 10. Drain-to-Source Breakdown Voltage

Fig 11. Typical Coss Stored Energy

Fig 12. Maximum Avalanche Energy vs. Drain Current

Fig 13. Maximum Effective Transient Thermal Impedance, Junction-to-Case

Fig 14. Avalanche Current vs. Pulse width

**Notes on Repetitive Avalanche Curves , Figures 14, 15:
 (For further info, see AN-1005 at www.infineon.com)**

1. Avalanche failures assumption:
Purely a thermal phenomenon and failure occurs at a temperature far in excess of T_{jmax} . This is validated for every part type.
2. Safe operation in Avalanche is allowed as long as T_{jmax} is not exceeded.
3. Equation below based on circuit and waveforms shown in Figures 18a, 18b.
4. $P_{D(ave)}$ = Average power dissipation per single avalanche pulse.
5. BV = Rated breakdown voltage (1.3 factor accounts for voltage increase during avalanche).
6. I_{av} = Allowable avalanche current.
7. ΔT = Allowable rise in junction temperature, not to exceed T_{jmax} (assumed as 25°C in Figure 13, 14).
 t_{av} = Average time in avalanche.
 D = Duty cycle in avalanche = $t_{av} \cdot f$
 $Z_{thJC}(D, t_{av})$ = Transient thermal resistance, see Figures 13)

$$P_{D(ave)} = 1/2 (1.3 \cdot BV \cdot I_{av}) = \Delta T / Z_{thJC}$$

$$I_{av} = 2\Delta T / [1.3 \cdot BV \cdot Z_{th}]$$

$$E_{AS(AR)} = P_{D(ave)} \cdot t_{av}$$

Fig 15. Maximum Avalanche Energy vs. Temperature

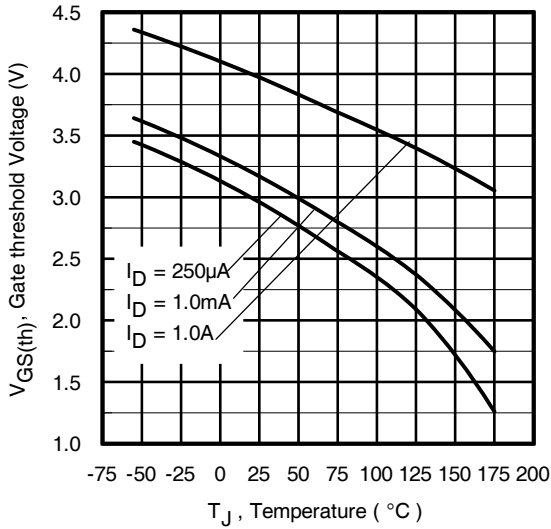
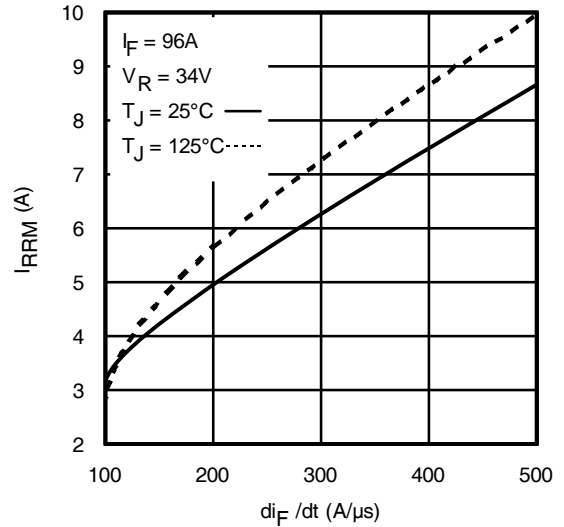
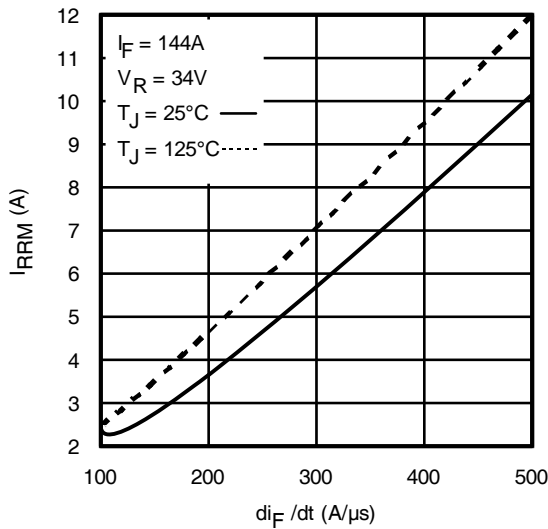
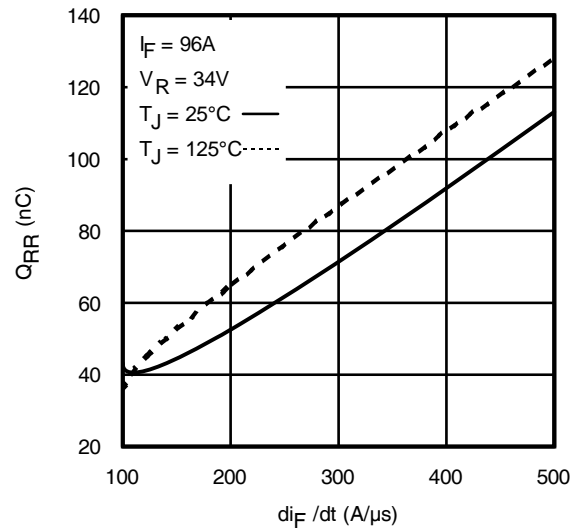
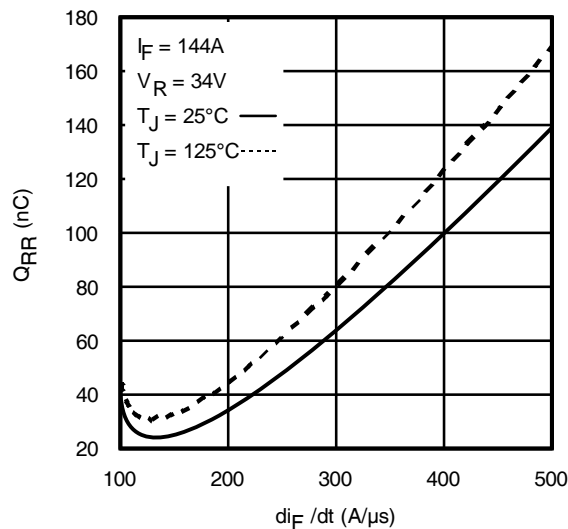
Fig. 16. Threshold Voltage vs. Temperature

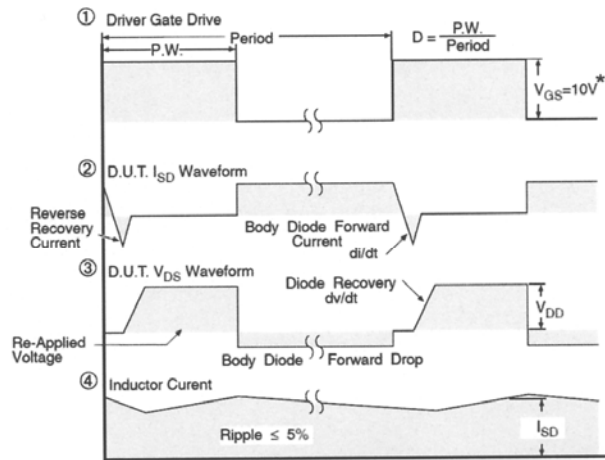
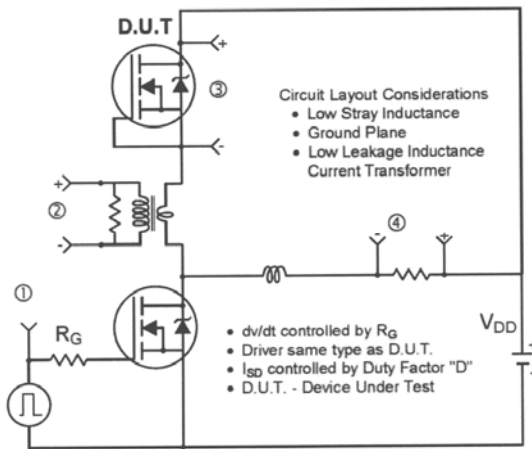
Fig. 17 - Typical Recovery Current vs. di_F/dt

Fig. 18 - Typical Recovery Current vs. di_F/dt

Fig. 19 - Typical Stored Charge vs. di_F/dt

Fig. 20 - Typical Stored Charge vs. di_F/dt



* $V_{GS} = 5V$ for Logic Level Devices

Fig 21. Peak Diode Recovery dv/dt Test Circuit for N-Channel HEXFET® Power MOSFETs

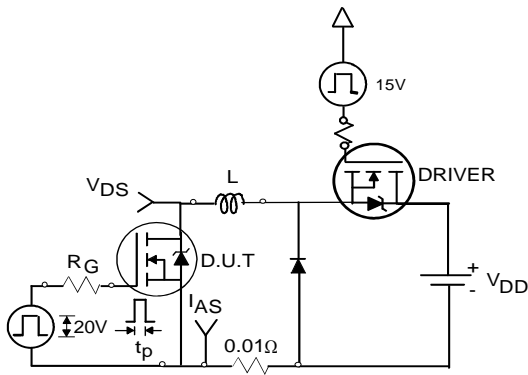

Fig 22a. Unclamped Inductive Test Circuit

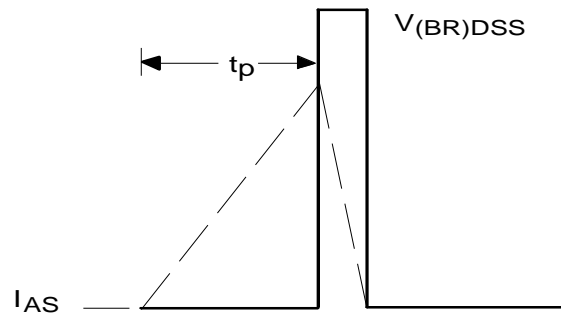

Fig 22b. Unclamped Inductive Waveforms

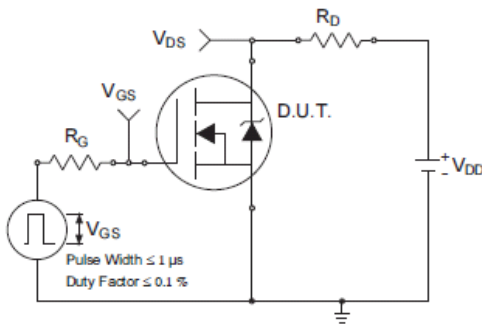

Fig 23a. Switching Time Test Circuit

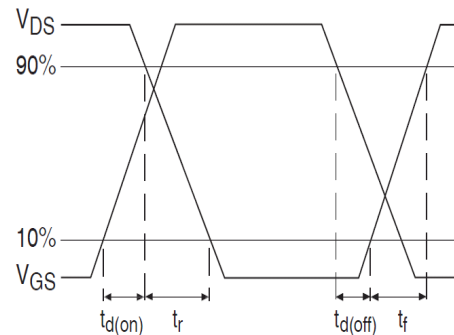

Fig 23b. Switching Time Waveforms

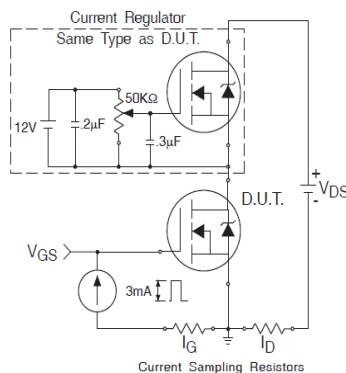

Fig 24a. Gate Charge Test Circuit

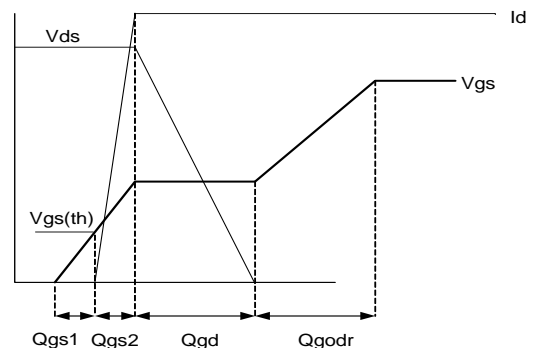
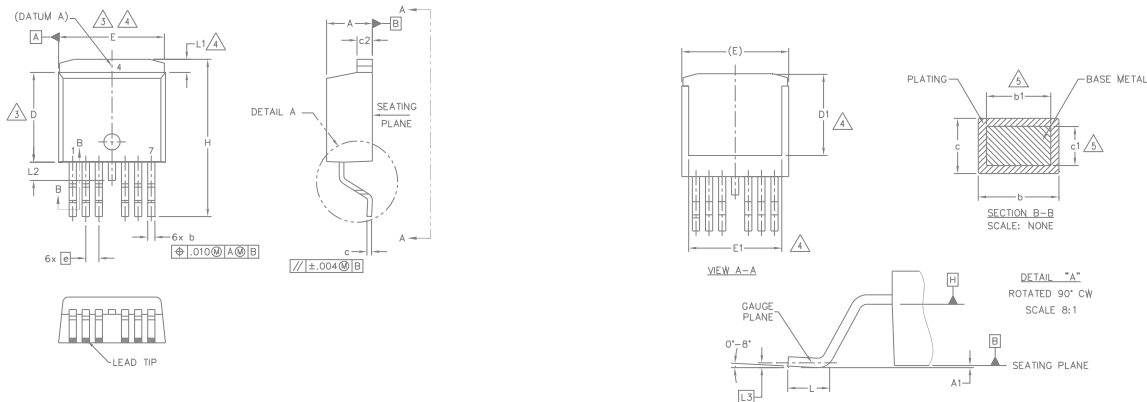

Fig 24b. Gate Charge Waveform

D²Pak - 7 Pin Package Outline (Dimensions are shown in millimeters (inches))



SYMBOL	DIMENSIONS				NOTES
	MILLIMETERS		INCHES		
	MIN.	MAX.	MIN.	MAX.	
A	4.06	4.83	.160	.190	
A1	—	0.254	—	.010	
b	0.51	0.99	.020	.036	
b1	0.51	0.89	.020	.032	5
c	0.38	0.74	.015	.029	
c1	0.38	0.58	.015	.023	5
c2	1.14	1.65	.045	.065	
D	8.38	9.65	.330	.380	3
D1	6.86	7.42	.270	.292	4
E	9.65	10.54	.380	.415	3,4
E1	6.22	8.48	.245	.334	4
e	1.27 BSC		.050 BSC		
H	14.61	15.88	.575	.625	
L	1.78	2.79	.070	.110	
L1	—	1.68	—	.066	4
L2	—	1.78	—	.070	
L3	0.25 BSC		.010 BSC		

NOTES:

1. DIMENSIONING AND TOLERANCING AS PER ASME Y14.5M-1994
2. DIMENSIONS ARE SHOWN IN MILLIMETERS [INCHES].
3. DIMENSION D & E DO NOT INCLUDE MOLD FLASH. MOLD FLASH SHALL NOT EXCEED 0.127 [“.005”] PER SIDE. THESE DIMENSIONS ARE MEASURED AT THE OUTMOST EXTREMES OF THE PLASTIC BODY AT DATUM H.
4. THERMAL PAD CONTOUR OPTIONAL WITHIN DIMENSION E, L1, D1 & E1.
5. DIMENSION b1 AND c1 APPLY TO BASE METAL ONLY.
6. DATUM A & B TO BE DETERMINED AT DATUM PLANE H.
7. CONTROLLING DIMENSION: INCH.
8. OUTLINE CONFORMS TO JEDEC OUTLINE TO-263CB. EXCEPT FOR DIMS. E, E1 & D1.

D²Pak - 7 Pin Part Marking Information

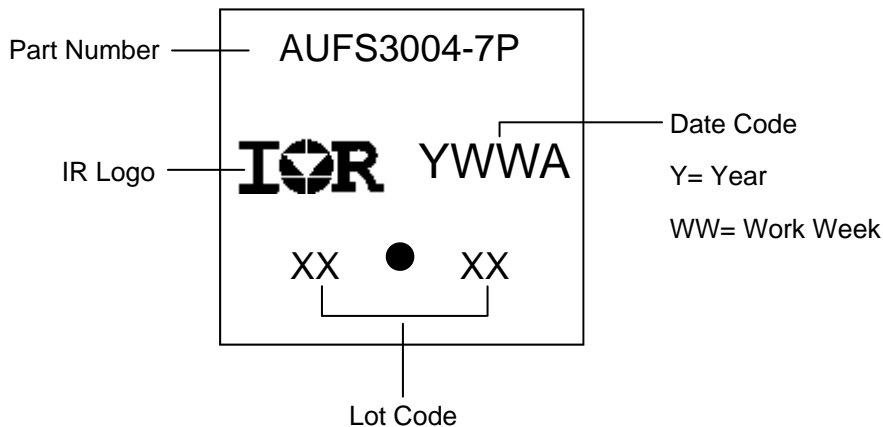

Note: For the most current drawing please refer to IR website at <http://www.irf.com/package/>

D²Pak - 7 Pin Tape and Reel

NOTES, TAPE & REEL, LABELLING:

1. TAPE AND REEL.

- 1.1 REEL SIZE 13 INCH DIAMETER.
- 1.2 EACH REEL CONTAINING 800 DEVICES.
- 1.3 THERE SHALL BE A MINIMUM OF 42 SEALED POCKETS CONTAINED IN THE LEADER AND A MINIMUM OF 15 SEALED POCKETS IN THE TRAILER.
- 1.4 PEEL STRENGTH MUST CONFORM TO THE SPEC. NO. 71-9667.
- 1.5 PART ORIENTATION SHALL BE AS SHOWN BELOW.
- 1.6 REEL MAY CONTAIN A MAXIMUM OF TWO UNIQUE LOT CODE/DATE CODE COMBINATIONS. REWORKED REELS MAY CONTAIN A MAXIMUM OF THREE UNIQUE LOT CODE/DATE CODE COMBINATIONS. HOWEVER, THE LOT CODES AND DATE CODES WITH THEIR RESPECTIVE QUANTITIES SHALL APPEAR ON THE BAR CODE LABEL FOR THE AFFECTED REEL.

2. LABELLING (REEL AND SHIPPING BAG).

- 2.1 CUST. PART NUMBER (BAR CODE): IRFXXXXSTRL-7P
- 2.2 CUST. PART NUMBER (TEXT CODE): IRFXXXXSTRL-7P
- 2.3 I.R. PART NUMBER: IRFXXXXSTRL-7P
- 2.4 QUANTITY:
- 2.5 VENDOR CODE: IR
- 2.6 LOT CODE:
- 2.7 DATE CODE:

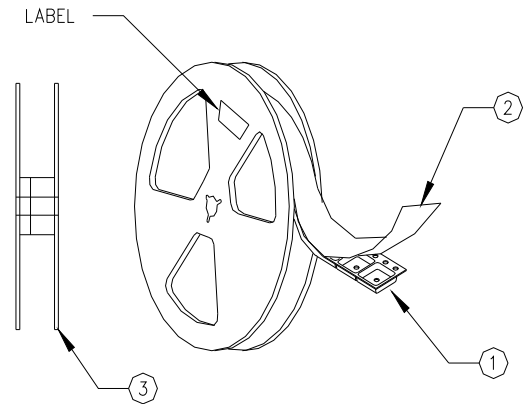
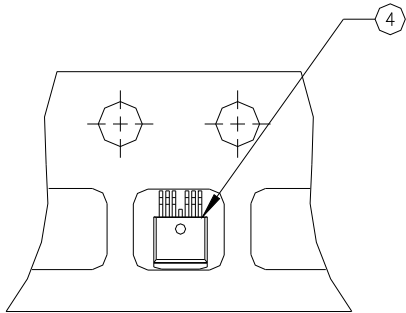

Note: For the most current drawing please refer to IR website at <http://www.irf.com/package/>

Qualification Information

Qualification Level		Automotive (per AEC-Q101)	
		Comments: This part number(s) passed Automotive qualification. Infineon's Industrial and Consumer qualification level is granted by extension of the higher Automotive level.	
Moisture Sensitivity Level		D ² -Pak 7 Pin	MSL1
ESD	Machine Model	Class M4 (+/- 800V) [†] AEC-Q101-002	
	Human Body Model	Class H3A (+/- 6000V) [†] AEC-Q101-001	
	Charged Device Model	Class C5 (+/- 2000V) [†] AEC-Q101-005	
RoHS Compliant		Yes	

† Highest passing voltage.

Revision History

Date	Comments
3/4/2015	<ul style="list-style-type: none"> Updated datasheet based on new IR corporate template . Updated part marking from "AUS3004-7P" to "AUFS3004-7P" on page 10.
10/20/2015	<ul style="list-style-type: none"> Updated datasheet with corporate template Corrected ordering table on page 1.

Published by

Infineon Technologies AG
81726 München, Germany

© Infineon Technologies AG 2015

All Rights Reserved.

IMPORTANT NOTICE

The information given in this document shall in no event be regarded as a guarantee of conditions or characteristics ("Beschaffenhheitsgarantie"). With respect to any examples, hints or any typical values stated herein and/or any information regarding the application of the product, Infineon Technologies hereby disclaims any and all warranties and liabilities of any kind, including without limitation warranties of non-infringement of intellectual property rights of any third party.

In addition, any information given in this document is subject to customer's compliance with its obligations stated in this document and any applicable legal requirements, norms and standards concerning customer's products and any use of the product of Infineon Technologies in customer's applications.

The data contained in this document is exclusively intended for technically trained staff. It is the responsibility of customer's technical departments to evaluate the suitability of the product for the intended application and the completeness of the product information given in this document with respect to such application.

For further information on the product, technology, delivery terms and conditions and prices please contact your nearest Infineon Technologies office (www.infineon.com).

WARNINGS

Due to technical requirements products may contain dangerous substances. For information on the types in question please contact your nearest Infineon Technologies office.

Except as otherwise explicitly approved by Infineon Technologies in a written document signed by authorized representatives of Infineon Technologies, Infineon Technologies' products may not be used in any applications where a failure of the product or any consequences of the use thereof can reasonably be expected to result in personal injury.