



Normally-OFF Trench Silicon Carbide Power JFET

FEATURES:

« **SemiSouth Die Inside**

- Hermetic TO-258 Packaging
- 200°C Maximum Operating Temperature (for 260°C Contact Factory)
- Available Screening:
 - MIL-PRF-19500 Equivalent
 - Space Level
 - MIL-STD-750 Methods & Conditions
- Inherent Radiation Tolerance >100K TID
- Compatible with Standard Gate Driver ICs
- Positive Temperature Coefficient for Ease of Paralleling
- Temperature Independent Switching Behavior
- Extremely Fast Switching
- 1700 Volt Drain-Source Blocking Voltage
- $R_{DS(on)max}$ of 0.550 Ω
- Voltage Controlled
- Low Gate Charge
- Low Intrinsic Capacitance

APPLICATIONS:

- Flyback Auxiliary Power Supplies for:
 - Satellite Solar Inverters
 - Mil Spec High Voltage Power Supplies
 - Switch Mode
 - Uninterrupted
- Jet Engine Electronics
- Down-hole Electronics (Motor / Compressor Control)

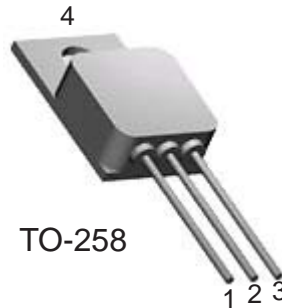

Product Summary		
BV_{DS}	1700	V
$RDS_{(ON)max}$	0.550	Ω
$E_{TS,typ}$	74	μJ

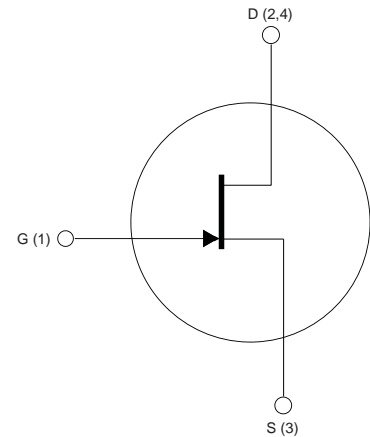

Internal Schematic

Non-isolated tab version shown. For isolated tab version, tab (4) is No Connect.

MAXIMUM RATINGS

Parameter	Symbol	Conditions	Value	Unit
Continuous Drain Current	$I_D, T_J=125$	$T_J = 125\text{ }^\circ\text{C}$	4	A
	$I_D, T_J=175$	$T_J = 175\text{ }^\circ\text{C}$	3	
Pulsed Drain Current ⁽¹⁾	I_{DM}	$T_c = 25\text{ }^\circ\text{C}$	8	A
Short Circuit Withstand Time	t_{SC}	$V_{DD} < 800\text{ V}, T_c < 125\text{ }^\circ\text{C}$	TBD	μS
Power Dissipation	P_D	$T_c = 25\text{ }^\circ\text{C}$	58	W
Gate-Source Voltage	V_{GS}	AC ⁽²⁾	-15 to +15	V
Operating and Storage Temperature	$T_j, T_{j,stg}$		-55 to +200*	$^\circ\text{C}$
Lead Temperature for Soldering	T_{sold}	1/8" from case < 10 s	260	$^\circ\text{C}$

(1) Limited by pulse width

(2) $R_{gEXT} = 1\text{ ohm}, t_p < 200\text{ns}$, see Figure 5 for static conditions

*Contact factory for 260°C

THERMAL CHARACTERISTICS

Parameter	Symbol	Value		Unit
		Typ	Max	
Thermal Resistance, junction-to-case	$R_{th,JC}$	-	TBD	$^\circ\text{C} / \text{W}$
Thermal Resistance, junction-to-ambient	$R_{th,JA}$	-	TBD	

For more products and information, please visit our website at www.micross.com



ELECTRICAL CHARACTERISTICS

Parameter	Symbol	Conditions	Value			Unit	
			Min	Typ	Max		
Off Characteristics							
Drain-Source Blocking Voltage	BV_{DS}	$V_{GS} = 0\text{ V}, I_D = 200\ \mu\text{A}$	1700	-	-	V	
Total Drain Leakage Current	I_{DSS}	$V_{DS} = 1700\text{ V}, V_{GS} = 0\text{ V}, T_J = 25^\circ\text{C}$	-	10	200	μA	
		$V_{DS} = 1700\text{ V}, V_{GS} = 0\text{ V}, T_J = 175^\circ\text{C}$	-	50	1000		
		$V_{DS} = 1700\text{ V}, V_{GS} = -15\text{ V}, T_J = 25^\circ\text{C}$	-	10	-		
		$V_{DS} = 1700\text{ V}, V_{GS} = -15\text{ V}, T_J = 175^\circ\text{C}$	-	30	-		
Total Gate Reverse Leakage	I_{GSS}	$V_{GS} = -15\text{ V}, V_{DS} = 0\text{ V}$	-	-0.02	-0.1	mA	
		$V_{GS} = -15\text{ V}, V_{DS} = 1700\text{ V}$	-	-0.02	-		
On Characteristics							
Drain-Source On-resistance	$R_{DS(on)}$	$I_D = 3\text{ A}, V_{GS} = 3\text{ V}, T_J = 25^\circ\text{C}$	-	0.45	0.55	Ω	
		$I_D = 3\text{ A}, V_{GS} = 3\text{ V}, T_J = 125^\circ\text{C}$	-	1.08	-		
Gate Threshold Voltage	$V_{GS(th)}$	$V_{DS} = 1\text{ V}, I_D = 10\text{ mA}$	1.15	1.4	1.75	V	
Gate Forward Current	I_{GFWD}	$V_{GS} = 3\text{ V}$	-	135	-	mA	
Gate Resistance	R_G	$f = 1\text{ MHz}, \text{ drain-source shorted}$	-	15	-	Ω	
	$R_{G(on)}$	$V_{GS} > 2.7\text{ V}; \text{ See Figure 5}$	-	1	-	Ω	
Dynamic Characteristics							
Input Capacitance	C_{iss}	$V_{DD} = 300\text{ V}$	-	170	-	μF	
Output Capacitance	C_{oss}		-	20	-		
Reverse Transfer Capacitance	C_{rss}		-	17	-		
Effective Output Capacitance, energy related	$C_{O(er)}$	$V_{DS} = 0\text{ V to } 600\text{ V}, V_{GS} = 0\text{ V}$	-	20	-		
Switching Characteristics							
Turn-On Delay	t_{on}	$V_{DS} = 850\text{ V}, I_D = 3\text{ A},$ Inductive Load, $T_J = 25^\circ\text{C}$ Gate Driver = +15V unipolar $R_{GEXT} = 20\text{ohm}$ See Figure 14 for typical gate drive / inductive load switching circuit.	-	12	-	ns	
Rise Time	t_r		-	14	-		
Turn-Off Delay	t_{off}		-	28	-		
Fall Time	t_f		-	30	-		
Turn-On Energy	E_{on}		See Figure 14 for typical gate drive / inductive load switching circuit.	-	41	-	μJ
Turn-Off Energy	E_{off}			-	33	-	
Total Switching Energy	E_{ts}			-	74	-	
Turn-On Delay	t_{on}	$V_{DS} = 850\text{ V}, I_D = 3\text{ A},$ Inductive Load, $T_J = 150^\circ\text{C}$ Gate Driver = +15V unipolar $R_{GEXT} = 20\text{ohm}$ See Figure 14 for typical gate drive / inductive load switching circuit.	-	TBD	-	ns	
Rise Time	t_r		-	TBD	-		
Turn-Off Delay	t_{off}		-	TBD	-		
Fall Time	t_f		-	TBD	-		
Turn-On Energy	E_{on}		See Figure 14 for typical gate drive / inductive load switching circuit.	-	TBD	-	μJ
Turn-Off Energy	E_{off}			-	TBD	-	
Total Switching Energy	E_{ts}			-	TBD	-	
Total Gate Charge	Q_g	$V_{DS} = 850\text{ V}, I_D = 3\text{ A},$ $V_{GS} = +2.5\text{ V}$	-	10	-	nC	
Gate-Source Charge	Q_{gs}		-	8	-		
Gate-Drain Charge	Q_{gd}		-	1	-		



Figure 1. Typical Output Characteristics

$I_D = f(V_{DS}); T_j = 25\text{ }^\circ\text{C}; \text{parameter: } V_{GS}$

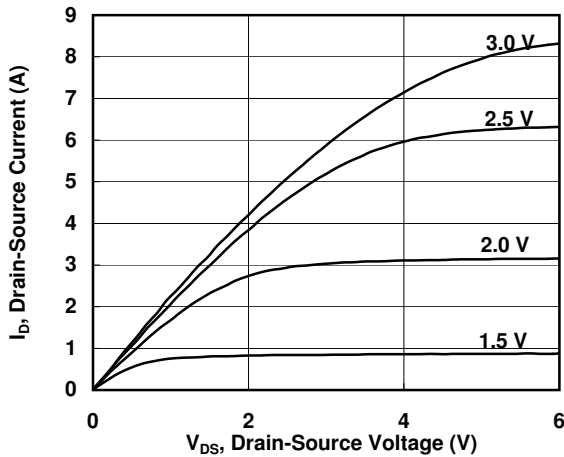

Figure 2. Typical Output Characteristics

$I_D = f(V_{DS}); T_j = 125\text{ }^\circ\text{C}; \text{parameter: } V_{GS}$

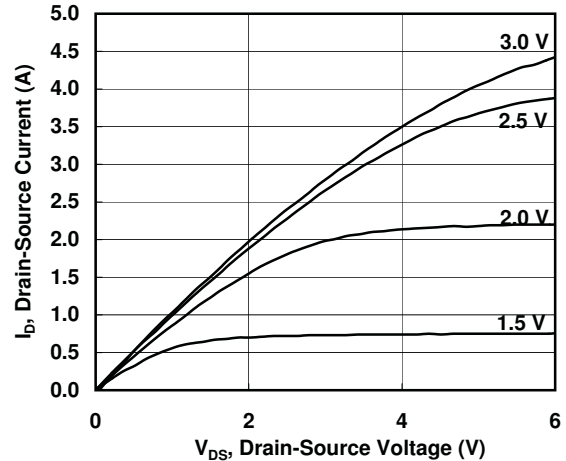

Figure 3. Typical Output Characteristics

$I_D = f(V_{DS}); T_j = 175\text{ }^\circ\text{C}; \text{parameter: } V_{GS}$

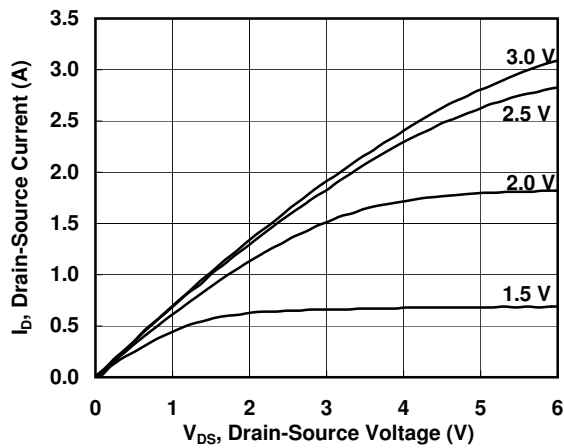

Figure 4. Typical Transfer Characteristics

$I_D = f(V_{GS}); V_{DS} = 5\text{V}$

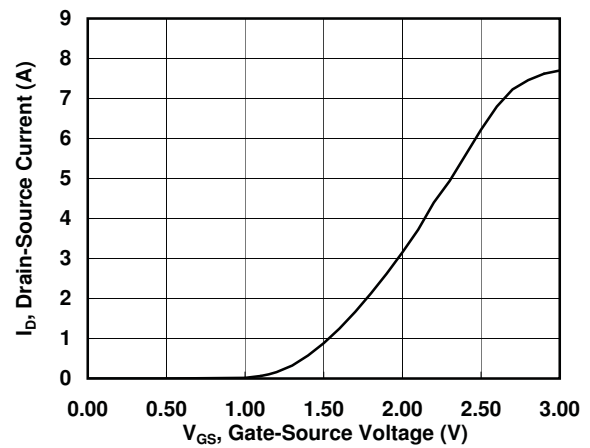

Figure 5. Gate-Source Current

$I_{GS} = f(V_{GS}); \text{parameter: } T_j$

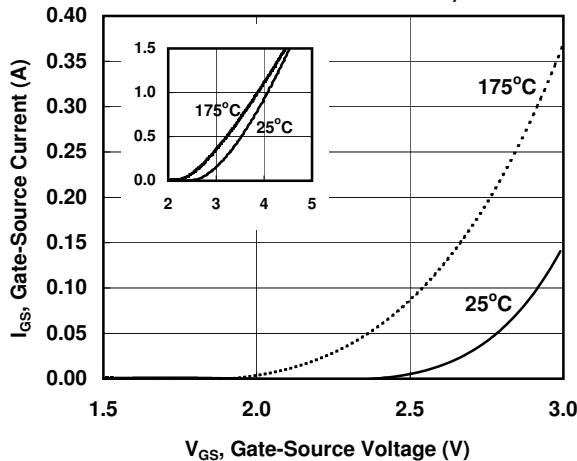

Figure 6. Drain-Source On-resistance

$R_{DS(on)} = f(I_D); V_{GS} = 3.0; \text{parameter: } T_j$

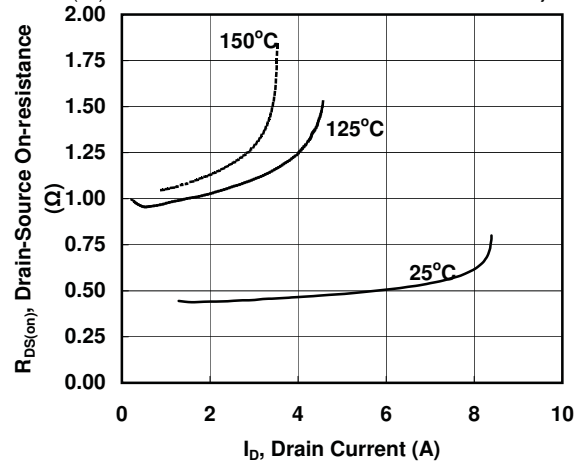



Figure 7. Drain-Source On-resistance

$$R_{DS(ON)} = f(T_j); \text{ parameter: } I_{GS}$$

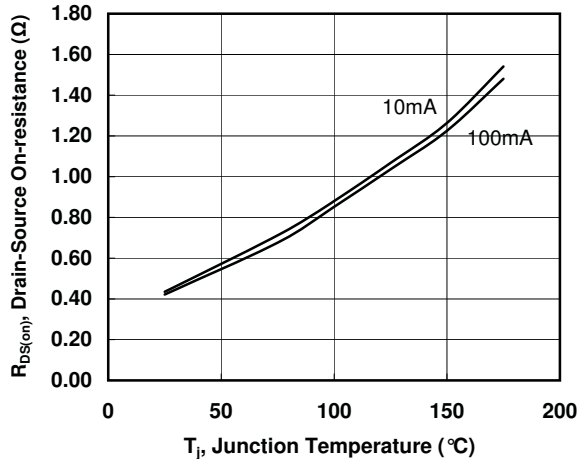

Figure 8. Drain-Source On-resistance

$$R_{DS(ON)} = f(I_{GS}); T_j = 25^{\circ}C$$

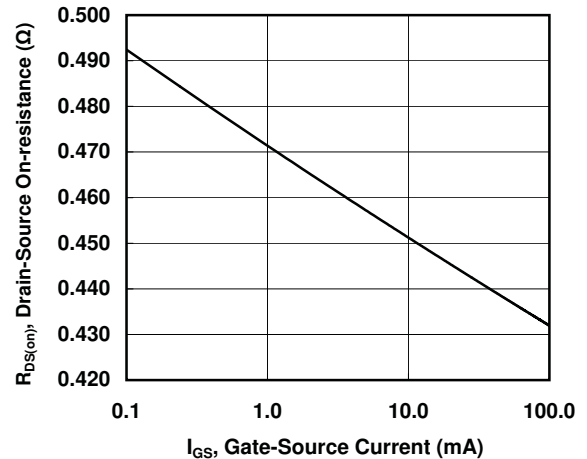

Figure 9. Typical Capacitance

$$C = f(V_{DS}); V_{GS} = 0V; f = 1MHz$$

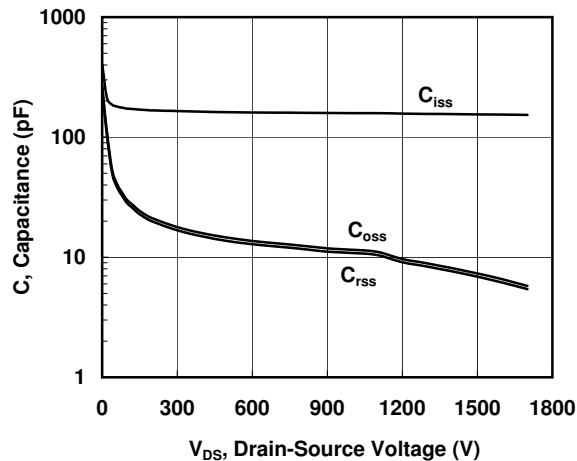

Figure 10. Gate Charge

$$Q_g = f(V_{GS}); V_{DS} = 900V; I_D = 3A; T_j = 25^{\circ}C$$

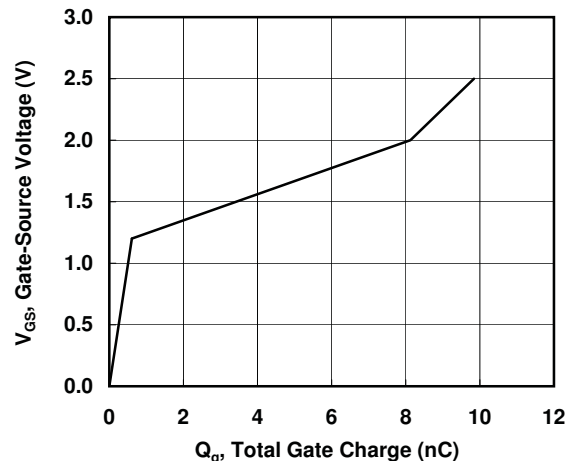

Figure 11. Gate Threshold Voltage

$$V_{th} = f(T_j), \text{ normalized}$$

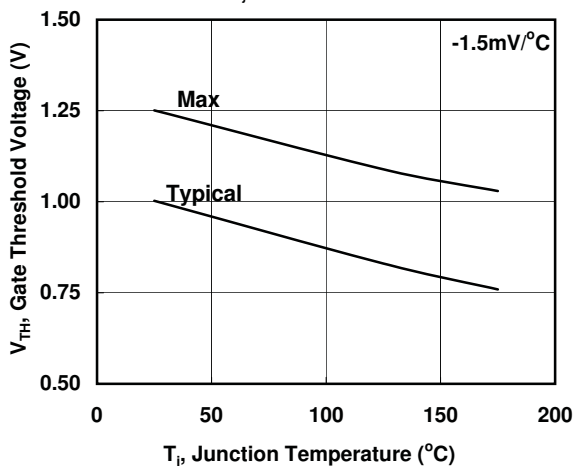

Figure 12. Drain-Source Leakage

$$I_D = f(V_{DS}); V_{GS} = 0V; \text{ parameter: } T_j$$

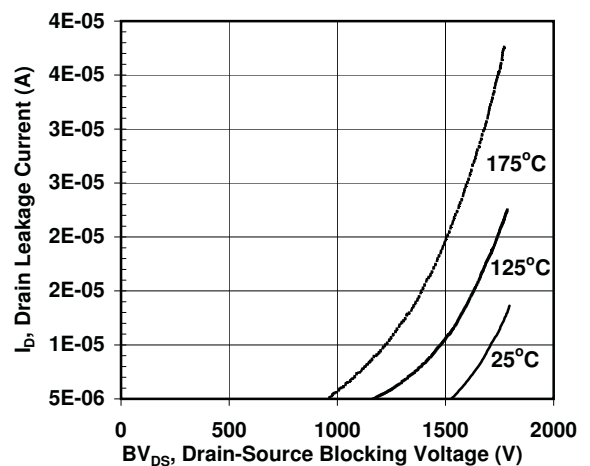



Figure 13. Switching Energy Losses

$E_s = f(I_D); V_{DS} = 850V; V_{GD} = +15V, R_{GEXT} = 20\text{ohm}; T_C = 25^\circ\text{C}$

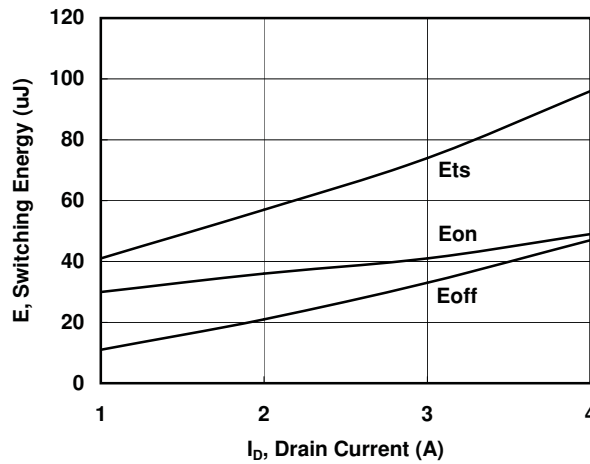
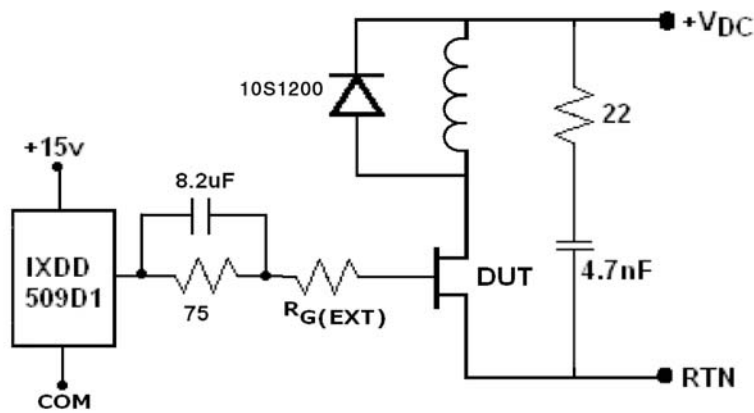
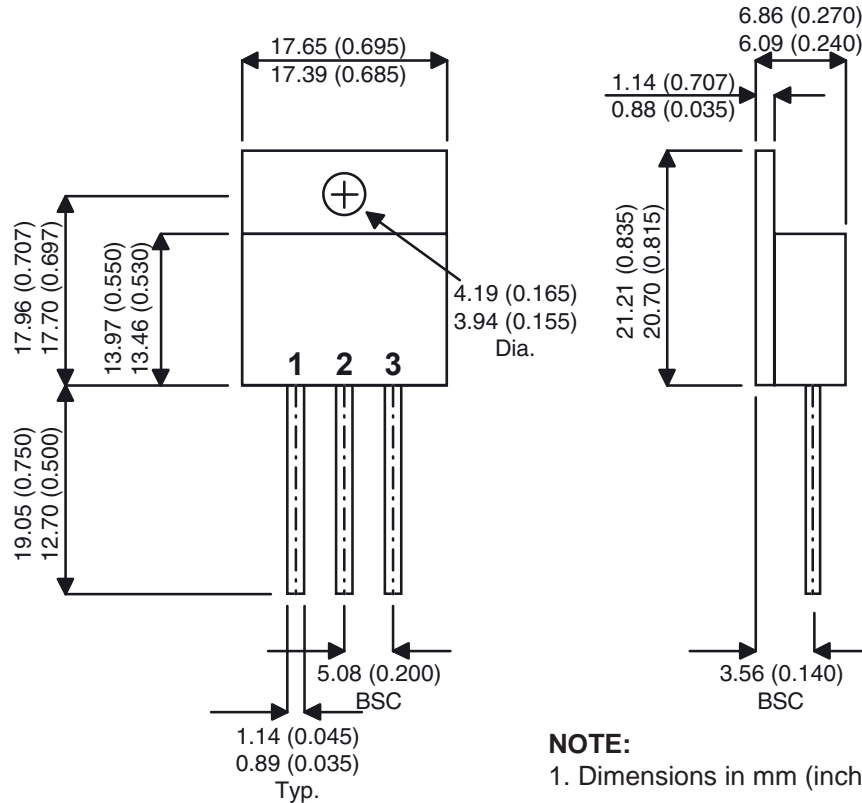

Figure 14. Inductive Load Switching Circuit





MECHANICAL DRAWING



- NOTE:**
1. Dimensions in mm (inches)
 2. Controlling dimensions (inches)

ORDERING INFORMATION

<u>Base Part Number</u>	<u>Configuration</u>	<u>Package</u>	<u>Junction Temp. Range</u>	<u>Processing</u>
ASJE1700R550	Blank= Non-isolated Tab S= Isolated Tab	M=TO-258 -	EL EX	Blank /V /S

Temp Ranges: EL= Elevated Temp. Range, -55°C to 200°C (T_J)
EX= Extreme Temp. Range, -55°C to 260°C (T_J) (consult factory)

Processing: Blank = Commercial / Standard Processing
MIL-PRF-19500 Equivalent Screening Available Per SCD
/V= JANTX MIL-PRF-19500 Equivalent (future standard offering)
/S= JANS MIL-PRF-19500 Equivalent (future standard offering)

Example Part Numbers: ASJE1700R550SM-EL
ASJE1700R550M-EX

SemiSouth has commercial plastic versions of this product available. Please refer to the SemiSouth website <http://www.semisouth.com/products/products.html> for datasheet specifications and ordering information. The SemiSouth part number is SJEP170R550 and is supplied in a TO-247 plastic package.



DOCUMENT TITLE

Normally-OFF Trench Silicon Carbide Power JFET

<u>Rev #</u>	<u>History</u>	<u>Release Date</u>	<u>Status</u>
0.0	Initial Release	December 2010	Advance Information
0.1	Replaced TO-257 package with TO-258 package	June 2011	Advance Information