

Abdeckung vorverrastet
cover loose mounted

Abdeckung verpresst
cover pressed on

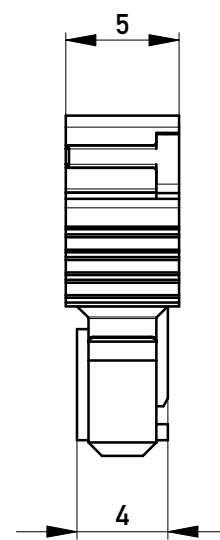

Verpackt in Tray - tray packaging
Verpackungseinheit 154 Stück - packaging unit 154

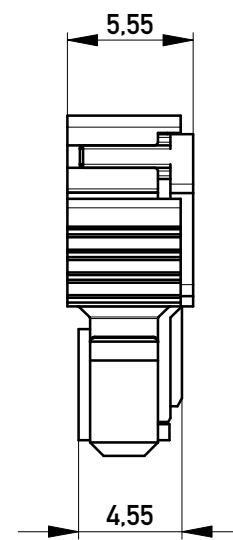
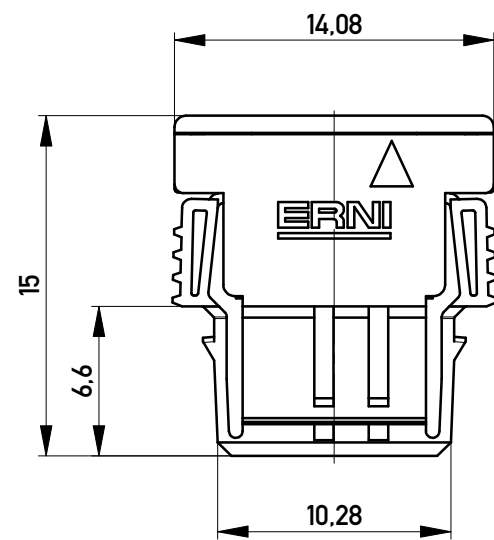
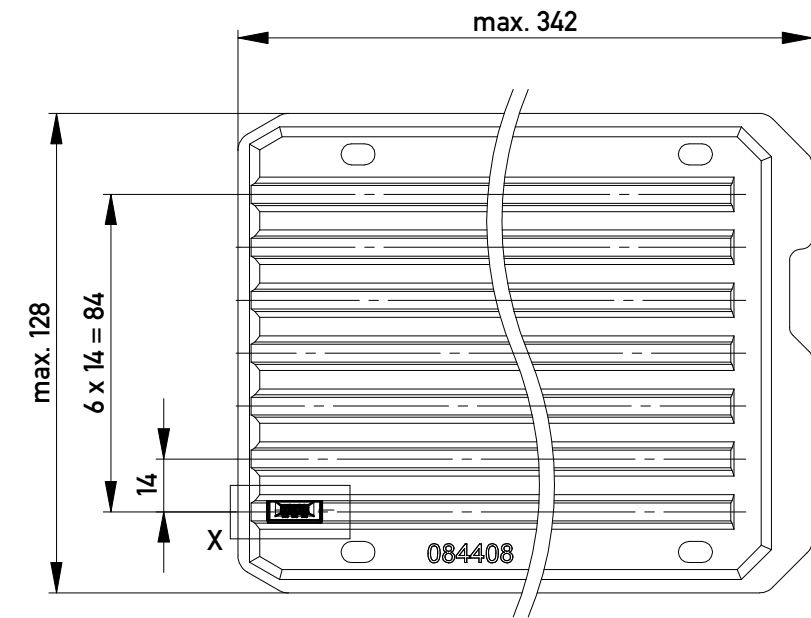

Einzelheit X
detail X

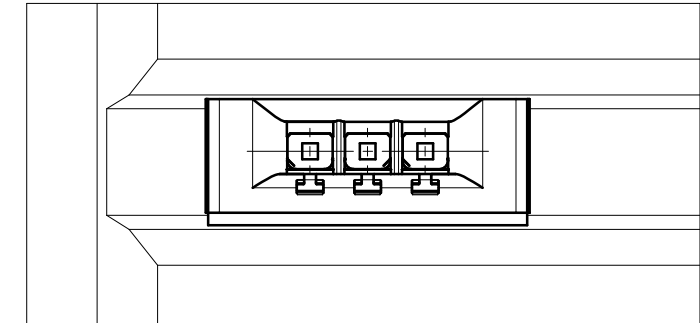

Copyright by ERNI GmbH
Proprietary notice pursuant to ISO 16016 to be observed.

Information: Codierung schwarz - coding black		Tolerances		Scale	3:1
All rights reserved. Only for Information. To ensure that this is the latest version of this drawing, please contact one of the ERNI companies before using.		Subject to modification without prior notice. Drawing will not be updated.		Designation F 2.54 SRC-A, 3-polig BA 2	
		www.ERNI.com		100103680003	
d	01.02.2016			K	
Index	Date			A3	
				Class	SRCBUG