

Industrial Grade AC/DC Power Supply With PFC

85-264 Vrms Input Voltage	12/24/36/48 V Semi-Regulated Output	400 W Output Continuous	500 W Output Transient	Up to Up to 91 % Full Load Efficiency
------------------------------	--	----------------------------	---------------------------	--

Includes 5 V (10 W) and 12 V (50 W) "Always On" Standby Power Outputs

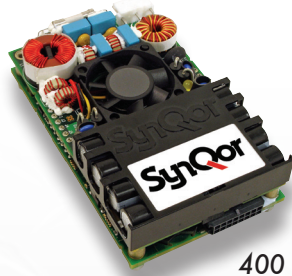

400 W Open Frame



400 W Encased

Configurations

- 400 W Encased or Open Frame
- 800 W Encased Flat or Stacked
- 1200 W Encased Flat or Stacked



1200 W Encased Stacked



800 W Encased Flat

Product Features

- High efficiency (91% for 48 VOUT Model at 400 W)
- Universal input voltage range
- Semi-regulated output for bus stability
- Parallel operation supported
- Integral fan cooling with speed control
- Active PFC; EN61000-3-2 compliant
- Low leakage; EN60601-1 compliant
- Low noise; EN55011 / EN55022 Class B compliant
- Over-current, over-voltage, & over-temp protection
- DC Power Good / AC Power Good signals
- Remote enable input
- Fan status output / Fan enable input
- Small size: 3" x 5" x 1.45" (open frame)
- RoHS 6/6 compliant
- 5 V (10 W) and 12 V (50 W) standby outputs



Technical Specification

AC Input: 85-264 Vrms
DC Output: 12/24/36/48 V Semi-reg.
Power: 400 W
Grade: Industrial

ACuQor 400W Triple Vout Series Electrical Characteristics

All specifications typical with $T_a = 25\text{ }^\circ\text{C}$, unless otherwise specified. Specifications subject to change without notice.

MAIN OUTPUT SPECIFICATIONS			GENERAL SPECIFICATIONS		
Output power (continuous) (5 s transient)	85-132/170-264 Vrms 85-132/170-264 Vrms 132-170 Vrms	400 W (Note 1) 500 W (Note 1) See Figures 10	Fundamental ripple freq.	Input Output	500 kHz 250 kHz
Nominal DC output voltage (at 250W) (Semi-regulated)	12 Vout (model 1T) 24 Vout (model 2T) 36 Vout (model 3T) 48 Vout (model 4T)	12.4 V 25 V 37.5 V 50 V	Audible noise	Fan speed varies with temp. 39 dBA @ 1 m max.	
Efficiency (see figs. 1, 3, 5, 7) (see Note 1)	12 Vout, 115 Vrms, 400 W 48 Vout, 115 Vrms, 400 W 12 Vout, 230 Vrms, 400 W 48 Vout, 230 Vrms, 400 W	88% typ. 90% typ. 89% typ. 91% typ.	Weight (EA \ EC) (SC \ RC) (UC \ TC)	343 g (12.1 oz) \ 446 g (15.7 oz) 846 g (29.8 oz) \ 879 g (31 oz) 1224 g (43.2 oz) \ 1298 g (45.8 oz)	
Hold-up time (to -20%) (see Note 1)	12 Vout 24 / 36 / 48 Vout	16 ms @ 400 W 20 ms @ 400 W	MTBF	MIL-217 Demonstrated	343.6 kHours TBD kHours
Maximum load capacitance	12 Vout 24 Vout 36 Vout 48 Vout	16,000 μF 8,000 μF 4,000 μF 2,000 μF	ISOLATION SPECIFICATIONS		
Output ripple voltage	Switching frequency (20 MHz BW) Twice line frequency (at 300W)	0.5% p-p 5.0% p-p	Isolation voltage	Input to output Input to ground Output to ground	3000 Vrms 1500 Vrms 500 Vrms
Turn-on delay	2 s max.		Insulation resistance	Output to ground	10 M Ω min.
Transient response	Iout steps from 50-75% At 0.2 A/ μs	3% typ / 6% max. dev. 100 ms recovery	Leakage currents	See Note 2	
Oversvoltage protection	Cyclic restart	110-120%	ENVIRONMENTAL CHARACTERISTICS		
Short circuit protection	Cyclic operation	115% rated Iout	Thermal performance	Operating ambient (see Figure 2) Non-operating ambient	-40 $^\circ\text{C}$ to +70 $^\circ\text{C}$ -40 $^\circ\text{C}$ to +85 $^\circ\text{C}$
Total regulation	Over line, load and temperature	$\pm 6.0\%$	Relative humidity	Non-condensing	5-95% RH
12V_STANDBY cross-reg.	ΔVout caused by 50 W step	0.5%	Altitude	Operating Non-operating	10,000 ft max. 30,000 ft max.
5V_STANDBY cross-reg.	ΔVout caused by 10 W step	0.1%	Random vibration	5-500 Hz	0.03 g2/Hz
Thermal protection	Automatic recovery	+125 $^\circ\text{C}$ (PCB Temp)	Shock	Half-sine, 10 ms, 3 axes	20 g peak
REMOTE_ENABLE	Input Low Voltage Input High Voltage	0.45 V (max) 4.15 V (min)	EMC CHARACTERISTICS		
12V_STANDBY OUTPUT SPECIFICATIONS			Conducted emissions	EN55011 and EN55022, FCC part15	Level B
Output power	85-264 Vrms	50 W	Line frequency harmonics	EN61000-3-2	Class A
Nominal DC output voltage	Semi-regulated	12.4 V	Voltage fluctuations	EN61000-3-3	Clause 5b
Total regulation	Over line, load and temperature	$\pm 6.0\%$	ESD air	EN61000-4-2	Level 3
Main output cross-reg.	$\Delta 12\text{V_STANDBY}$ caused by $\Delta 350\text{W}$ on main output	400 mV	ESD contact	EN61000-4-2	Level 3
Output ripple	Switching frequency (20 MHz BW) Twice line frequency	10 mV 0.45 Vrms	Radiated immunity	EN61000-4-3	Level 3
Output current	Continuous	4.2 A	Fast transients	EN61000-4-4	Level 3
Short circuit protection	Cyclic operation	5.0 A	Line surge immunity	EN61000-4-5	Level 3
Maximum load capacitance	2,000 μF		Conducted immunity	EN61000-4-6	Level 3
5V_STANDBY OUTPUT SPECIFICATIONS			Power freq. mag. field	EN61000-4-8	3 A/m
Output power	85-264 Vrms	10 W	Voltage dip immunity	EN61000-4-11	Perf Criteria A, A, B <5% UT 10 ms, 70% UT 500 ms, 40% UT 100 ms
Nominal DC output voltage	Fully regulated	5.0 V	NOTES:		
Total regulation	Over line, load and temperature	$\pm 5.0\%$	1. Main output power rating always includes 5 V and 12 V standby outputs.		
Output current	Continuous	2.0 A	2. Leakage currents see page 5.		
Short circuit protection	Cyclic operation	2.5 A			
Maximum load capacitance	1,000 μF				
INPUT SPECIFICATIONS					
AC input voltage	Universal range	85-264 Vrms			
Input frequency	47-63 Hz				
Input current (see Note 1)	115 Vrms @ 400 W 230 Vrms @ 400 W	4 Arms 2 Arms			
Power factor	>0.98				
Input surge current	264 Vrms (cold start)	40 A max.			
Internal input fuses	Both AC lines	6.3 A			

EFFICIENCY, DERATING, AND VOUT DROOP CURVES

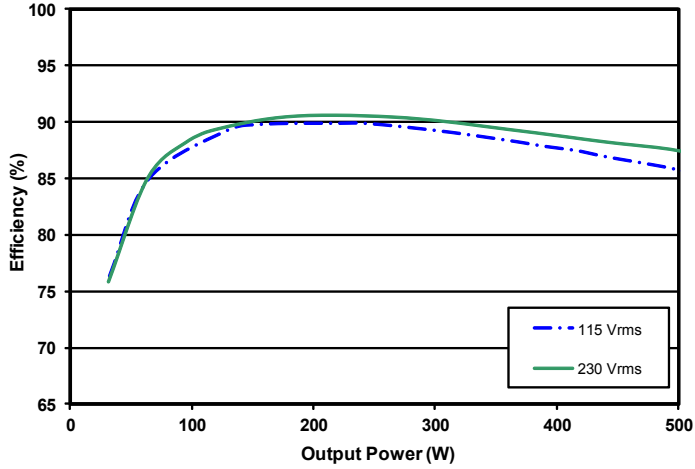

Figure 1: 12 V_{OUT} efficiency curves.

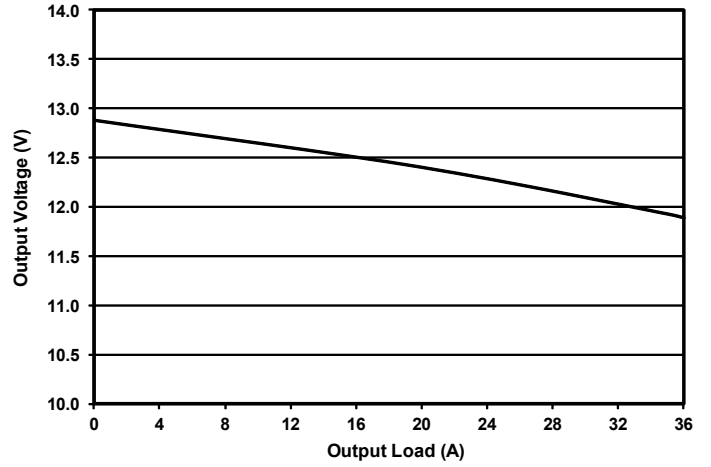

Figure 2: 12 V_{OUT} droop characteristic.

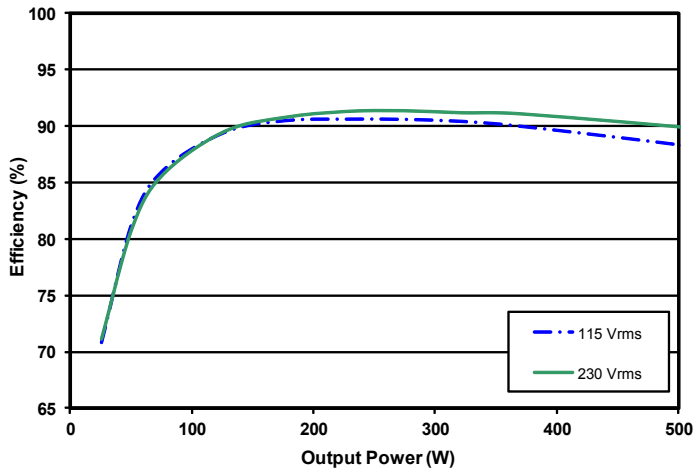

Figure 3: 24 V_{OUT} efficiency curves.

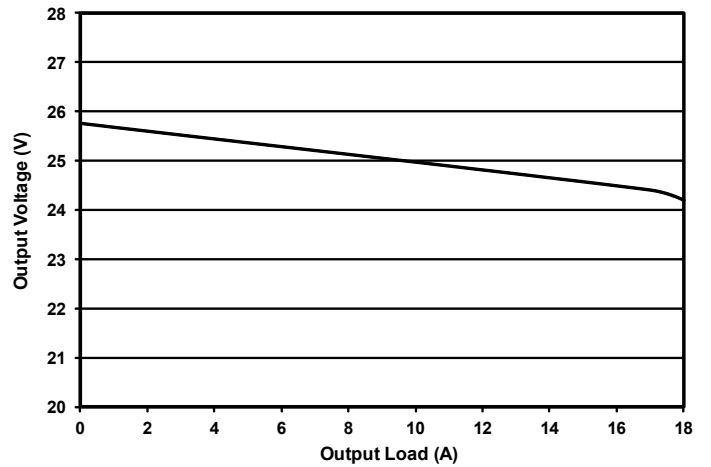

Figure 4: 24 V_{OUT} droop characteristic.

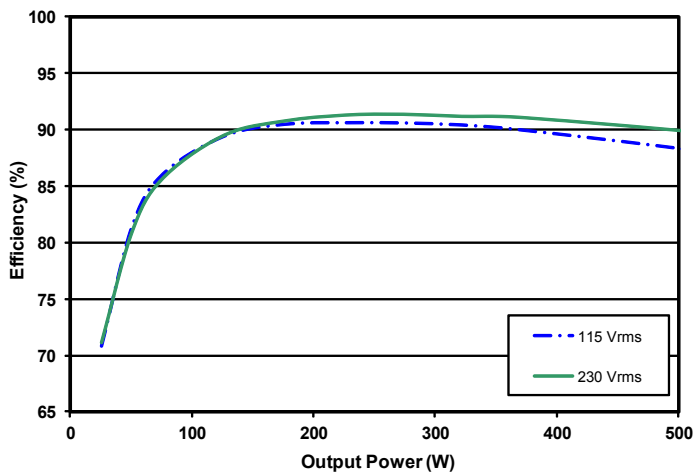

Figure 5: 36 V_{OUT} efficiency curves.

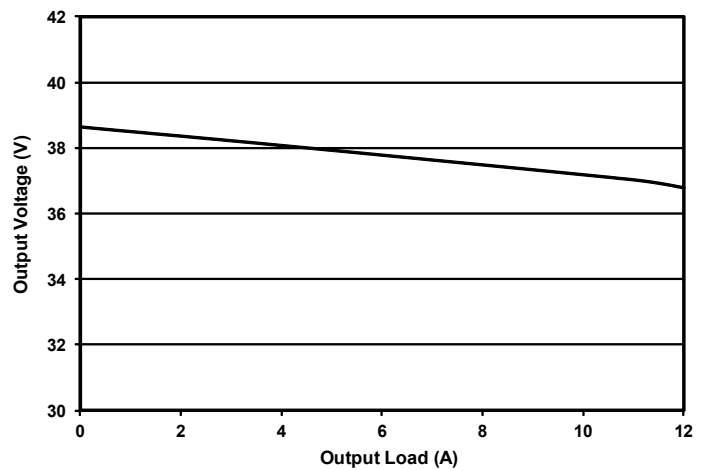

Figure 6: 36 V_{OUT} droop characteristic.

EFFICIENCY, DERATING, AND VOUT DROOP CURVES

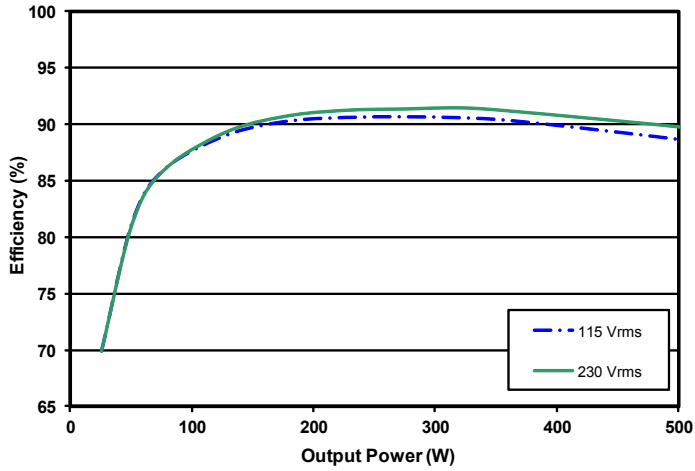

Figure 7: 48 V_{OUT} efficiency curves.

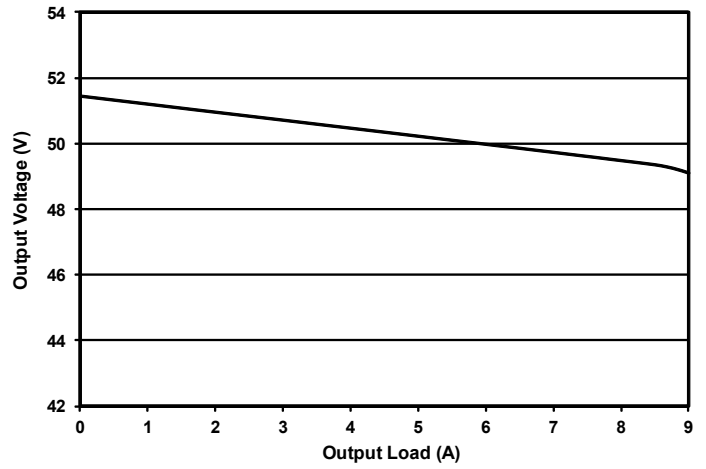

Figure 8: 48 V_{OUT} droop characteristic.

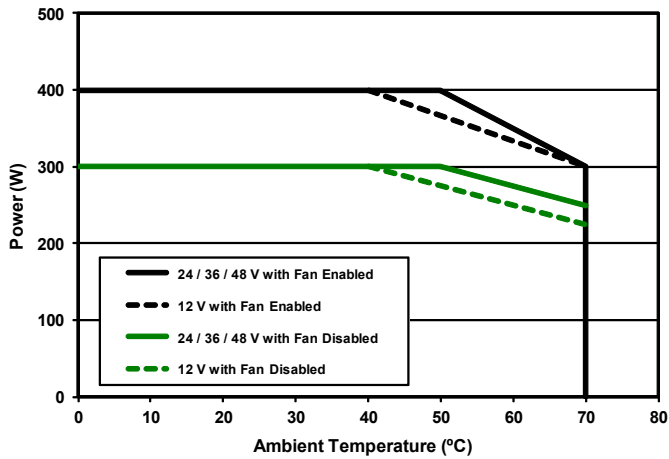

Figure 9: Continuous power derating curve in natural convection

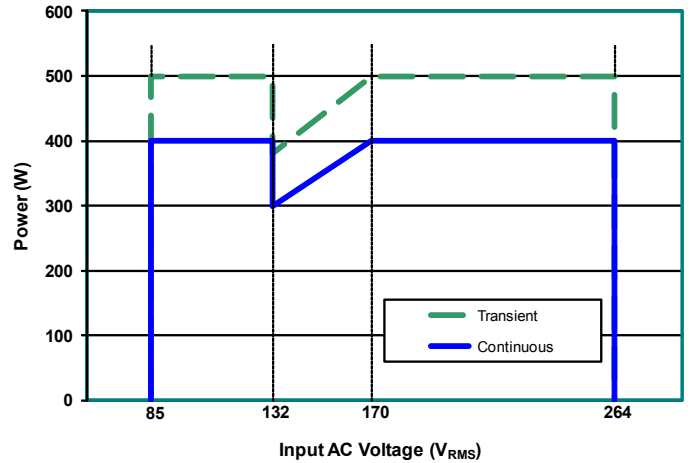

Figure 10: Rated output power vs Input AC Voltage



Technical Specification

AC Input: 85-264 Vrms
DC Output: 12/24/36/48 V Semi-reg.
Power: 400 W
Grade: Industrial

Leakage Currents

AC Leakage Current from Input to Earth	AC Line Connection	Normal Condition	Open Neutral Fault
ACuQor Typical at 110% nominal input voltage 60 Hz	240 V L-N, 1 phase	400 μ A	800 μ A
	208 V L-L, 120 V L-N, 1 of 3 phases	200 μ A	400 μ A
	240 V L-N-L, 120 V L-N, split phase	200 μ A	400 μ A

Standard Testing Certifications

SAFETY AGENCY CERTIFICATIONS

CAN/CSA-C22.2 No. 60950-1:2007

UL 60950-1:2007

EN 60950-1/A1:2010

CE Marked

CONNECTOR DETAILS

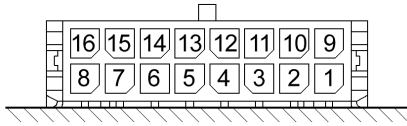

OUTPUT CONNECTOR PINOUT (top side)

Pin 1	FAN_GOOD	Open collector with internal 5V pullup. See Figure A. Pulsed low on fan failure, 100ms, 50% duty. Short to VOUT(-) to disable fan.
Pin 2	AC_POWER_GOOD	Open collector with internal 5V pullup. See Figure B. Pulled low on AC power dropout.
Pin 3	DC_POWER_GOOD	Open collector with internal 5V pullup. See Figure B. Pulled low during startup ramp and within 5 °C of temperature shutdown threshold.
Pin 4	5V_STANDBY	5 V @ 10 W available whenever AC power is applied.
Pin 5	VOUT(+)	Positive Output Voltage.
Pin 6	VOUT(+)	Positive Output Voltage.
Pin 7	VOUT(+)	Positive Output Voltage.
Pin 8	VOUT(+)	Positive Output Voltage.
Pin 9	Reserved	Reserved for future use.
Pin 10	Reserved	Reserved for future use.
Pin 11	REMOTE_ENABLE	Logic input. See Figure C. Pull high to enable main output.
Pin 12	12V_STANDBY	12 V @ 50 W available whenever AC power is applied.
Pin 13	VOUT(-)	Negative Output Voltage.
Pin 14	VOUT(-)	Negative Output Voltage.
Pin 15	VOUT(-)	Negative Output Voltage.
Pin 16	VOUT(-)	Negative Output Voltage.

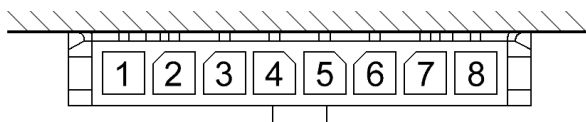

12 V OUTPUT CONNECTOR PINOUT (bottom side)

Pin 1	VOUT(+)	Positive Output Voltage.
Pin 2	VOUT(+)	Positive Output Voltage.
Pin 3	VOUT(+)	Positive Output Voltage.
Pin 4	VOUT(+)	Positive Output Voltage.
Pin 5	VOUT(-)	Negative Output Voltage.
Pin 6	VOUT(-)	Negative Output Voltage.
Pin 7	VOUT(-)	Negative Output Voltage.
Pin 8	VOUT(-)	Negative Output Voltage.

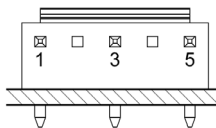

INDIVIDUAL INPUT CONNECTOR PINOUT

Pin 1	Ground
Pin 3	AC Neutral
Pin 5	AC Line

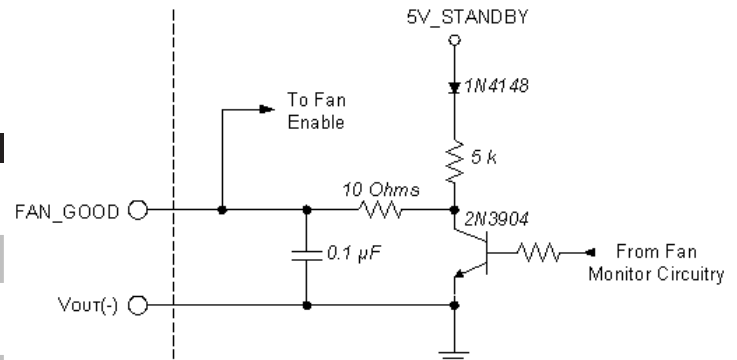

Figure A: Fan status output / Fan enable input interface circuitry.

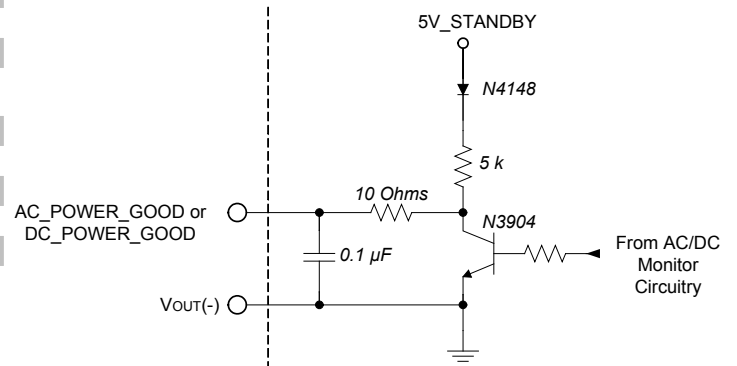

Figure B: Power good interface circuitry.

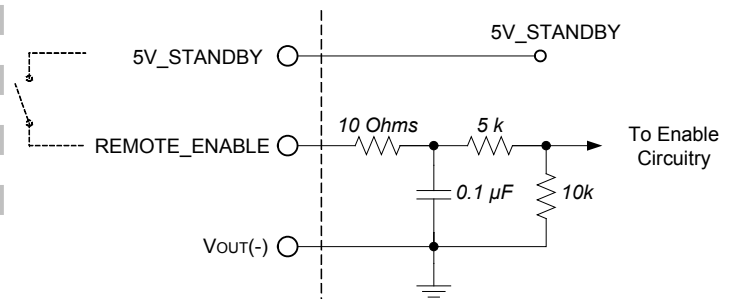

Figure C: Remote enable interface circuitry.

MATING CONNECTORS

Connector	Type	Contact
OUTPUT (16 pins)	Molex 430251600	Molex 430300008*
12V_OUTPUT (8 pins)	Molex 436450800	Molex 430300008*
INPUT	JST VHR-5N	JST SVH-41T-P1.1

* Each contact rated for a maximum of 5.5 A.

Technical Specification

MECHANICAL DRAWINGS

(1 Module Open Frame Version — E Package Type)

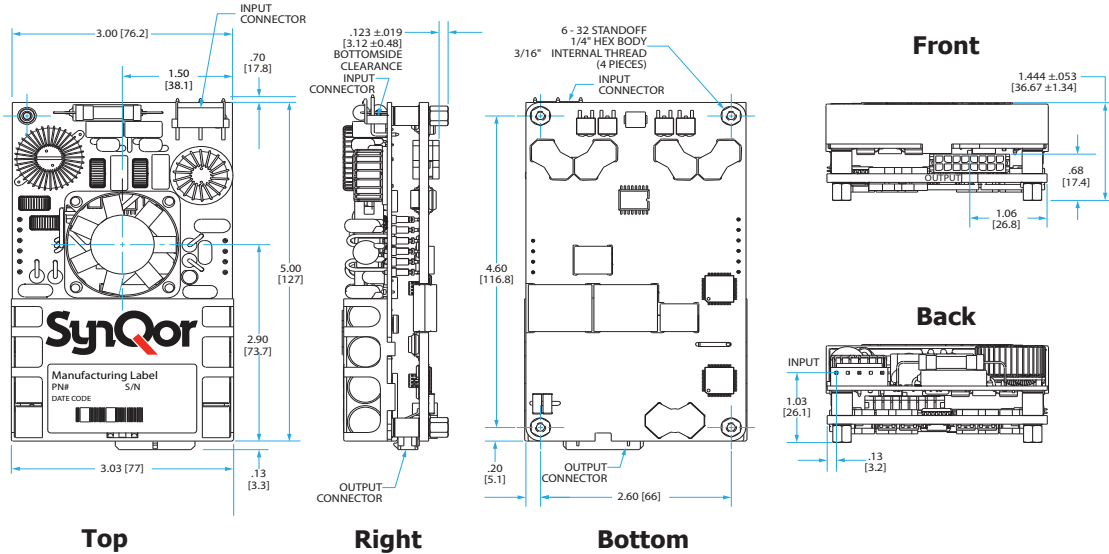

(1 Module Encased Version — E Package Type)

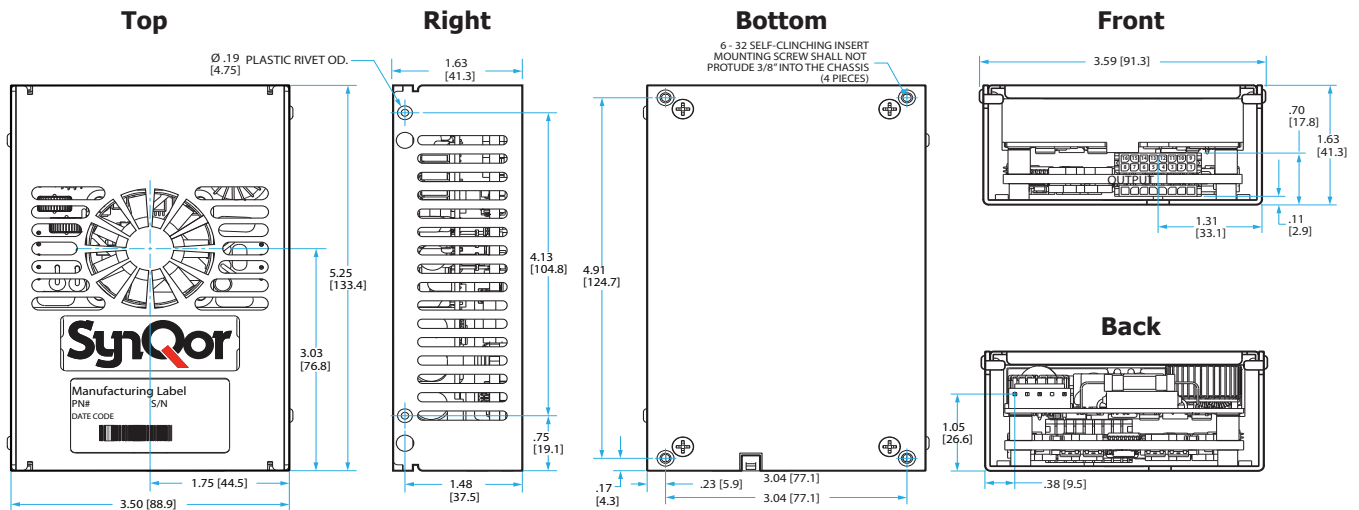

NOTES (applies to all mechanicals)

- 1) Recommended screw tightening torque of 6 in.lbs
- 2) Undimensioned components are shown for visual reference only
- 3) All dimensions in inches [mm]

Tolerances:
 x.xx in ± 0.02
 x.xxx in ± 0.010

MECHANICAL DRAWINGS

(2 Modules Flat Version - R Package Type)

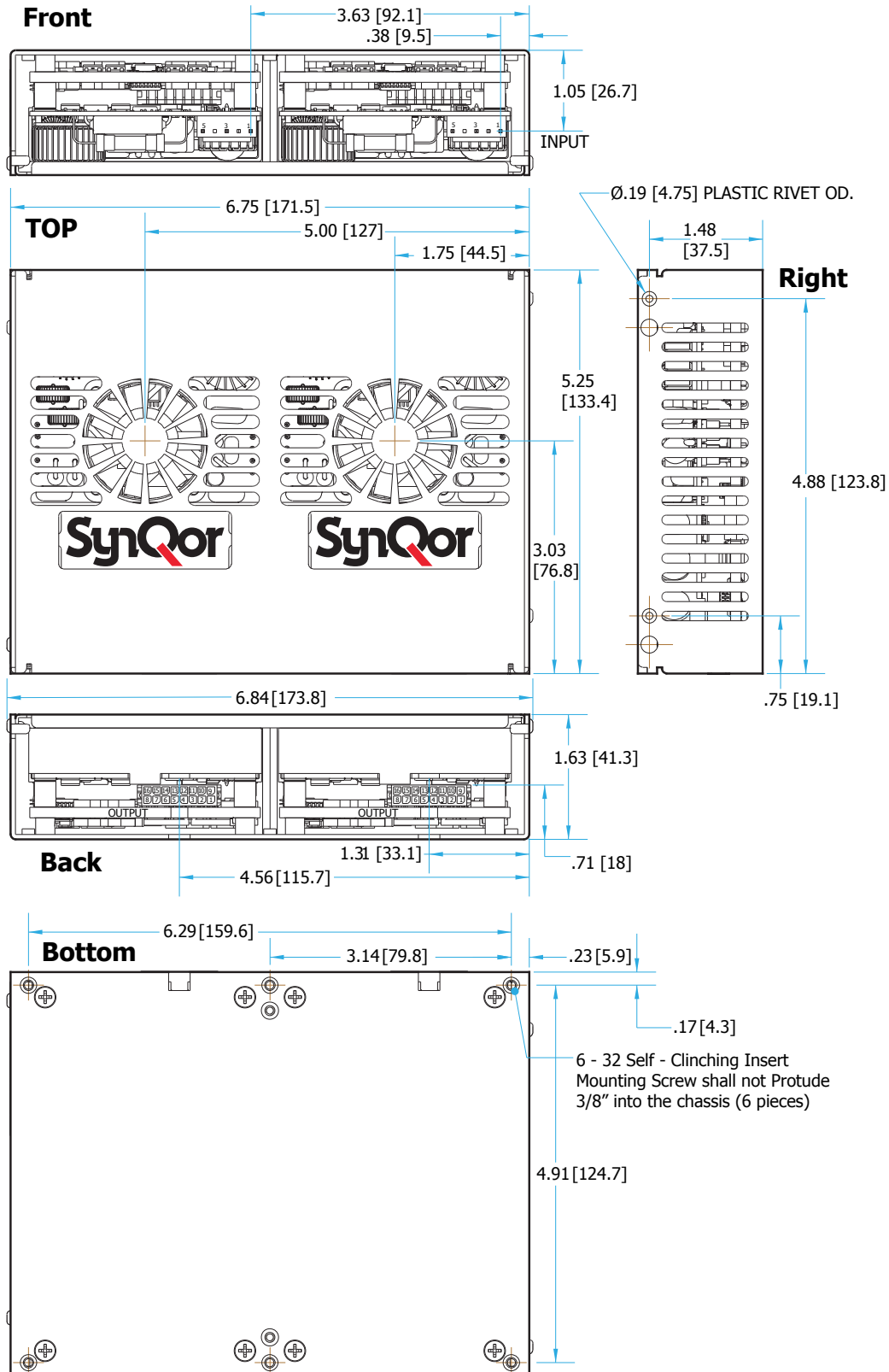

MECHANICAL DRAWINGS

(2 Modules Stacked Version - S Package Type)

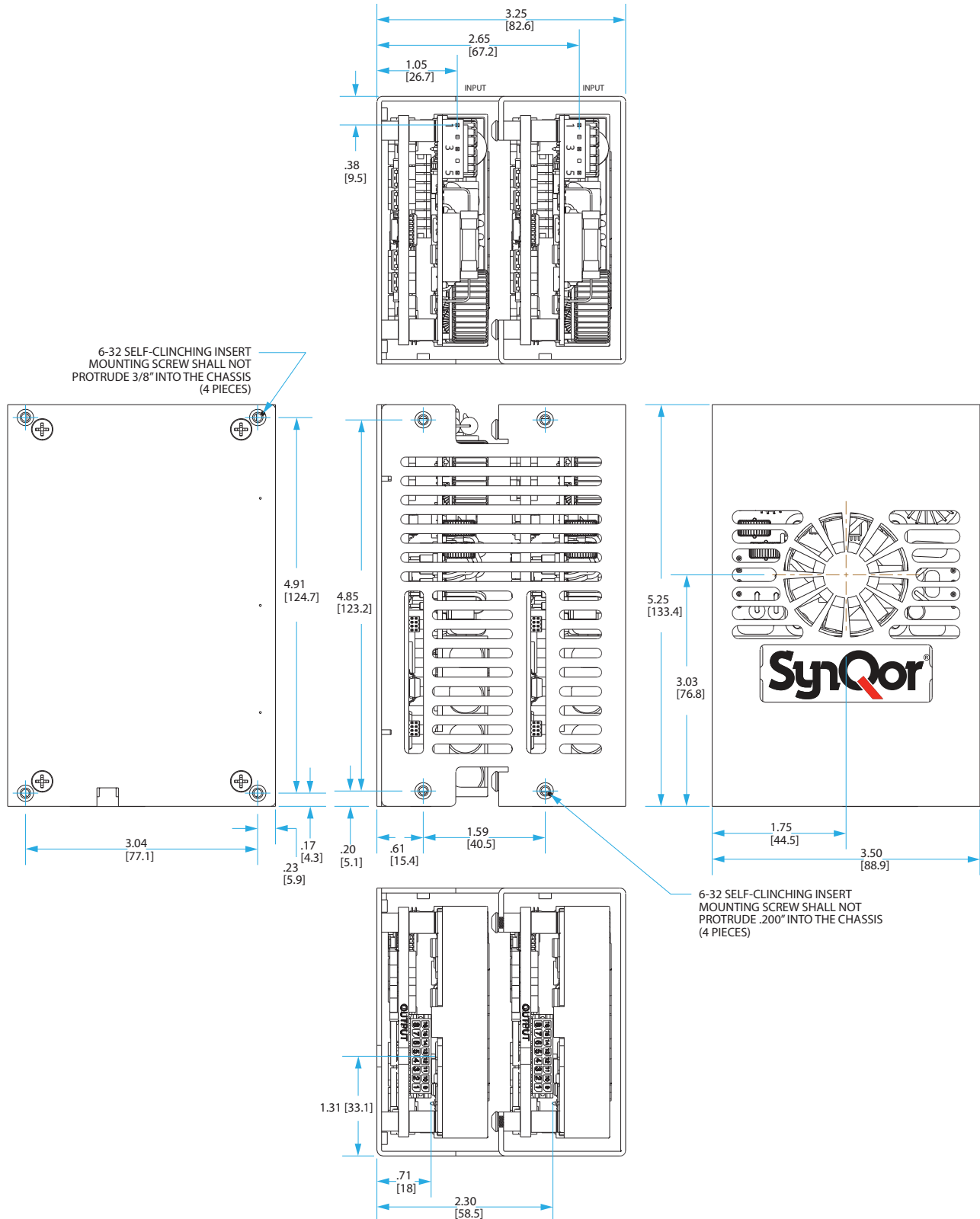



AC Input: 85-264 Vrms
DC Output: 12/24/36/48 V Semi-reg.
Power: 400 W
Grade: Industrial

Technical Specification

MECHANICAL DRAWINGS

(3 Modules Stacked Version - U Package Type)

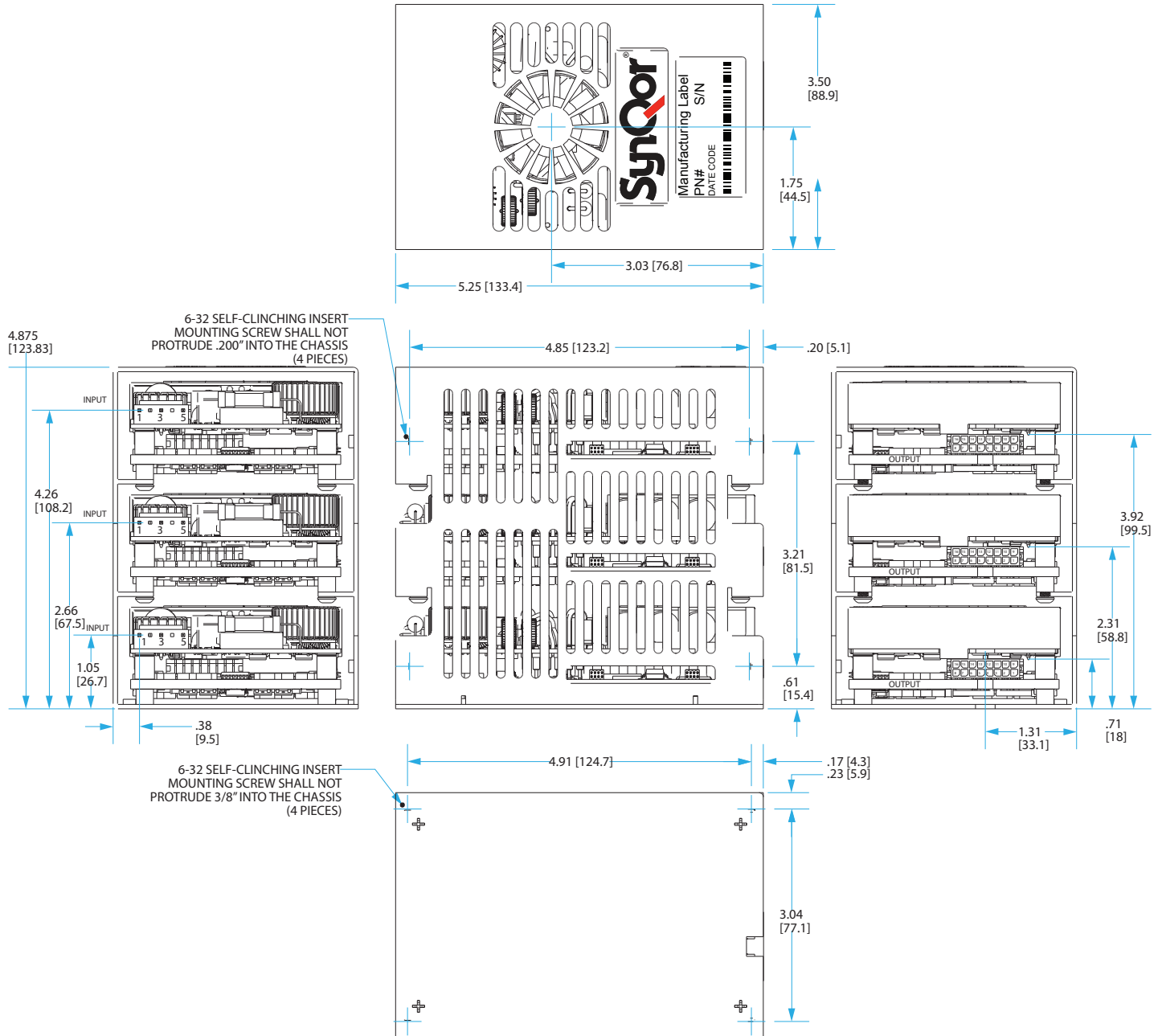

PARALLEL OPERATION - MULTIPLE UNITS

Chassis configurations for Parallel Units

ACuQor units are available either open-frame or pre-mounted at the factory. Up to 3 units can be mounted into a chassis, in either side-by-side or stacked configurations. For a complete list of options, see the "Part Numbering System" table on the last page, under "Package Type", along with the Mechanical Drawings pages. Only side-by-side configurations can be populated with 500W units, since each includes a thermal pad underneath.

Interconnection of Parallel Units

ACuQor units mounted in 2 and 3 unit chassis are not connected together. This allows the physical routing and connectivity of the external wiring to be customized to each application. The following table summarizes the recommended wiring to operate multiple units in parallel:

Specifications of Parallel Units

As a rule, units wired in parallel behave the same as single units. Any specification will remain unchanged that is expressed in units of voltage, time, frequency, or efficiency. Specifications expressed in terms of power, current, or capacitance, should be scaled by the number of units wired in parallel.

ACuQor units are individually calibrated at the factory, so that the output voltage vs. output current characteristic is always consistent (see Vout droop characteristic figures). As such, multiple units will share output current accurately. Full current is guaranteed from a bank of multiple units wired in parallel.

Output Connector Signal	Suggested Connection	Behavior with Multiple Units
REMOTE_ENABLE	Wire in parallel	Inputs activated simultaneously
FAN_GOOD	"	Wired-OR outputs – can be pulled low by any unit during an abnormal condition.
AC_POWER_GOOD	"	"
DC_POWER_GOOD	"	"
VOUT(+), VOUT(-)	"	Built-in droop characteristic ensures graceful current sharing.
12V_STANDBY*	"	"
5V_STANDBY	Do not wire in parallel	Fully regulated characteristic does not support current sharing. If placed in parallel, only the output with the highest set-point will drive current.

*Note: Triple output models only.

INSTALLATION INSTRUCTIONS

General: ACuQor AC/DC power supplies are intended for use as components in industrial equipment. ACuQor units must be properly installed within end use equipment before they can be safely applied as described in this document. The suitability of the ACuQor/equipment combination must be verified through end product investigation.

Mounting: Refer to the Mechanical Drawings section. ACuQor units are provided with threaded stainless-steel stand-offs or inserts for mounting. This mounting hardware is internally connected to the input connector protective-earth terminal for functional-earth EMC control. Any orientation (vertical, horizontal, etc.) may be used. Adequate air space should be provided over the fan intake (top) and exhaust (sides) to allow for exchange of cooling air. ACuQor is designed for a pollution degree 2 environment. The suitability of the enclosed ACuQor mechanical assemblies must be verified through end product investigation.

Encased models: A minimum of 5 mm electrical clearance should be allowed from the connector ends of encased models.

Input: Refer to the Connector Details section for input connector wiring. ACuQor products require a single phase AC power source of 100-240V 50/60Hz nominal. Refer to nameplate label for input current ratings. A protective-earth connection is also required. Minimum wire size of 18 AWG (0.8mm²) is recommended. Both sides of the AC line are internally fused (see table for specific models). These fuses are not user replaceable.

MODEL	Input Fuses (in Both AC Lines)	Fuses Total
AQ0300	Littelfuse 6.3A 250V 21606.3XEP	2
AQ0400	Littelfuse 6.3A 250V 21606.3XEP	2
AQ0500	Littelfuse 10.0A 250V 216010XEP	2

Output: Refer to the Connector Details section for output connector wiring and signal I/O functionality. Refer to nameplate label for output current ratings. Main DC output (Vout+, Vout-) pins should use 20 AWG (0.5mm²) wire size. Individual main output pins should not be loaded to more than 5.5 A. For currents greater than 5.5 A, multiple main output pins/wires must be used in parallel. All signal I/O pins are referenced to Vout-.

EMC: ACuQor products have been tested to the EMC specifications listed in the Electrical Characteristics section. However, end use equipment must be tested to verify EMC compliance.

Hipot Testing: ACuQor products are rated for Hipot testing levels of 1500 Vac input to protective-earth, 500 Vac output to protective-earth, and 3000 Vac input to output. When performing the 3000 Vac input to output test, the test voltage must be balanced evenly 1500 Vac input and output to protective-earth. Two oppositely phased test voltage sources or a single test voltage source with external balancing impedances (capacitors) may be used to prevent overstressing input or output to protective-earth insulation per IEC/ENC 60950-1.



Ordering Information

AC Input: 85-264 Vrms
DC Output: 12/24/36/48 V Semi-reg.
Power: 400 W
Grade: Industrial

PART NUMBERING SYSTEM

The part numbering system for SynQor's ACuQor AC/DC power supplies follows the format shown in the table below. Not all combinations make valid part numbers, please contact SynQor for availability.

Family	Output Power	Grade	Range	Output Voltage	Package Type	Thermal Design	Options
AQ: ACuQor series of AC-DC semi-regulated output power supplies	0300: 300 W 0400: 400 W 0500: 500 W 0600: 600 W (2 x 300 W) 0800: 800 W (2 x 400 W) 0900: 900 W (3 x 300 W) 1000: 1000 W (2 x 500 W) 1200: 1200 W (3 x 400 W) 1500: 1500 W (3 x 500 W)	I: (Industrial)	U: Universal (85-264 VRMS)	12: 12 V 1T: 12 V / 5 & 12 V STBY 24: 24 V 2T: 24 V / 5 & 12 V STBY 36: 36 V 3T: 36 V / 5 & 12 V STBY 48: 48 V 4T: 48 V / 5 & 12 V STBY	E: 1 unit (3"x5") R: 2 units; flat S: 2 units; stacked T: 3 units; flat U: 3 units; stacked	A: Open frame C: Encased	Industrial Grade: IND: Industrial

Example: AQ0400IU2TRCIND

ACCESSORIES

SynQor offers a series of assemblies that can be ordered according to the table below. Mechanical drawings for these accessories are available for download in pdf format from the SynQor website.

Part Number	Description
AQ-CBL-INPUT1C	Input mating cable with pre-stripped wire ends (36" long).
AQ-CBL-OUT1C	Output mating cables with pre-stripped wire ends (18" long).
AQ-CBL-OUT1CD	Same as AQ-CBL-OUT1C with an additional 8-pins connector.
AQ-CBL-OUT2C	Output mating cable with connectors on both ends (18" long).
AQ-CBL-OUT2CD	Same as the AQ-CBL-OUT2C with an additional 8-pins connector.
AQ-INSUL1M	Single module bottom-side Mylar insulator for open frame mounting
AQ-EVAL-PRL3	Evaluation board for up to three paralleled modules.

APPLICATION NOTES

A variety of application notes and technical white papers can be downloaded in pdf format from the SynQor website.

[Online Application Notes](#)

[Online Library of Technical White Papers](#)

[SynQor website.](#)

Contact SynQor for further information and to order:

Phone: 978-849-0600
Toll Free: 888-567-9596
Fax: 978-849-0602
E-mail: power@synqor.com
Web: www.synqor.com
Address: 155 Swanson Road
 Boxborough, MA 01719
 USA

PATENTS

SynQor holds numerous U.S. patents, one or more of which apply to most of its power converter products. Any that apply to the product(s) listed in this document are identified by markings on the product(s) or on internal components of the product(s) in accordance with U.S. patent laws. SynQor's patents include the following:

5,999,417	6,222,742	6,545,890	6,594,159	6,731,520	6,894,468
6,896,526	6,927,987	7,050,309	7,072,190	7,085,146	7,119,524
7,269,034	7,272,021	7,272,023	7,558,083	7,564,702	7,765,687
7,787,261	8,023,290	8,149,597	8,493,751	8,644,027	

WARRANTY

SynQor offers a two (2) year limited warranty. Complete warranty information is listed on our website or is available upon request from SynQor.