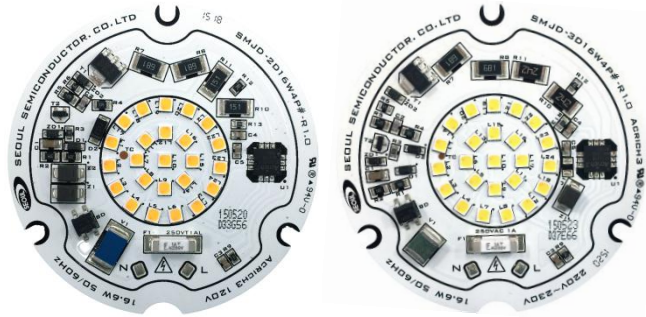

Integrated AC LED Solution

**Acrich3 – 16.6W**
**SMJD-XD16W4PX**

## Product Brief

### Description

- The Acrich3 series of products are designed to be driven directly off of AC line voltage, therefore they do not need the standard converter essential for conventional general lighting products.
- The converter or driver found in most general lighting products can limit the overall life of the product, but with the Acrich3 series of products the life of the product can more closely be estimated from the LED itself. This will also allow for a much smaller form factor from an overall fixture design allowing for higher creativity in the fixture.
- The modules have a high power factor which can contribute to a higher energy savings in the end application.

### Features and Benefits

- Connects directly to AC line voltage
- High Power Efficiency & Factor
- Low THD
- Long Life Time
- Simple BOM
- Miniaturization
- Lead Free Product
- RoHS Compliant
- TRIAC Dimming

### Key Applications

- Down Light

**Table 1. Product Selection (CCT)**

Part No.	Vin [Vac]	P [W]	Color	CCT [K]	CRI
					Min.
SMJD-2D16W4PD SMJD-3D16W4PD	120 220	16.6	Cool	4700 – 6000	80
SMJD-2D16W4PE SMJD-3D16W4PE	120 220				Warm

**Table 2. Product Selection (Flux)**

Part No.	Vin [Vac]	P [W]	Flux [lm]		Remark
			Min.	Typ.	
SMJD-2D16W4PD SMJD-3D16W4PD	120 220	16.6	1350	1450	16a
			1450	1600	16b
			1600	1750	16c
SMJD-2D16W4PE SMJD-3D16W4PE	120 220	16.6	1250	1350	16a

---

## Table of Contents

Index	
• Product Brief	1
• Table of Contents	2
• Performance Characteristics	3
• Thermal Resistance	5
• Characteristic Graph	6
• Color Bin Structure	11
• Mechanical Dimensions	17
• Marking Information	19
• Packing Information	20
• Label Information	21
• Handling of Silicone Resin for LEDs	22
• Precaution for Use	23
• Company Information	25

---

## Performance Characteristics

**Table 3. Electro Optical Characteristics, T<sub>a</sub> = 25°C**

Parameter	Symbol	Value			Unit	Mark
		Min.	Typ.	Max.		
Luminous Flux (@CRI.80)	$\Phi_V$ <sup>[2]</sup>	1350	1450	-	lm	16a
		1450	1600	-		16b
		1600	1750	-		16c
Luminous Flux (@CRI.90)		1250	1350	-		16a
Correlated Color Temperature <sup>[3]</sup>	CCT	5300	5600	6000	K	B
		4700	5000	5300		C
		3700	4000	4200		E
		2900	3000	3200		G
		2600	2700	2900		H
CRI	Ra	80	-	-	-	PD
		90	-	-	-	PE
Input Voltage <sup>[4]</sup>	V <sub>in</sub>	120			Vac	2D
		220				3D
Power Consumption	P	14.9	16.6	18.3	W	16W
Operating Frequency	F	50 / 60			Hz	
Power Factor	PF	Over 0.97			-	
Viewing Angle	2 $\Theta_{1/2}$	120			deg.	
Tolerance of Surge <sup>[5]</sup>	V <sub>s</sub>	500	-	-	V	
Transient Protection <sup>[6]</sup>	V <sub>s</sub>	2500	-	-	V	

**Notes :**

- (1) At 120/220Vac, T<sub>a</sub> = 25°C
- (2)  $\Phi_V$  is the total luminous flux output measured with an integrated sphere.
- (3) Correlated Color Temperature is derived from the CIE 1931 Chromaticity diagram.
- (4) Operating Voltage doesn't indicate the maximum voltage which customers use but means tolerable voltage according to each country's voltage variation rate. It is recommended that the solder pad temperature should be below 70 °C.
- (5) Surge withstand in accordance with IEC61000-4-5
- (6) At 120Vac, seven strikes, 100kHz 2.5kV in accordance with ANSI/IEEE C62.41.2-2002 Category A operation

## Performance Characteristics

**Table 4. Absolute Maximum Ratings,  $T_a = 25^\circ\text{C}$** 

Parameter	Symbol	Unit	Value
Maximum Input Voltage @120Vac	$V_{in}$	Vac	144
Maximum Input Voltage @220Vac			264
Power Consumption	P	W	21.5
Operating Temperature	$T_{opr}$	$^\circ\text{C}$	-30 ~ 85
Storage Temperature	$T_{stg}$	$^\circ\text{C}$	-40 ~ 100
ESD Sensitivity	-	-	$\pm 4,000\text{V HBM}$

## Thermal Resistance

**Table 5. Thermal information, Ta = 25°C**

Part	Maximum Junction Temperature [°C]	R $\theta_{j-s}$ [°C/W]
Acrich3 LED	125	9
Acrich3 IC	150	11.25

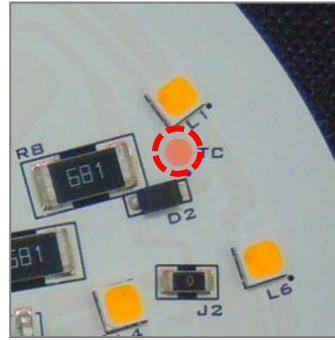
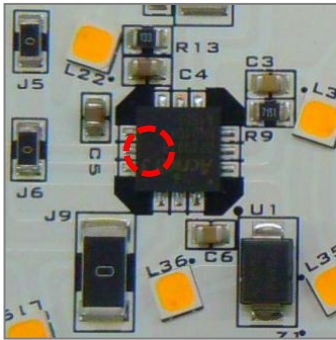
**Notes :**

The Acrich3 module is recommended to keep the junction temperature under maximum junction temperature spec. (Table 5)

LED lead temperature and IC top case temperature are measured with thermocupler. (Fig1)

LED & IC junction temperatures can be calculated using the formulas below.

$$T_{s\_max} = T_{j\_max} - (R\theta_{j-s} * P_d)$$

< Example >

If LED lead temperature and IC top temperature are 110 °C

1) LED junction temperature

$$\begin{aligned} T_J &= T_S + (R\theta_{j-s} * P_d) \\ &= 110\text{ °C} + (9\text{ °C/W} * 0.84\text{W}) = 117.56\text{ °C} \end{aligned}$$

2) IC junction temperature

$$\begin{aligned} T_J &= T_S + (R\theta_{j-s} * P_d)^{(1)} \\ &= 110\text{ °C} + (11.25\text{ °C/W} * 2.8\text{W}) = 141.5\text{ °C} \end{aligned}$$

\* (1) : In the example, P<sub>d</sub> value is the power consumption of IC when the rated voltage.

## Characteristics Graph

Fig 1. Relative Spectral Distribution vs. Wavelength Characteristic – G, H

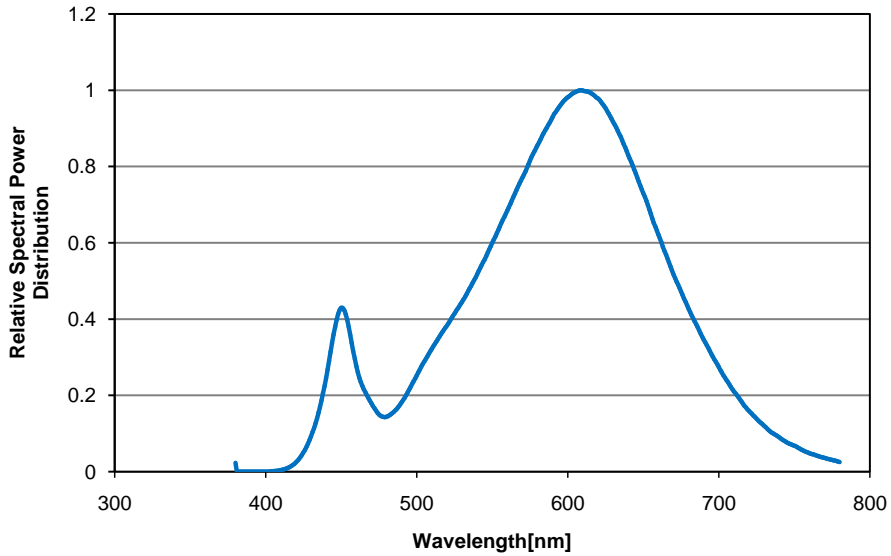
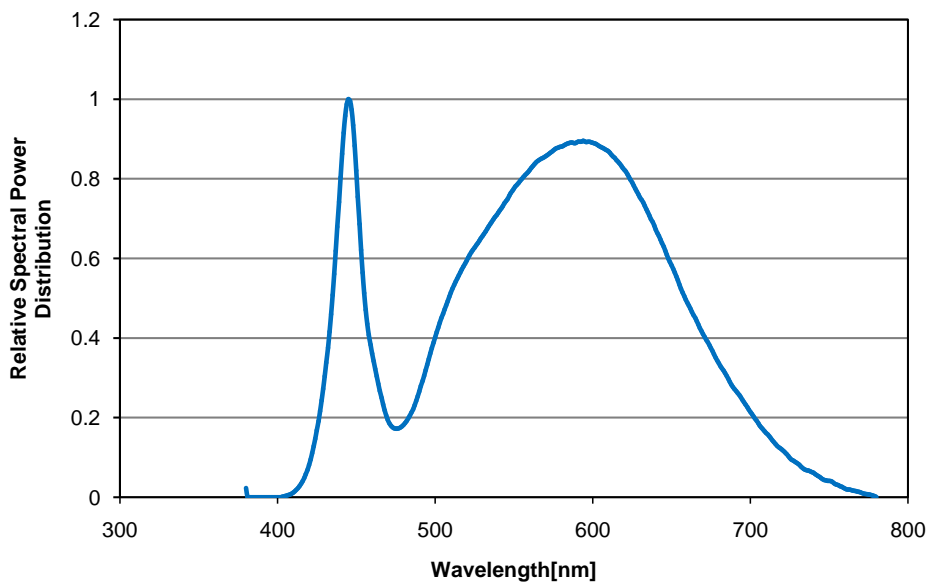
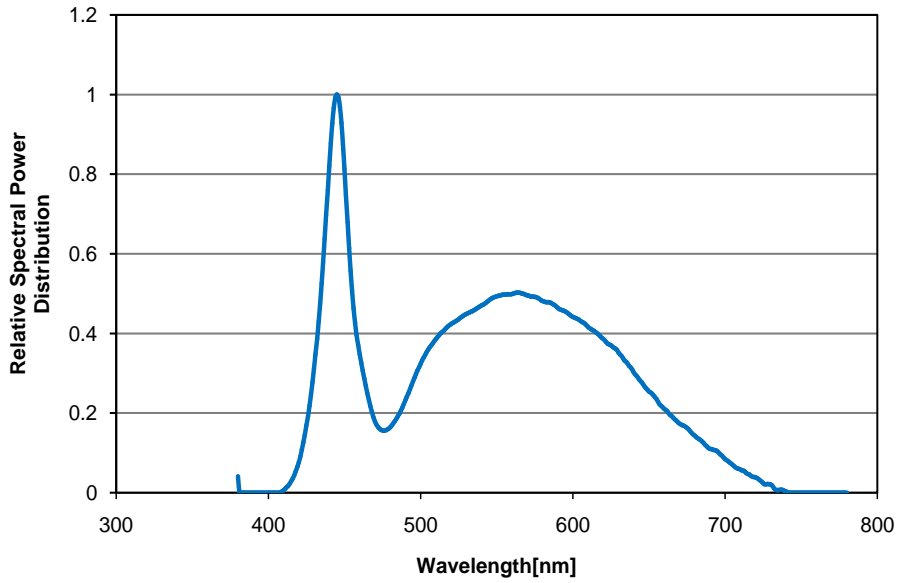

Fig 2. Relative Spectral Distribution vs. Wavelength Characteristic – E



## Characteristics Graph

Fig 3. Relative Spectral Distribution vs. Wavelength Characteristic – B,C



## Characteristics Graph

Fig 4. Relative Power Distribution vs. Voltage at  $T_a=25^{\circ}\text{C}$ , 120V

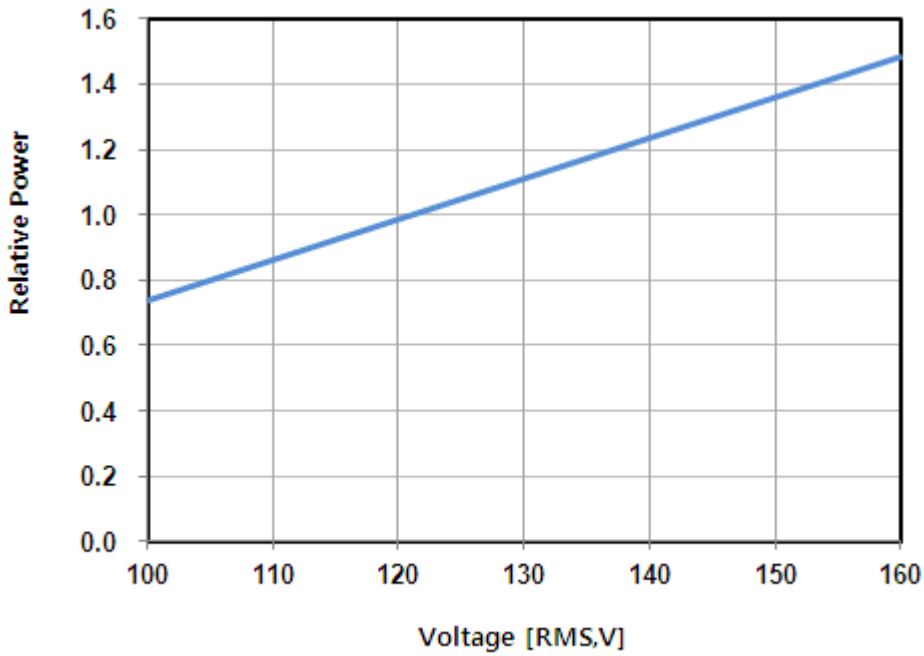
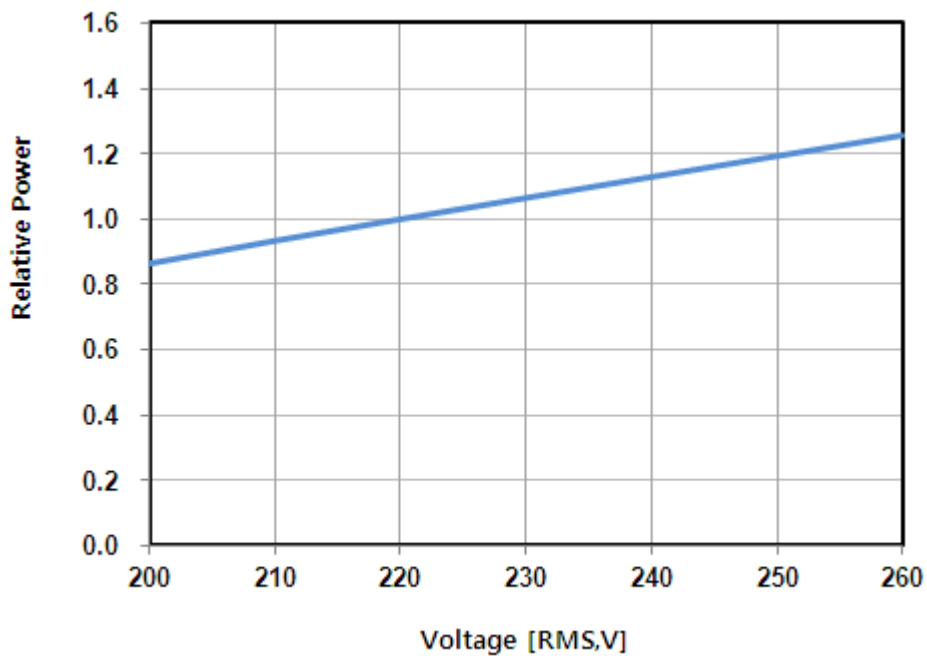

Fig 5. Relative Power Distribution vs. Voltage at  $T_a=25^{\circ}\text{C}$ , 220V





## Characteristics Graph

Fig 6. Relative Luminous Flux vs. Voltage at  $T_a=25^{\circ}\text{C}$ , 220V

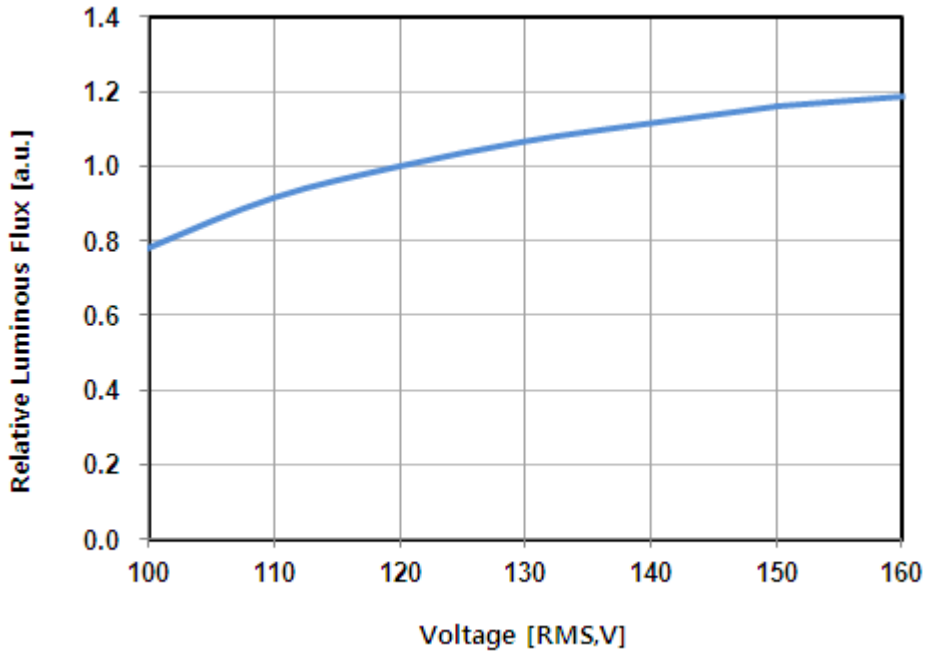
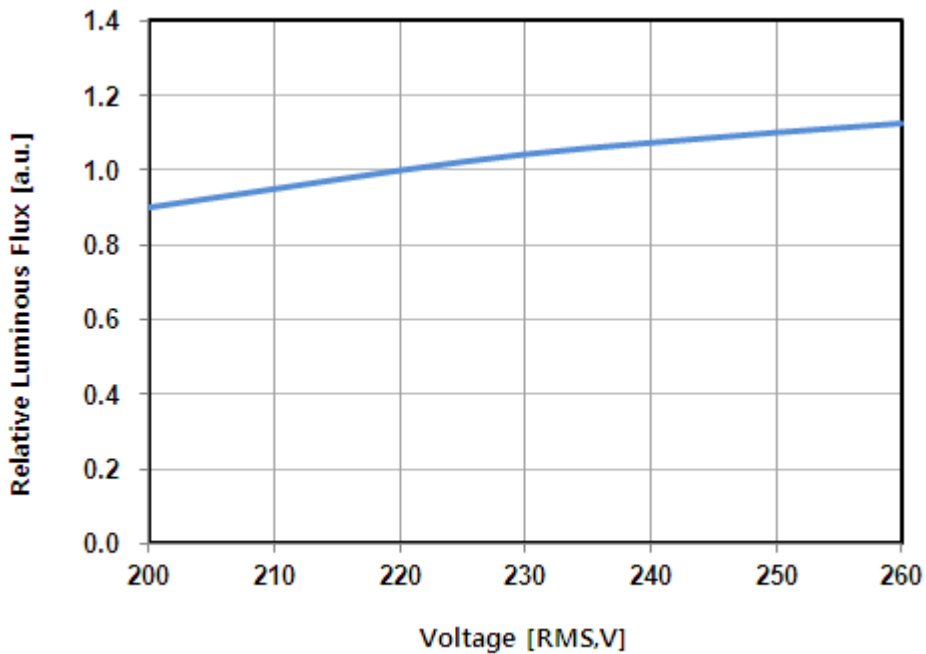
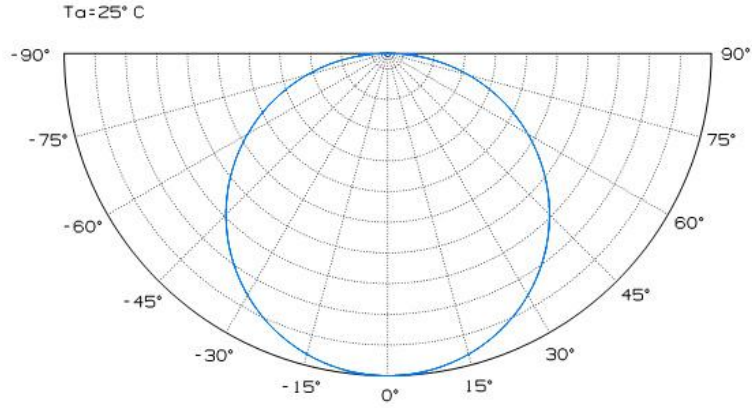

Fig 7. Relative Luminous Flux vs. Voltage at  $T_a=25^{\circ}\text{C}$ , 220V



## Characteristics Graph

Fig 8. Radiant Pattern,  $T_a = 25^\circ\text{C}$



## Color Bin Structure

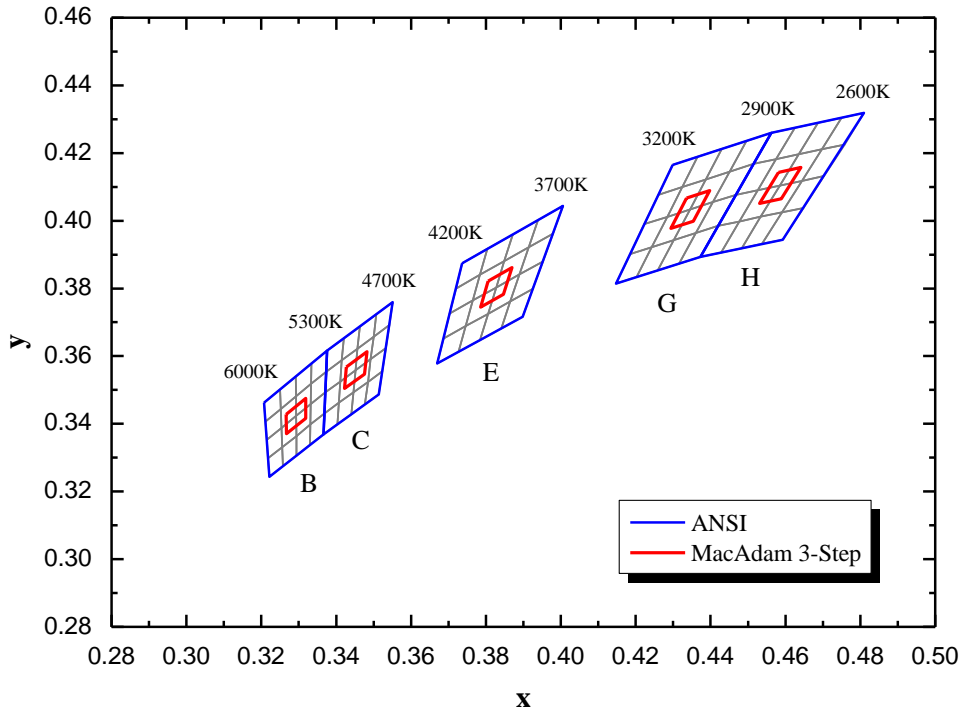

Bin	x	y	Bin	x	y	Bin	x	y
<b>BM</b>	0.3266	0.3428	<b>CM</b>	0.3427	0.3568	<b>EM</b>	0.3806	0.3822
	0.3268	0.3371		0.3423	0.3504		0.3786	0.3745
	0.3319	0.3416		0.3476	0.3547		0.3846	0.3782
	0.3319	0.3476		0.3482	0.3613		0.3870	0.3861
<b>GM</b>	0.4336	0.4067	<b>HM</b>	0.4581	0.4143			
	0.4294	0.3977		0.4531	0.4051			
	0.4354	0.3999		0.4589	0.4065			
	0.4398	0.4089		0.4641	0.4157			

## Color Bin Structure

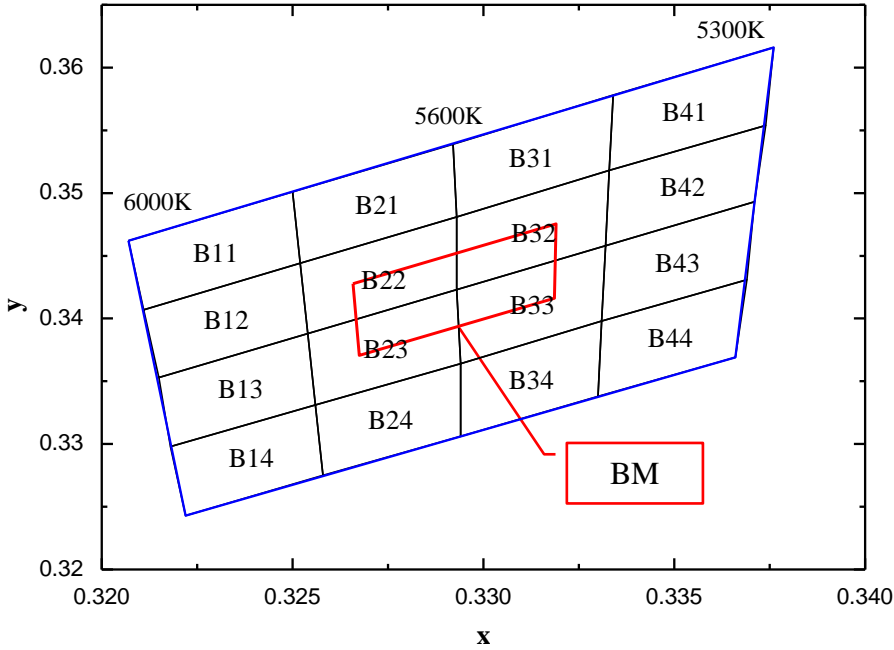

Bin	x	y	Bin	x	y	Bin	x	y	Bin	x	y
B11	0.3207	0.3462	B21	0.3250	0.3501	B31	0.3292	0.3539	B41	0.3334	0.3578
	0.3211	0.3407		0.3252	0.3444		0.3293	0.3481		0.3333	0.3518
	0.3252	0.3444		0.3293	0.3481		0.3333	0.3518		0.3374	0.3554
	0.3250	0.3501		0.3292	0.3539		0.3334	0.3578		0.3376	0.3616
B12	0.3211	0.3407	B22	0.3252	0.3444	B32	0.3293	0.3481	B42	0.3333	0.3518
	0.3215	0.3353		0.3254	0.3388		0.3293	0.3423		0.3332	0.3458
	0.3254	0.3388		0.3293	0.3423		0.3332	0.3458		0.3371	0.3493
	0.3252	0.3444		0.3293	0.3481		0.3333	0.3518		0.3374	0.3554
B13	0.3215	0.3353	B23	0.3254	0.3388	B33	0.3293	0.3423	B43	0.3332	0.3458
	0.3218	0.3298		0.3256	0.3331		0.3294	0.3364		0.3331	0.3398
	0.3256	0.3331		0.3294	0.3364		0.3331	0.3398		0.3369	0.3431
	0.3254	0.3388		0.3293	0.3423		0.3332	0.3458		0.3371	0.3493
B14	0.3218	0.3298	B24	0.3256	0.3331	B34	0.3294	0.3364	B44	0.3331	0.3398
	0.3222	0.3243		0.3258	0.3275		0.3294	0.3306		0.3330	0.3338
	0.3258	0.3275		0.3294	0.3306		0.3330	0.3338		0.3366	0.3369
	0.3256	0.3331		0.3294	0.3364		0.3331	0.3398		0.3369	0.3431

## Color Bin Structure

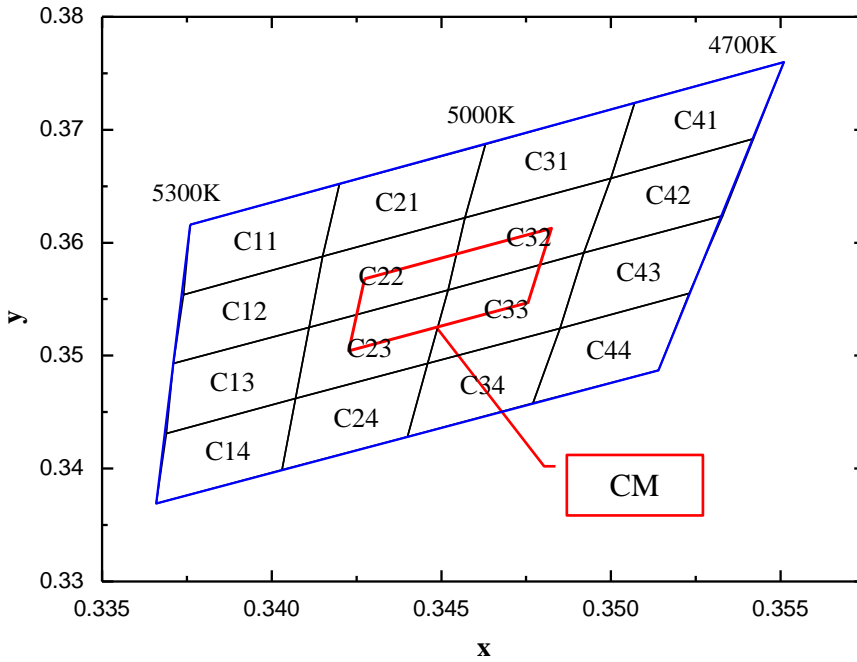

Bin	x	y	Bin	x	y	Bin	x	y	Bin	x	y
C11	0.3376	0.3616	C21	0.3420	0.3652	C31	0.3463	0.3687	C41	0.3507	0.3724
	0.3374	0.3554		0.3415	0.3588		0.3457	0.3622		0.3500	0.3657
	0.3415	0.3588		0.3457	0.3622		0.3500	0.3657		0.3542	0.3692
	0.3420	0.3652		0.3463	0.3687		0.3507	0.3724		0.3551	0.3760
C12	0.3374	0.3554	C22	0.3415	0.3588	C32	0.3457	0.3622	C42	0.3500	0.3657
	0.3371	0.3493		0.3411	0.3525		0.3452	0.3558		0.3492	0.3591
	0.3411	0.3525		0.3452	0.3558		0.3492	0.3591		0.3533	0.3624
	0.3415	0.3588		0.3457	0.3622		0.3500	0.3657		0.3542	0.3692
C13	0.3371	0.3493	C23	0.3411	0.3525	C33	0.3452	0.3558	C43	0.3492	0.3591
	0.3369	0.3431		0.3407	0.3462		0.3446	0.3493		0.3485	0.3524
	0.3407	0.3462		0.3446	0.3493		0.3485	0.3524		0.3523	0.3555
	0.3411	0.3525		0.3452	0.3558		0.3492	0.3591		0.3533	0.3624
C14	0.3369	0.3431	C24	0.3407	0.3462	C34	0.3446	0.3493	C44	0.3485	0.3524
	0.3366	0.3369		0.3403	0.3399		0.3440	0.3428		0.3477	0.3458
	0.3403	0.3399		0.3440	0.3428		0.3477	0.3458		0.3514	0.3487
	0.3407	0.3462		0.3446	0.3493		0.3485	0.3524		0.3523	0.3555

## Color Bin Structure

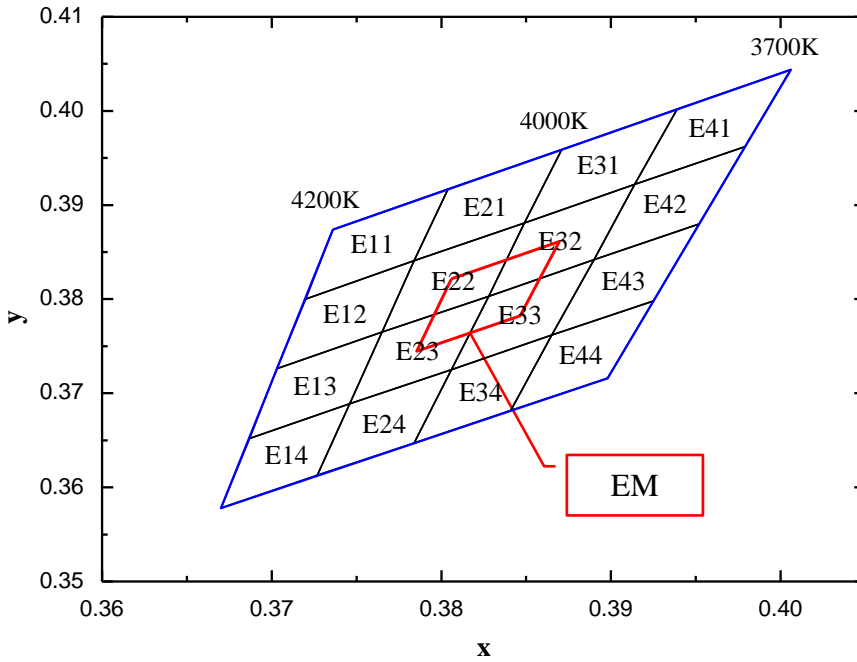

Bin	x	y	Bin	x	y	Bin	x	y	Bin	x	y
E11	0.3736	0.3874	E21	0.3804	0.3917	E31	0.3871	0.3959	E41	0.3939	0.4002
	0.3720	0.3800		0.3784	0.3841		0.3849	0.3881		0.3914	0.3922
	0.3784	0.3841		0.3849	0.3881		0.3914	0.3922		0.3979	0.3962
	0.3804	0.3917		0.3871	0.3959		0.3939	0.4002		0.4006	0.4044
E12	0.3720	0.3800	E22	0.3784	0.3841	E32	0.3849	0.3881	E42	0.3914	0.3922
	0.3703	0.3726		0.3765	0.3765		0.3828	0.3803		0.3890	0.3842
	0.3765	0.3765		0.3828	0.3803		0.3890	0.3842		0.3952	0.3880
	0.3784	0.3841		0.3849	0.3881		0.3914	0.3922		0.3979	0.3962
E13	0.3703	0.3726	E23	0.3765	0.3765	E33	0.3828	0.3803	E43	0.3890	0.3842
	0.3687	0.3652		0.3746	0.3689		0.3806	0.3725		0.3865	0.3762
	0.3746	0.3689		0.3806	0.3725		0.3865	0.3762		0.3925	0.3798
	0.3765	0.3765		0.3828	0.3803		0.3890	0.3842		0.3952	0.3880
E14	0.3687	0.3652	E24	0.3746	0.3689	E34	0.3806	0.3725	E44	0.3865	0.3762
	0.3670	0.3578		0.3727	0.3613		0.3784	0.3647		0.3841	0.3682
	0.3727	0.3613		0.3784	0.3647		0.3841	0.3682		0.3898	0.3716
	0.3746	0.3689		0.3806	0.3725		0.3865	0.3762		0.3925	0.3798

## Color Bin Structure

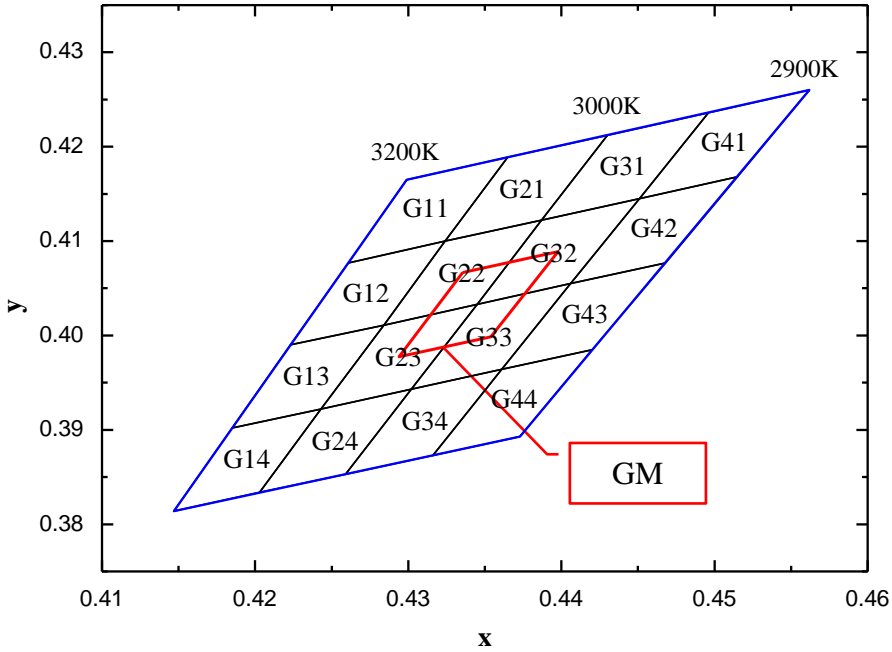

Bin	x	y	Bin	x	y	Bin	x	y	Bin	x	y
<b>G11</b>	0.4299	0.4165	<b>G21</b>	0.4364	0.4188	<b>G31</b>	0.4430	0.4212	<b>G41</b>	0.4496	0.4236
	0.4261	0.4077		0.4324	0.4099		0.4387	0.4122		0.4451	0.4145
	0.4324	0.4100		0.4387	0.4122		0.4451	0.4145		0.4514	0.4168
	0.4365	0.4189		0.4430	0.4212		0.4496	0.4236		0.4562	0.4260
<b>G12</b>	0.4261	0.4077	<b>G22</b>	0.4324	0.4100	<b>G32</b>	0.4387	0.4122	<b>G42</b>	0.4451	0.4145
	0.4223	0.3990		0.4284	0.4011		0.4345	0.4033		0.4406	0.4055
	0.4284	0.4011		0.4345	0.4033		0.4406	0.4055		0.4468	0.4077
	0.4324	0.4100		0.4387	0.4122		0.4451	0.4145		0.4515	0.4168
<b>G13</b>	0.4223	0.3990	<b>G23</b>	0.4284	0.4011	<b>G33</b>	0.4345	0.4033	<b>G43</b>	0.4406	0.4055
	0.4185	0.3902		0.4243	0.3922		0.4302	0.3943		0.4361	0.3964
	0.4243	0.3922		0.4302	0.3943		0.4361	0.3964		0.4420	0.3985
	0.4284	0.4011		0.4345	0.4033		0.4406	0.4055		0.4468	0.4077
<b>G14</b>	0.4243	0.3922	<b>G24</b>	0.4302	0.3943	<b>G34</b>	0.4302	0.3943	<b>G44</b>	0.4361	0.3964
	0.4203	0.3834		0.4259	0.3853		0.4259	0.3853		0.4316	0.3873
	0.4147	0.3814		0.4203	0.3834		0.4316	0.3873		0.4373	0.3893
	0.4185	0.3902		0.4243	0.3922		0.4361	0.3964		0.4420	0.3985

## Color Bin Structure

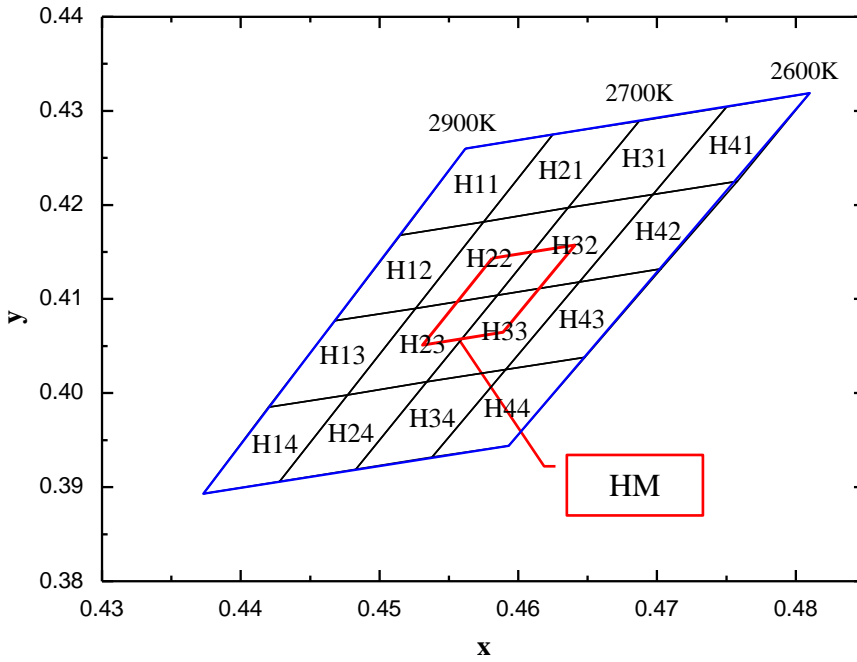

Bin	x	y	Bin	x	y	Bin	x	y	Bin	x	y
H11	0.4562	0.4260	H21	0.4625	0.4275	H31	0.4687	0.4289	H41	0.4750	0.4304
	0.4515	0.4168		0.4575	0.4182		0.4636	0.4197		0.4697	0.4211
	0.4575	0.4182		0.4636	0.4197		0.4697	0.4211		0.4758	0.4225
	0.4625	0.4275		0.4687	0.4289		0.4750	0.4304		0.4810	0.4319
H12	0.4515	0.4168	H22	0.4575	0.4182	H32	0.4636	0.4197	H42	0.4697	0.4211
	0.4468	0.4077		0.4526	0.4090		0.4585	0.4104		0.4644	0.4118
	0.4526	0.4090		0.4585	0.4104		0.4644	0.4118		0.4703	0.4132
	0.4575	0.4182		0.4636	0.4197		0.4697	0.4211		0.4758	0.4225
H13	0.4468	0.4077	H23	0.4526	0.4090	H33	0.4585	0.4104	H43	0.4644	0.4118
	0.4420	0.3985		0.4477	0.3998		0.4534	0.4012		0.4591	0.4025
	0.4477	0.3998		0.4534	0.4012		0.4591	0.4025		0.4648	0.4038
	0.4526	0.4090		0.4585	0.4104		0.4644	0.4118		0.4703	0.4132
H14	0.4420	0.3985	H24	0.4477	0.3998	H34	0.4534	0.4012	H44	0.4591	0.4025
	0.4373	0.3893		0.4428	0.3906		0.4483	0.3919		0.4538	0.3932
	0.4428	0.3906		0.4483	0.3919		0.4538	0.3932		0.4593	0.3944
	0.4477	0.3998		0.4534	0.4012		0.4591	0.4025		0.4648	0.4038



## Mechanical Dimensions

SMJD-2D16W4PD  
SMJD-2D16W4PE

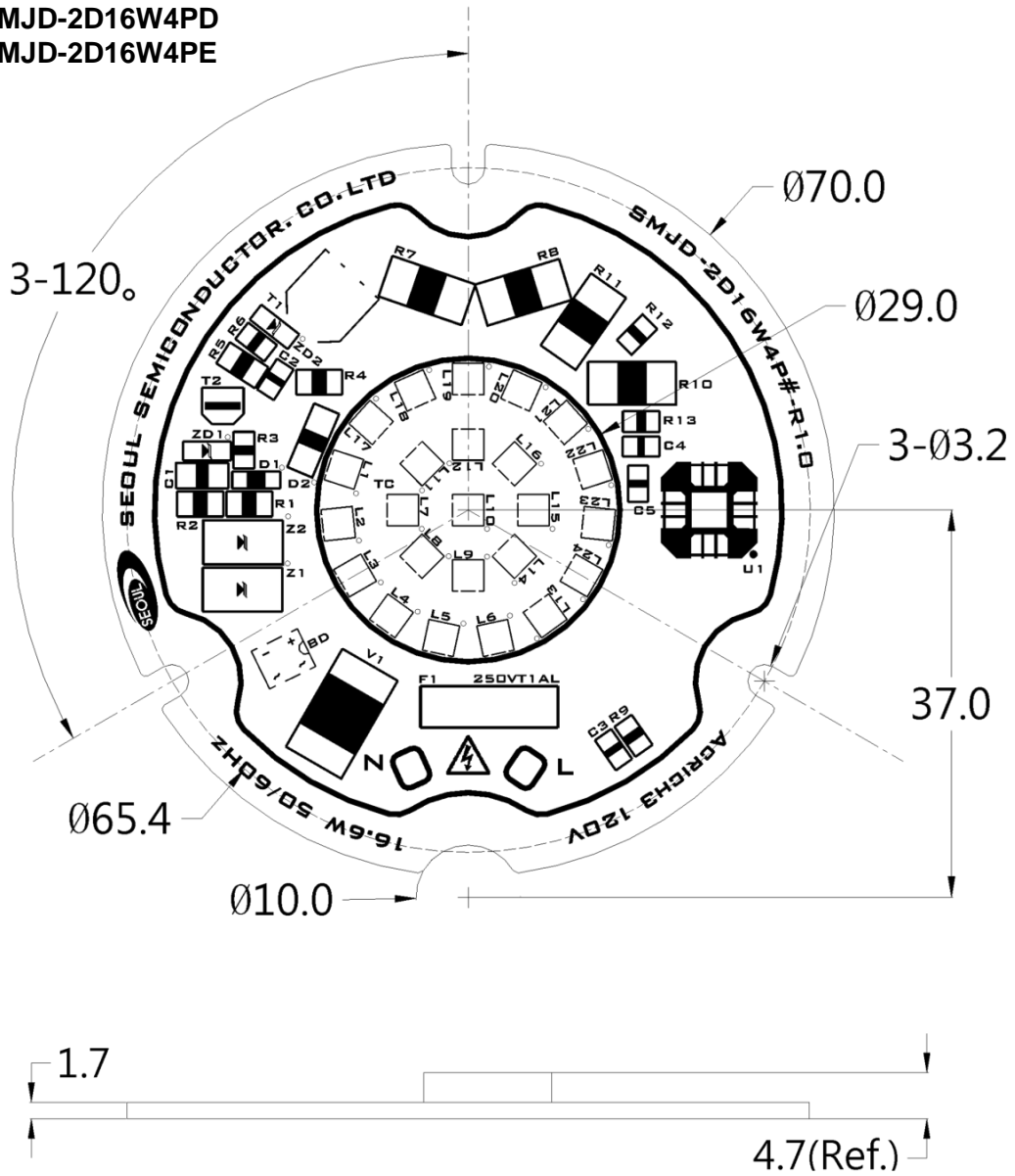

**Notes :**

- (1) All dimensions are in millimeters. (Tolerance : ±0.2)
- (2) Scale : None

## Mechanical Dimensions

SMJD-3D16W4PD  
SMJD-3D16W4PE

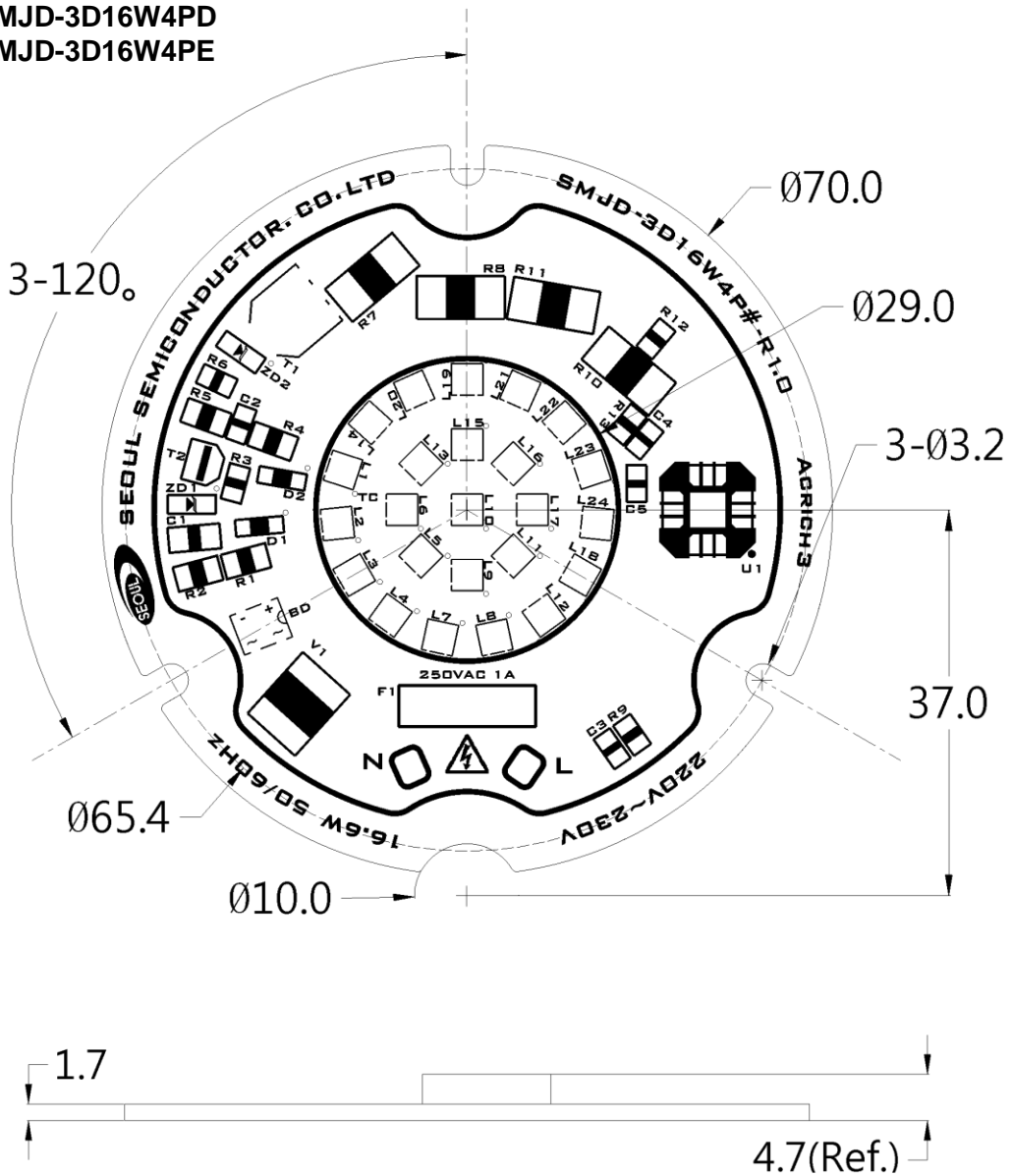

**Notes :**

- (1) All dimensions are in millimeters. (Tolerance : ±0.2)
- (2) Scale : None

# Marking Information

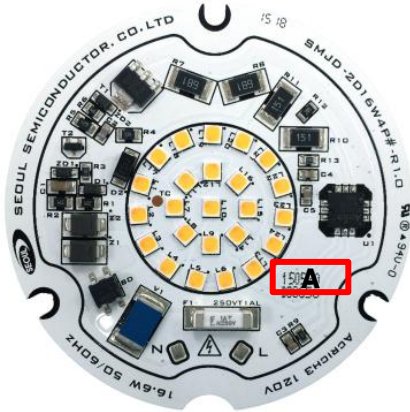

A : ex) 150101 DbZG11

- Description

- ① SMT Date (YYMMDD, 6 Digits)
- ② CRI (1 Digits)
- ③ Module Flux Bin (3 Digits)
- ④ CCT (1 Digit)
- ⑤ CCT Combination NO. (1 Digit)
- ⑥ VF Combination NO. (1 Digit)

150101

①

D b L 3 G 1 1

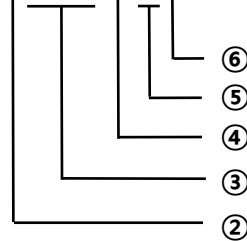

A : Marking

② CRI		③ Module Flux Bin			④ CCT			⑥ VF Bin				
Mark	CRI	Type	Mark	Min.	Typ.	Mark	Bin A	Bin B	Mark	Min.	Max.	
D	80	a	88	1250	1350	*0	*22	*33	1	D1	D1	
E	90		99			*1	*23	*32	2	D1	D2	
		b	11	1350	1450	*2	*33	*22	3	D2	D1	
			33	1450	1600	*3	*32	*23	4	D1	D3	
			55			*4	*MC	*MC	5	D3	D1	
			c	77	1600	1750	*5	*22	*22	6	D2	D2
				*6	*23	*23	7	D2	D3			
				*7	*32	*32	8	D3	D2			
				*8	*33	*33	9	D3	D3			
		*9	*22	*34								
		*A	*22	*43								
		*B	*22	*44								
		*C	*23	*31								
		*D	*23	*41								
		*E	*23	*42								
		*F	*32	*13								
		*G	*32	*14								
		*H	*32	*24								
		*I	*33	*11								
		*J	*33	*12								
		*K	*33	*21								

\* CCT Mark from \*0 to \*4 is 3-step

## Packing

### 1. Tray information

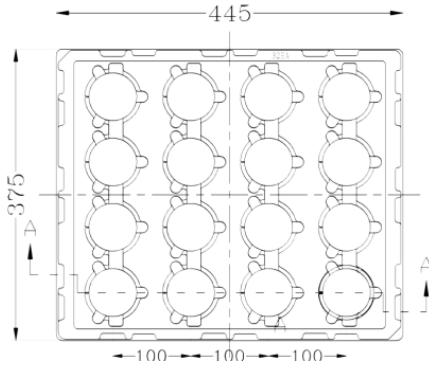

- 20 PCS LED modules packed per tray

### 2. Tray stack and taping

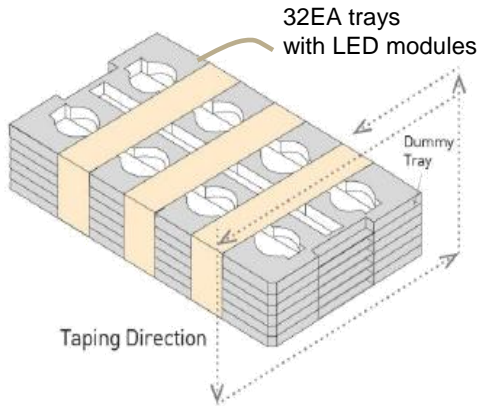

- 10 LED module trays and additional 1 dummy trays each up and down of box
- Add silica gel (1EA) on top of the tray

### 3. Sealing packing

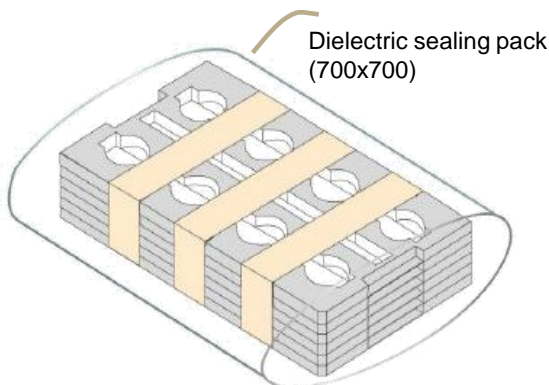

### 4. Box information & packing

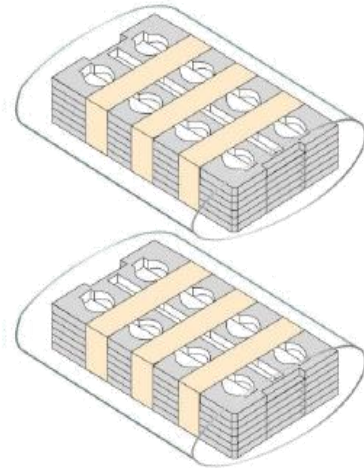



- Box Size : 590 x 330 x 165 mm
- 320 PCS modules per BOX 1EA
- \*\* 1 Box : 32 PCS per tray x 10 trays = 320 PCS

## Label Information

<b>Model No.</b>	<b>SMJD-XD16W4PX (1)</b> 
<b>Rank</b>	<b>16bG803 (2)</b> 
<b>Type</b>	<b>3-step(3)</b>
<b>Quantity</b>	<b>XX</b> 
<b>Date</b>	<b>YYMDDXXXXX-XXXXXXX</b> 
	<b>SEOUL SEMICONDUCTOR CO.,LTD.</b>

**Notes**

- (1) The model number designation is explained as follow  
 SMJD : Seoul Semiconductor internal code  
 XD : Input Voltage (2D = 120V, 3D = 220V)  
 16W : About Power Consumption  
 4 : Acrich IC Version 3.0  
 PX: MJT PKG (D=SAW8C72A, E=SAW9C72A)
- (2) It represents Module Optical SPEC.  
 Luminous flux : 16a, 16b, 16c  
 CCT : H-B  
 CRI : 80 or 90  
 CIE Area : 3 or 4(3step or 4step)
- (3) It represents module CIE SPEC  
 CIE Area : 3step or 4step
- (4) It is attached to the top of a sealing pack & the bottom right corner of the box.

<b>TOTAL Quantity</b>  <b>XX</b>
 <b>SEOUL SEMICONDUCTOR CO.,LTD.</b>

**Notes**

- (1) It is attached to the bottom right corner of the box.

## Handling of Silicone Resin for LEDs

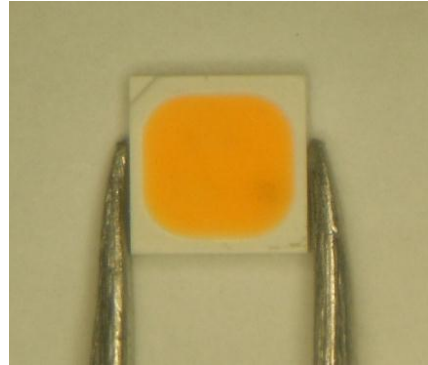
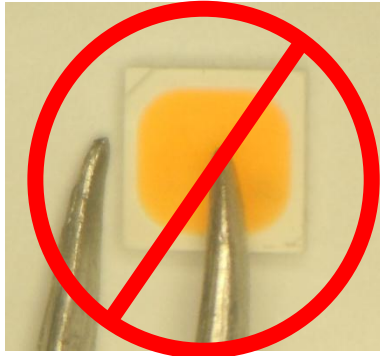

- (1) Acrich3 series is encapsulated with silicone resin for high optical efficiency.
- (2) Please do not touch the silicone resin area with sharp objects such as pincette(tweezers).
- (3) Finger prints on silicone resin area may affect the performance.
- (4) Please store LEDs in covered containers to prevent dust accumulation as this may affect performance.
- (5) Excessive force more than 3000gf to the silicone lens can result in fatal or permanent damage with LEDs.
- (6) Please do not cover the silicone resin area with any other resins such as epoxy, urethane, etc.

## Precaution for Use

- (1) Please review the Acrich3 Application Note for proper protective circuitry usage.
- (2) Please note, Acrich3 products run off of high voltage, therefore caution should be taken when working near Acrich3 products.
- (3) Make sure proper discharge prior to starting work.
- (4) DO NOT touch any of the circuit board, components or terminals with body or metal while circuit is active.
- (5) Please do not add or change wires while Acrich3 circuit is active.
- (6) Long time exposure to sunlight or UV can cause the lens to discolor.
- (7) Please do not use adhesives to attach the LED that outgas organic vapor.
- (8) Please do not use together with the materials containing Sulfur.
- (9) Please do not assemble in conditions of high moisture and/or oxidizing gas such as Cl, H<sub>2</sub>S, NH<sub>3</sub>, SO<sub>2</sub>, NO<sub>x</sub>, etc.
- (10) Please do not make any modification on module.
- (11) Please be cautious when soldering to board so as not to create a short between different trace patterns.
- (12) Do not impact or place pressure on this product because even a small amount of pressure can damage the product. The product should also not be placed in high temperatures, high humidity or direct sunlight since the device is sensitive to these conditions.
- (13) When storing devices for a long period of time before usage, please following these guidelines:
  - \* The devices should be stored in the anti-static bag that it was shipped in from Seoul-Semiconductor with opening.
  - \* If the anti-static bag has been opened, re-seal preventing air and moisture from being present in the bag.
- (14) LEDs and IC are sensitive to Electro-Static Discharge (ESD) and Electrical Over Stress (EOS). The acrich3 product should also not be installed in end equipment without ESD protection. Below is a list of suggestions that Seoul Semiconductor purposes to minimize these effects.

### a. ESD (Electro Static Discharge)

Electrostatic discharge (ESD) is the defined as the release of static electricity when two objects come into contact. While most ESD events are considered harmless, it can be an expensive problem in many industrial environments during production and storage. The damage from ESD to an LEDs may cause the product to demonstrate unusual characteristics such as:

## Precaution for Use

- Increase in reverse leakage current lowered turn-on voltage
- Abnormal emissions from the LED at low current

The following recommendations are suggested to help minimize the potential for an ESD event. One or more recommended work area suggestions:

- Ionizing fan setup
- ESD table/shelf mat made of conductive materials
- ESD safe storage containers

One or more personnel suggestion options:

- Antistatic wrist-strap
- Antistatic material shoes
- Antistatic clothes

Environmental controls:

- Humidity control (ESD gets worse in a dry environment)

### b. EOS (Electrical Over Stress)

Electrical Over-Stress (EOS) is defined as damage that may occur when an electronic device is subjected to a current or voltage that is beyond the maximum specification limits of the device. The effects from an EOS event can be noticed through product performance like:

- Changes to the performance of the LED package  
(If the damage is around the bond pad area and since the package is completely encapsulated the package may turn on but flicker show severe performance degradation.)
- Changes to the light output of the luminaire from component failure
- Components on the board not operating at determined drive power

Failure of performance from entire fixture due to changes in circuit voltage and current across total circuit causing trickle down failures. It is impossible to predict the failure mode of every LED exposed to electrical overstress as the failure modes have been investigated to vary, but there are some common signs that will indicate an EOS event has occurred:

- Damaged may be noticed to the bond wires (appearing similar to a blown fuse)
- Damage to the bond pads located on the emission surface of the LED package  
(shadowing can be noticed around the bond pads while viewing through a microscope)
- Anomalies noticed in the encapsulation and phosphor around the bond wires
- This damage usually appears due to the thermal stress produced during the EOS event

c. To help minimize the damage from an EOS event Seoul Semiconductor recommends utilizing:

- A surge protection circuit
- An appropriately rated over voltage protection device
- A current limiting device





## Company Information

### Published by

Seoul Semiconductor © 2013 All Rights Reserved.

### Company Information

Seoul Semiconductor ([www.SeoulSemicon.com](http://www.SeoulSemicon.com)) manufactures and packages a wide selection of light emitting diodes (LEDs) for the automotive, general illumination/lighting, Home appliance, signage and back lighting markets. The company is the world's fifth largest LED supplier, holding more than 10,000 patents globally, while offering a wide range of LED technology and production capacity in areas such as "nPola", "Acrich", the world's first commercially produced AC LED, and "Acrich MJT - Multi-Junction Technology" a proprietary family of high-voltage LEDs.

The company's broad product portfolio includes a wide array of package and device choices such as Acrich and Acirch2, high-brightness LEDs, mid-power LEDs, side-view LEDs, and through-hole type LEDs as well as custom modules, displays, and sensors.

### Legal Disclaimer

Information in this document is provided in connection with Seoul Semiconductor products. With respect to any examples or hints given herein, any typical values stated herein and/or any information regarding the application of the device, Seoul Semiconductor hereby disclaims any and all warranties and liabilities of any kind, including without limitation, warranties of non-infringement of intellectual property rights of any third party. The appearance and specifications of the product can be changed to improve the quality and/or performance without notice.