

AP



RoHS Compliant

Subminiature Pushbutton Switches



■ Features

1. Gold-plated contacts.
2. Terminal pin pitch: 2.54 mm.

■ Specifications

Rating	Max:50mA 48VAC/DC Min:1μA 20mVAC/DC
Initial contact resistance	50m Ωmax. (1.5mA 200μVAC)
Dielectric strength	500VAC 1 minute
Insulation resistance	10,000MΩ min. (250VDC)
Electrical life	10,000 operations at maximum rating. 50,000 operations at 0.4VA.
Operating temperature range	-20~+85°C
Storage temperature range	-40~+85°C

■ Part Numbering

A P 2 L - 2 M - Z

Series code Actuator shape Number of poles Switching function Terminal style Actuator shape

Code	Type
P	Non-washable type

Fig.	Number of poles
1	1 pole
2	2 poles

Code	Switching function
B L	ON — (OFF)
C M	OFF — (ON)
F R	ON — (ON)

Fig.	Terminal style
2	P/C terminal
6	Right angle (0.3 inch pitch)

Code	Actuator shape
M	Standard
S	Short
H	Square

■ Actuator Shape

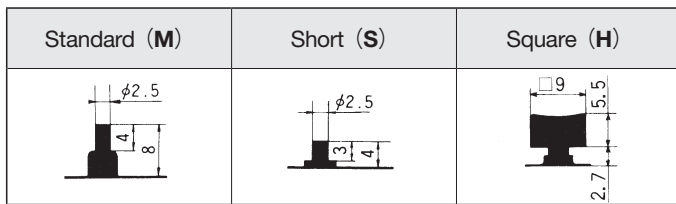

■ PC Hole Layouts.....Page 249.

■ Right angle Terminals

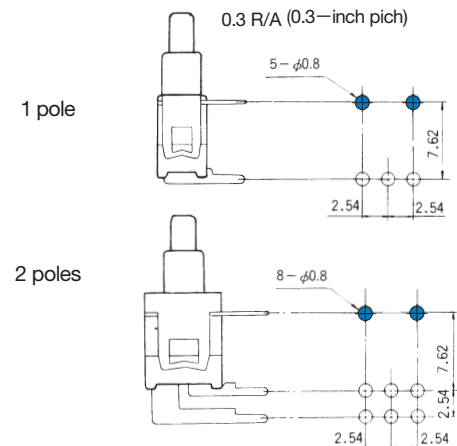

AP-M (Standard type)

SPST/SPDT

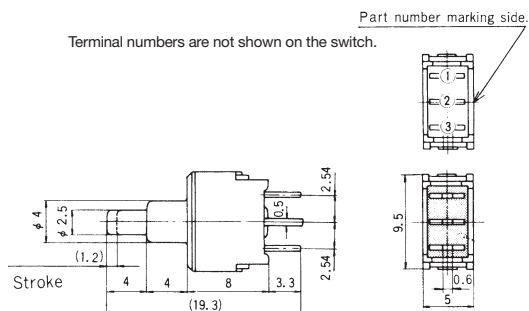
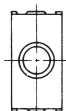

※ Terminal pin No.2 is not available in switches with Switching Function "B" and "C".

PC

Switching function		Push
Part No.		
★※AP1B-2M-Z	ON	(OFF)
Connecting terminals	1-3	-
※AP1C-2M-Z	OFF	(ON)
Connecting terminals	-	1-3
☆ AP1F-2M-Z	ON	(ON)
Connecting terminals	2-3	2-1

DPST/DPDT

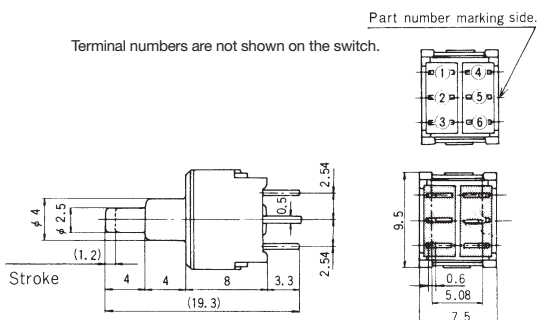
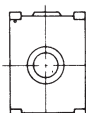

※ Terminal pins No.2 and 5 are not available in switches with Switching Function "L" and "M".

PC

Switching function		Push
Part No.		
★※AP2L-2M-Z	ON	(OFF)
Connecting terminals	1-3 4-6	-
★※AP2M-2M-Z	OFF	(ON)
Connecting terminals	-	1-3 4-6
★ AP2R-2M-Z	ON	(ON)
Connecting terminals	2-3 5-6	2-1 5-4

SPST/SPDT

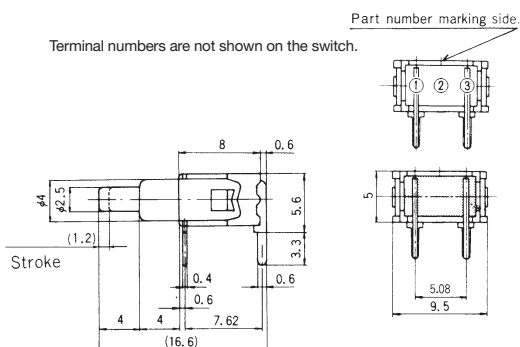
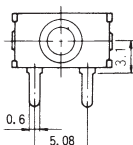
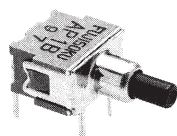

※ Terminal pin No.2 is not available in switches with Switching Function "B" and "C".

0.3R/A

Switching function		Push
Part No.		
★※AP1B-6M-Z	ON	(OFF)
Connecting terminals	1-3	-
※AP1C-6M-Z	OFF	(ON)
Connecting terminals	-	1-3
★※AP1F-6M-Z	ON	(ON)
Connecting terminals	2-3	2-1

DPST/DPDT

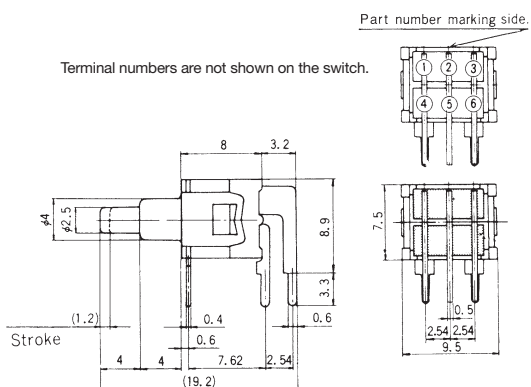
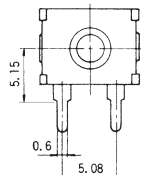
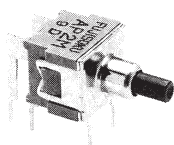

※ Terminal pins No.2 and 5 are not available in switches with Switching Function "L" and "M".

0.3R/A

Switching function		Push
Part No.		
★※AP2L-6M-Z	ON	(OFF)
Connecting terminals	1-3 4-6	-
☆※AP2M-6M-Z	OFF	(ON)
Connecting terminals	-	1-3 4-6
★ AP2R-6M-Z	ON	(ON)
Connecting terminals	2-3 5-6	2-1 5-4

(ON). (OFF) : Momentary.

☆ : Semi-standard products. ★ : Made to order products.

AP-S (Short type)

SPST/SPDT

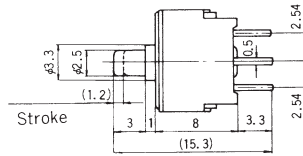

Part number marking side.

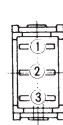

Terminal numbers are not shown on the switch.

Switching function		
Part No.		
★※AP1B-2S-Z	ON	(OFF)
Connecting terminals	1-3	-
※AP1C-2S-Z	OFF	(ON)
Connecting terminals	-	1-3
AP1F-2S-Z	ON	(ON)
Connecting terminals	2-3	2-1

PC

※ Terminal pin No.2 is not available in switches with Switching Function "B" and "C".

DPST/DPDT

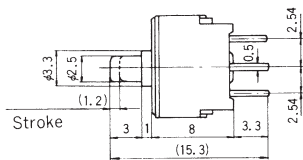
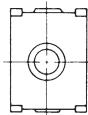

Part number marking side.

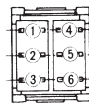

Terminal numbers are not shown on the switch.

Switching function		
Part No.		
★※AP2L-2S-Z	ON	(OFF)
Connecting terminals	1-3 4-6	-
★※AP2M-2S-Z	OFF	(ON)
Connecting terminals	-	1-3 4-6
★ AP2R-2S-Z	ON	(ON)
Connecting terminals	2-3 5-6	2-1 5-4

PC

※ Terminal pins No.2 and 5 are not available in switches with Switching Function "L" and "M".

SPST/SPDT

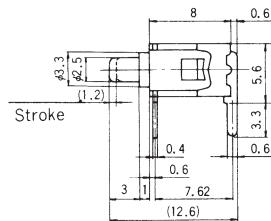
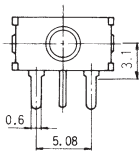
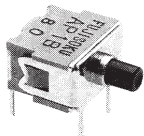

Part number marking side.

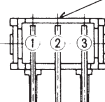

Terminal numbers are not shown on the switch.

Switching function		
Part No.		
★※AP1B-6S-Z	ON	(OFF)
Connecting terminals	1-3	-
※AP1C-6S-Z	OFF	(ON)
Connecting terminals	-	1-3
AP1F-6S-Z	ON	(ON)
Connecting terminals	2-3	2-1

0.3R/A

※ Terminal pin No.2 is not available in switches with Switching Function "B" and "C".

DPST/DPDT

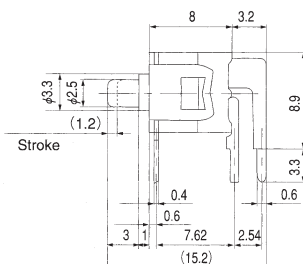
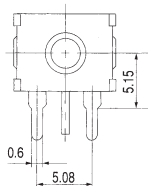

Type number making side.

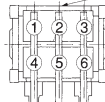

Terminal numbers are not shown on the switch.

Switching function		
Part No.		
★※AP2L-6S-Z	ON	(OFF)
Connecting terminals	1-3 4-6	-
★※AP2M-6S-Z	OFF	(ON)
Connecting terminals	-	1-3 4-6
☆ AP2R-6S-Z	ON	(ON)
Connecting terminals	2-3 5-6	2-1 5-4

0.3R/A

※ Terminal pins No.2 and 5 are not available in switches with Switching Function "L" and "M".

AP-H (Square type)

SPST/SPDT

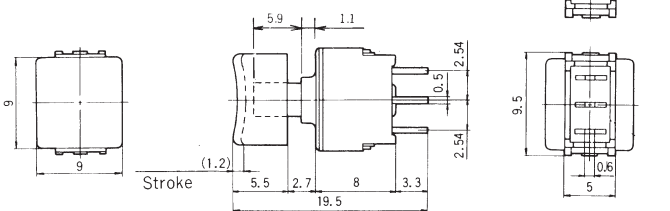
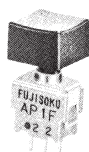

PC

※ Terminal pin No.2 is not available in switches with Switching Function "B" and "C".

Switching function		Push
Part No.		
★※AP1B-2H-Z	ON	(OFF)
Connecting terminals	1-3	-
※AP1C-2H-Z	OFF	(ON)
Connecting terminals	-	1-3
AP1F-2H-Z	ON	(ON)
Connecting terminals	2-3	2-1

DPST/DPDT

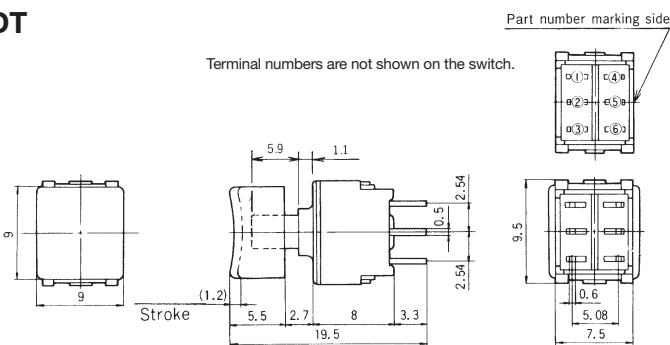

PC

※ Terminal pins No.2 and 5 are not available in switches with Switching Function "L" and "M".

Switching function		Push
Part No.		
▲※AP2L-2H-Z	ON	(OFF)
Connecting terminals	1-3 4-6	-
★※AP2M-2H-Z	OFF	(ON)
Connecting terminals	-	1-3 4-6
★ AP2R-2H-Z	ON	(ON)
Connecting terminals	2-3 5-6	2-1 5-4

Standard Accessories

《Sold separately》

Color Button for AP-H series		
Dimensions	Color	Part No.
<p>ABS resin</p>	White	140000470198
	Red	140000470200
	Black	140000470199
	Gray	140000470204
	Green	140000470202
	Blue	140000470203
	Orange	140000470205
	Yellow	140000470201
	Brown	140000470206

A Color Button is supplied with the switch. Please select from the above 9 part numbers.

Optional Accessories (10pcs / pack)

(AP·APE)

《Sold separately》

Color Cap for AP-M, APE-M & AP-S series		
Dimensions	Color	Part No.
<p>PC resin</p>	White	140000481402
	Red	140000481404
	Black	140000481403
	Gray	140000481408
	Green	140000481406
	Blue	140000481407
	Orange	140000481414
	Yellow	140000481405
	Brown	140000481409

Optional Accessories (AP · APE)

《Sold separately》

Part name	Bracket				
	Single pole		Double poles		
Poles	Single pole		Double poles		
Box size	5 mm	5 mm	7.5 mm	7.5 mm	5 mm
Type	AP-M·APE-M·AP-H	AP-S	AP-M·AP-H·APE-M	AP-S	APE-M
Dimensions					
Part No.	140000640314	140000640316	140000640315	140000640317	140000640318

(ON). (OFF) : Momentary.

: Optional Accessories.

★ : Made to order products.

■ Soldering Specifications

- (1) Manual Soldering
 - Device : Soldering iron
 - ① 380°C, Max.; 3 seconds, Max.
- (2) Auto Soldering (PC types only)
 - Device : Jet wave type or dip type
 - ① 275°C, 6 seconds, Max.
 - Pre-heating should be done at temperatures from 80 to 120° C and within 120 seconds.
- (3) When soldering two or more terminals to the common land, use solder resist to solder them independently.

■ Flux Cleaning

- (1) Solvent : Fluorine or Alcohol type
- (2) The **AP** series are not washable. To wash the PC board, clean the soldering surface of the PC board with a brush so that the switch is not exposed to the cleaning solution.

■ Packaging Specifications

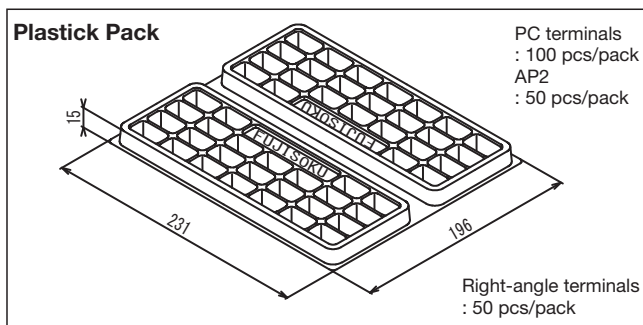

■ Color Cap Mounting

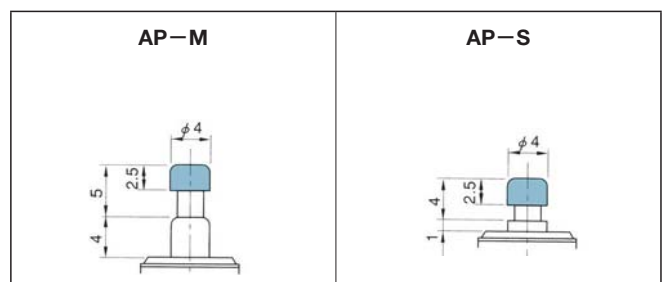

Refer to P.253.

■ Table of Part Numbers

Term.style	Poles	Switching function	APE-M	AP-M	AP-S	AP-H
PC	1 pole	ON - (OFF)	—	★AP1B-2M-Z	★AP1B-2S-Z	★AP1B-2H-Z
		OFF - (ON)	—	AP1C-2M-Z	AP1C-2S-Z	AP1C-2H-Z
		ON - (ON)	APE1F-2M-10-Z	☆AP1F-2M-Z	AP1F-2S-Z	AP1F-2H-Z
	2 poles	ON - (OFF)	—	★AP2L-2M-Z	▲AP2L-2S-Z	▲AP2L-2H-Z
		OFF - (ON)	—	★AP2M-2M-Z	★AP2M-2S-Z	★AP2M-2H-Z
		ON - (ON)	APE2F-2M-10-Z	★AP2R-2M-Z	★AP2R-2S-Z	★AP2R-2H-Z
0.3R/A	1 pole	ON - (OFF)	—	★AP1B-6M-Z	★AP1B-6S-Z	—
		OFF - (ON)	—	AP1C-6M-Z	AP1C-6S-Z	—
		ON - (ON)	APE1F-6M-10-Z	★AP1F-6M-Z	AP1F-6S-Z	—
	2 poles	ON - (OFF)	—	★AP2L-6M-Z	★AP2L-6S-Z	—
		OFF - (ON)	—	☆AP2M-6M-Z	★AP2M-6S-Z	—
		ON - (ON)	☆APE2F-6M-10-Z	★AP2R-6M-Z	☆AP2R-6S-Z	—
0.2R/A	1 pole	ON - (ON)	APE1F-5M-10-Z	—	—	—
		ON - (ON)	APE1F-5M-10-2-Z	—	—	—
	2 poles	ON - (ON)	★APE2F-5M-10-Z	—	—	—