

AOD-P1

OD Max

DISPLACEMENT MEASUREMENT SENSORS

SICK
Sensor Intelligence.

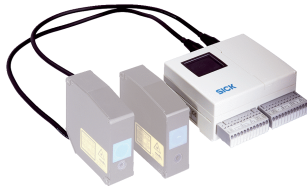

Ordering information

Type	Part no.
AOD-P1	6028960

Other models and accessories → www.sick.com/OD_Max



Detailed technical data

Features

System part	Amplifier unit
--------------------	----------------

Performance

Response time	0.5 ms ¹⁾
Measuring frequency	10 kHz
Output time	≤ 0.1 ms
Additional function	Arithmetic calculations, Mean-value setting 1 ... 4,096x, Frequency filters, automatic sensitivity adjustment, manual sensitivity adjustment, Time functions, 8 memory banks, Hold functions, Peak-to-peak measurement, Peak height measurement, Bottom measurement, Analog outputs can be taught in, Switching outputs can be taught in, set hysteresis, Internal data recorder, switching mode: distance to object (DtO), switching mode: window (Wnd)
Note	Required for OD350-x, OD85-x, OD30-x

¹⁾ Automatic sensitivity adjustment ≤ 2 ms.

Interfaces

Analog output	2 x -5 ... +5 V (≥ 1 kΩ) ¹⁾ 2 x 4 mA ... 20 mA (≤ 300 Ω) ¹⁾
Resolution analog output	16 bit
Switching output	5 x PNP (100 mA) ²⁾
Error output (max. output current)	2 x alarm
Reference input	2 x zero-ref
Input for memory bank selection	3 x bank
Hold input	2 x hold, 1 x hold-reset
Data interface	RS-232

¹⁾ Source of analog output is either sensor heads, or calculation result.

²⁾ PNP: HIGH = V_S - (< 2 V) / LOW = < 2 V; NPN: HIGH = < 2 V / LOW = V_S.

Mechanics/electronics

Supply voltage V_s	DC 12 V ... 24 V ¹⁾
Power consumption	6 W ²⁾
Warm-up time	≤ 5 min
Housing material	Polycarbonat and nylon 66

¹⁾ DC 12 V (-5 %) ... DC 24 V (+10 %)

²⁾ When connected with two sensor heads, incl. analog current output.

³⁾ Inclusive terminal board.

Connection type	Terminal board
Indication	1,4" color display
Weight	240 g ³⁾

1) DC 12 V (-5 %) ... DC 24 V (+10 %)

2) When connected with two sensor heads, incl. analog current output.

3) Inclusive terminal board.

Ambient data

Enclosure rating	IP 20
Protection class	III
Ambient temperature	Operation: -10 °C ... +45 °C Storage: -20 °C ... +60 °C
Relative air humidity (non-condensing)	35 % ... 85 %
Vibration resistance	10 Hz ... 55 Hz (amplitude 1.5 mm, x-, y-, z-axis 2 hours each)
Shock resistance	50 G (x, y, z axis 3 times each)

General notes

Note on use	OD Max sensor head OD25-x is only to be used with AODG-P/N1; All other types (OD350-x, OD85-x, OD30-x) are to be used with AOD-P/N1
--------------------	---

Dimensional drawing (Dimensions in mm (inch))

AOD-xx AODG-xx

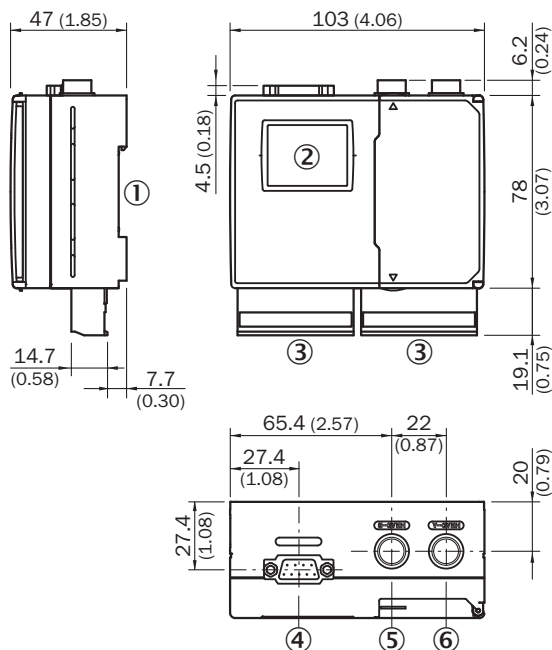

- ① DIN rail mounting
- ② LC display
- ③ Terminal board (detachable)
- ④ RS-232C interface
- ⑤ Sensor head B connection port
- ⑥ Sensor head A connection port

Connection type

Evaluation unit RS-232C

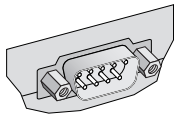

Terminal block evaluation unit

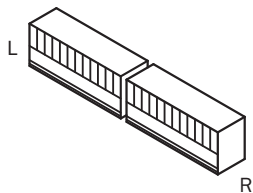

Connection diagram

Terminal block connection diagram

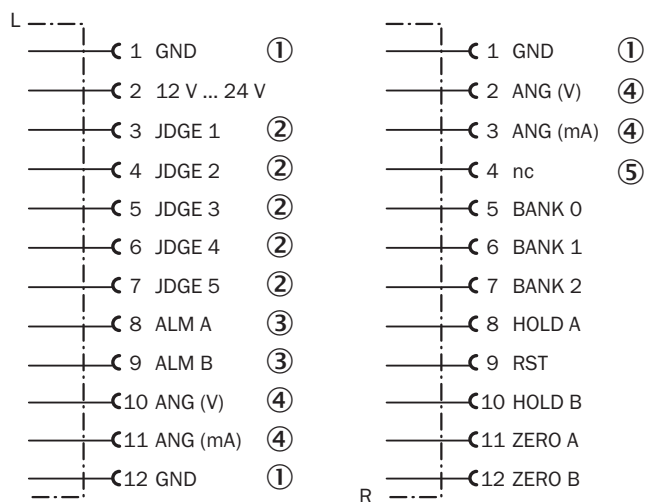

- ① Ground (0 V)
- ② Judgement Output = switching output
- ③ Alarm output
- ④ Analog output
- ⑤ Not assigned

Evaluation unit RS-232C

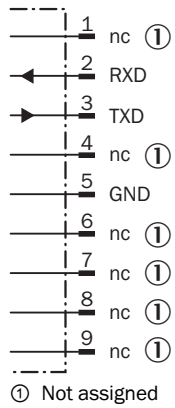

Adjustment possible

AOD-xx AODG-xx

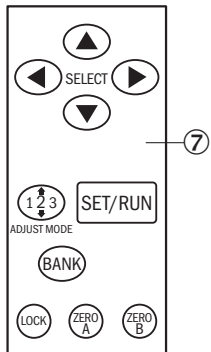

⑦ Operating elements

Recommended accessories

Other models and accessories → www.sick.com/OD_Max

	Brief description	Type	Part no.
Adapters and distributors			
		TERM.-AOD/AODG	6033129
Plug connectors and cables			
	Head A: female connector, M12, 10-pin, straight Head B: male connector, M12, 10-pin, straight Cable: unshielded, 2 m	DSL-1210-G02M	6028943
	Head A: female connector, M12, 10-pin, straight Head B: male connector, M12, 10-pin, straight Cable: unshielded, 5 m	DSL-1210-G05M	6028944

	Brief description	Type	Part no.
	Head A: female connector, M12, 10-pin, straight Head B: male connector, M12, 10-pin, straight Cable: unshielded, 10 m	DSL-1210-G10M	6033614

SICK AT A GLANCE

SICK is one of the leading manufacturers of intelligent sensors and sensor solutions for industrial applications. A unique range of products and services creates the perfect basis for controlling processes securely and efficiently, protecting individuals from accidents and preventing damage to the environment.

We have extensive experience in a wide range of industries and understand their processes and requirements. With intelligent sensors, we can deliver exactly what our customers need. In application centers in Europe, Asia and North America, system solutions are tested and optimized in accordance with customer specifications. All this makes us a reliable supplier and development partner.

Comprehensive services complete our offering: SICK LifeTime Services provide support throughout the machine life cycle and ensure safety and productivity.

For us, that is “Sensor Intelligence.”

WORLDWIDE PRESENCE:

Contacts and other locations –www.sick.com