

Small Signal Zener Diodes



FEATURES

- Silicon planar Zener diodes
- The Zener voltages are graded according to the international E24 standard
- AEC-Q101 qualified
- ESD capability according to AEC-Q101:
Human body model > 8 kV
Machine model > 800 V
- Base P/N-E3 - RoHS-compliant, commercial grade
- Base P/N-HE3 - RoHS-compliant, AEC-Q101 qualified
- Material categorization: For definitions of compliance please see www.vishay.com/doc?99912

RoHS
COMPLIANT

PRIMARY CHARACTERISTICS		
PARAMETER	VALUE	UNIT
V _Z range nom.	2.4 to 75	V
Test current I _{ZT}	2.5; 5	mA
V _Z specification	Pulse current	
Int. construction	Single	

ORDERING INFORMATION			
DEVICE NAME	ORDERING CODE	TAPED UNITS PER REEL	MINIMUM ORDER QUANTITY
BZT52-series	BZT52C2V4-E3-08 to BZT52C75-E3-08	3000 (8 mm tape on 7" reel)	15 000/box
	BZT52B2V4-E3-08 to BZT52B75-E3-08		
	BZT52C2V4-HE3-08 to BZT52C75-HE3-08		
	BZT52B2V4-HE3-08 to BZT52B75-HE3-08		
	BZT52C2V4-E3-18 to BZT52C75-E3-18	10 000 (8 mm tape on 13" reel)	10 000/box
	BZT52B2V4-E3-18 to BZT52B75-E3-18		
	BZT52C2V4-HE3-18 to BZT52C75-HE3-18		
	BZT52B2V4-HE3-18 to BZT52B75-HE3-18		

PACKAGE				
PACKAGE NAME	WEIGHT	MOLDING COMPOUND FLAMMABILITY RATING	MOISTURE SENSITIVITY LEVEL	SOLDERING CONDITIONS
SOD-123	10.3 mg	UL 94 V-0	MSL level 1 (according J-STD-020)	260 °C/10 s at terminals

ABSOLUTE MAXIMUM RATINGS (T _{amb} = 25 °C, unless otherwise specified)				
PARAMETER	TEST CONDITION	SYMBOL	VALUE	UNIT
Power dissipation	Diode on ceramic substrate 0.7 mm; 5 mm ² pad areas	P _{tot}	500	mW
	Diode on ceramic substrate 0.7 mm; 2.5 mm ² pad areas	P _{tot}	410	mW
Zener current	See table "Electrical Characteristics "			
Thermal resistance junction to ambient air	Valid provided that electrodes are kept at ambient temperature	R _{thJA}	300	K/W
Junction temperature		T _j	150	°C
Storage temperature range		T _{stg}	- 65 to + 150	°C
Operating temperature range		T _{op}	- 55 to + 150	°C



ELECTRICAL CHARACTERISTICS (T _{amb} = 25 °C, unless otherwise specified)													
PART NUMBER	MARKING CODE	ZENER VOLTAGE RANGE ⁽¹⁾			TEST CURRENT		REVERSE VOLTAGE		DYNAMIC RESISTANCE		TEMP. COEFFICIENT	ADMISSABLE ZENER CURRENT ⁽⁴⁾	
		V _Z at I _{ZT1}			I _{ZT1}	I _{ZT2}	V _R at I _R		Z _Z at I _{ZT1}	Z _{ZK} at I _{ZT2}	α _{VZ}	I _Z at T _{amb} = 45 °C	I _Z at T _{amb} = 25 °C
		V			mA		V	nA	Ω		10 ⁻⁴ /°C	mA	
		MIN.	NOM.	MAX.									
BZT52C2V4	W1	2.2	2.4	2.6	5	1	-	-	85	600	- 9 to - 4	-	-
BZT52C2V7	W2	2.5	2.7	2.9	5	1	-	-	75 (< 83)	< 500	- 9 to - 4	113	134
BZT52C3V0	W3	2.8	3.0	3.2	5	1	-	-	80 (< 95)	< 500	- 9 to - 3	98	118
BZT52C3V3	W4	3.1	3.3	3.5	5	1	-	-	80 (< 95)	< 500	- 8 to - 3	92	109
BZT52C3V6	W5	3.4	3.6	3.8	5	1	-	-	80 (< 95)	< 500	- 8 to - 3	85	100
BZT52C3V9	W6	3.7	3.9	4.1	5	1	-	-	80 (< 95)	< 500	- 7 to - 3	77	92
BZT52C4V3	W7	4	4.3	4.6	5	1	-	-	80 (< 95)	< 500	- 6 to - 1	71	84
BZT52C4V7	W8	4.4	4.7	5	5	1	-	-	70 (< 78)	< 500	- 5 to + 2	64	76
BZT52C5V1	W9	4.8	5.1	5.4	5	1	> 0.8	100	30 (< 60)	< 480	- 3 to + 4	56	67
BZT52C5V6	WA	5.2	5.6	6	5	1	> 1	100	10 (< 40)	< 400	- 2 to + 6	50	59
BZT52C6V2	WB	5.8	6.2	6.6	5	1	> 2	100	4.8 (< 10)	< 200	- 1 to + 7	45	54
BZT52C6V8	WC	6.4	6.8	7.2	5	1	> 3	100	4.5 (< 8)	< 150	+ 2 to + 7	41	49
BZT52C7V5	WD	7	7.5	7.9	5	1	> 5	100	4 (< 7)	< 50	+ 3 to + 7	37	44
BZT52C8V2	WE	7.7	8.2	8.7	5	1	> 6	100	4.5 (< 7)	< 50	+ 4 to + 7	34	40
BZT52C9V1	WF	8.5	9.1	9.6	5	1	> 7	100	4.8 (< 10)	< 50	+ 5 to + 8	30	36
BZT52C10	WG	9.4	10	10.6	5	1	> 7.5	100	5.2 (< 15)	< 70	+ 5 to + 8	28	33
BZT52C11	WH	10.4	11	11.6	5	1	> 8.5	100	6 (< 20)	< 70	+ 5 to + 9	25	30
BZT52C12	WI	11.4	12	12.7	5	1	> 9	100	7 (< 20)	< 90	+ 6 to + 9	23	28
BZT52C13	WK	12.4	13	14.1	5	1	> 10	100	9 (< 25)	< 110	+ 7 to + 9	21	25
BZT52C15	WL	13.8	15	15.6	5	1	> 11	100	11 (< 30)	< 110	+ 7 to + 9	19	23
BZT52C16	WM	15.3	16	17.1	5	1	> 12	100	13 (< 40)	< 170	+ 8 to + 9.5	17	20
BZT52C18	WN	16.8	18	19.1	5	1	> 14	100	18 (< 50)	< 170	+ 8 to + 9.5	15	18
BZT52C20	WO	18.8	20	21.2	5	1	> 15	100	20 (< 50)	< 220	+ 8 to + 10	14	17
BZT52C22	WP	20.8	22	23.3	5	1	> 17	100	25 (< 55)	< 220	+ 8 to + 10	13	16
BZT52C24	WR	22.8	24	25.6	5	1	> 18	100	28 (< 80)	< 220	+ 8 to + 10	11	13
BZT52C27	WS	25.1	27	28.9	5	1	> 20	100	30 (< 80)	< 250	+ 8 to + 10	10	12
BZT52C30	WT	28	30	32	5	1	> 22.5	100	35 (< 80)	< 250	+ 8 to + 10	9	10
BZT52C33	WU	31	33	35	5	1	> 25	100	40 (< 80)	< 250	+ 8 to + 10	8	9
BZT52C36	WW	34	36	38	5	1	> 27	100	40 (< 90)	< 250	+ 8 to + 10	8	9
BZT52C39	WX	37	39	41	5	1	> 29	100	50 (< 90)	< 300	+ 10 to + 12	7	8
BZT52C43	WY	40	43	46	5	1	> 32	100	60 (< 100)	< 700	+ 10 to + 12	6	7
BZT52C47	WZ	44	47	50	5	1	> 35	100	70 (< 100)	< 750	+ 10 to + 12	5	6
BZT52C51	X1	48	51	54	5	1	> 38	100	70 (< 100)	< 750	+ 10 to + 12	5	6
BZT52C56	X2	52	56	60	2.5	0.5	-	-	< 135 ⁽²⁾	< 1000 ⁽³⁾	typ. +10 ⁽²⁾	-	-
BZT52C62	X3	58	62	66	2.5	0.5	-	-	< 150 ⁽²⁾	< 1000 ⁽³⁾	typ. +10 ⁽²⁾	-	-
BZT52C68	X4	64	68	72	2.5	0.5	-	-	< 200 ⁽²⁾	< 1000 ⁽³⁾	typ. +10 ⁽²⁾	-	-
BZT52C75	X5	70	75	79	2.5	0.5	-	-	< 250 ⁽²⁾	< 1500 ⁽³⁾	typ. +10 ⁽²⁾	-	-

Notes

- I_{ZT1} = 5 mA, I_{ZT2} = 1 mA
- (1) Measured with pulses t_p = 5 ms
- (2) I_{ZT1} = 2.5 mA
- (3) I_{ZT2} = 0.5 mA
- (4) Valid provided that electrodes are kept at ambient temperature



ELECTRICAL CHARACTERISTICS (T _{amb} = 25 °C, unless otherwise specified)													
PART NUMBER	MARKING CODE	ZENER VOLTAGE RANGE ⁽¹⁾			TEST CURRENT		REVERSE VOLTAGE		DYNAMIC RESISTANCE		TEMP. COEFFICIENT	ADMISSABLE ZENER CURRENT ⁽⁴⁾	
		V _Z at I _{ZT1}			I _{ZT1}	I _{ZT2}	V _R at I _R		Z _Z at I _{ZT1}	Z _{ZK} at I _{ZT2}	α _{VZ}	I _Z at T _{amb} = 45 °C	I _Z at T _{amb} = 25 °C
		V			mA		V	nA	Ω		10 ⁻⁴ /°C	mA	
		MIN.	NOM.	MAX.									
BZT52B2V4	W1	2.35	2.4	2.45	5	1	-	-	85	600	-9 to -4	-	-
BZT52B2V7	W2	2.65	2.7	2.75	5	1	-	-	75 (< 83)	< 500	-9 to -4	113	134
BZT52B3V0	W3	2.94	3.0	3.06	5	1	-	-	80 (< 95)	< 500	-9 to -3	98	118
BZT52B3V3	W4	3.23	3.3	3.37	5	1	-	-	80 (< 95)	< 500	-8 to -3	92	109
BZT52B3V6	W5	3.53	3.6	3.67	5	1	-	-	80 (< 95)	< 500	-8 to -3	85	100
BZT52B3V9	W6	3.82	3.9	3.98	5	1	-	-	80 (< 95)	< 500	-7 to -3	77	92
BZT52B4V3	W7	4.21	4.3	4.39	5	1	-	-	80 (< 95)	< 500	-6 to -1	71	84
BZT52B4V7	W8	4.61	4.7	4.79	5	1	-	-	70 (< 78)	< 500	-5 to +2	64	76
BZT52B5V1	W9	5	5.1	5.2	5	1	> 0.8	100	30 (< 60)	< 480	-3 to +4	56	67
BZT52B5V6	WA	5.49	5.6	5.71	5	1	> 1	100	10 (< 40)	< 400	-2 to +6	50	59
BZT52B6V2	WB	6.08	6.2	6.32	5	1	> 2	100	4.8 (< 10)	< 200	-1 to +7	45	54
BZT52B6V8	WC	6.66	6.8	6.94	5	1	> 3	100	4.5 (< 8)	< 150	+2 to +7	41	49
BZT52B7V5	WD	7.35	7.5	7.65	5	1	> 5	100	4 (< 7)	< 50	+3 to +7	37	44
BZT52B8V2	WE	8.04	8.2	8.36	5	1	> 6	100	4.5 (< 7)	< 50	+4 to +7	34	40
BZT52B9V1	WF	8.92	9.1	9.28	5	1	> 7	100	4.8 (< 10)	< 50	+5 to +8	30	36
BZT52B10	WG	9.8	10	10.2	5	1	> 7.5	100	5.2 (< 15)	< 70	+5 to +8	28	33
BZT52B11	WH	10.8	11	11.2	5	1	> 8.5	100	6 (< 20)	< 70	+5 to +9	25	30
BZT52B12	WI	11.8	12	12.2	5	1	> 9	100	7 (< 20)	< 90	+6 to +9	23	28
BZT52B13	WK	12.7	13	13.3	5	1	> 10	100	9 (< 25)	< 110	+7 to +9	21	25
BZT52B15	WL	14.7	15	15.3	5	1	> 11	100	11 (< 30)	< 110	+7 to +9	19	23
BZT52B16	WM	15.7	16	16.3	5	1	> 12	100	13 (< 40)	< 170	+8 to +9.5	17	20
BZT52B18	WN	17.6	18	18.4	5	1	> 14	100	18 (< 50)	< 170	+8 to +9.5	15	18
BZT52B20	WO	19.6	20	20.4	5	1	> 15	100	20 (< 50)	< 220	+8 to +10	14	17
BZT52B22	WP	21.6	22	22.4	5	1	> 17	100	25 (< 55)	< 220	+8 to +10	13	16
BZT52B24	WR	23.5	24	24.5	5	1	> 18	100	28 (< 80)	< 220	+8 to +10	11	13
BZT52B27	WS	26.5	27	27.5	5	1	> 20	100	30 (< 80)	< 250	+8 to +10	10	12
BZT52B30	WT	29.4	30	30.6	5	1	> 22.5	100	35 (< 80)	< 250	+8 to +10	9	10
BZT52B33	WU	32.3	33	33.7	5	1	> 25	100	40 (< 80)	< 250	+8 to +10	8	9
BZT52B36	WW	35.3	36	36.7	5	1	> 27	100	40 (< 90)	< 250	+8 to +10	8	9
BZT52B39	WX	38.2	39	39.8	5	1	> 29	100	50 (< 90)	< 300	+10 to +12	7	8
BZT52B43	WY	42.1	43	43.9	5	1	> 32	100	60 (< 100)	< 700	+10 to +12	6	7
BZT52B47	WZ	46.1	47	47.9	5	1	> 35	100	70 (< 100)	< 750	+10 to +12	5	6
BZT52B51	X1	50	51	52	5	1	> 38	100	70 (< 100)	< 750	+10 to +12	5	6
BZT52B56	X2	54.9	56	57.1	2.5	0.5	-	-	< 135 ⁽²⁾	< 1000 ⁽³⁾	typ. + 10 ⁽²⁾	-	-
BZT52B62	X3	60.8	62	63.2	2.5	0.5	-	-	< 150 ⁽²⁾	< 1000 ⁽³⁾	typ. + 10 ⁽²⁾	-	-
BZT52B68	X4	66.6	68	69.4	2.5	0.5	-	-	< 200 ⁽²⁾	< 1000 ⁽³⁾	typ. + 10 ⁽²⁾	-	-
BZT52B75	X5	73.5	75	76.5	2.5	0.5	-	-	< 250 ⁽²⁾	< 1500 ⁽³⁾	typ. + 10 ⁽²⁾	-	-

Notes

- I_{ZT1} = 5 mA, I_{ZT2} = 1 mA
- (1) Measured with pulses t_p = 5 ms
- (2) I_{ZT1} = 2.5 mA
- (3) I_{ZT2} = 0.5 mA
- (4) Valid provided that electrodes are kept at ambient temperature

TYPICAL CHARACTERISTICS ($T_{amb} = 25\text{ }^{\circ}\text{C}$, unless otherwise specified)

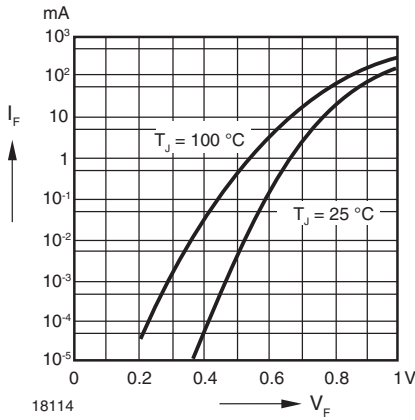

Fig. 1 - Forward characteristics

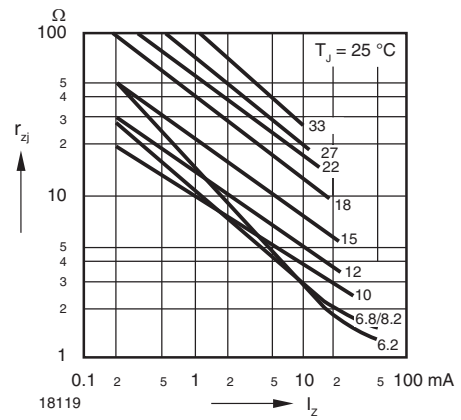

Fig. 4 - Dynamic Resistance vs. Zener Current

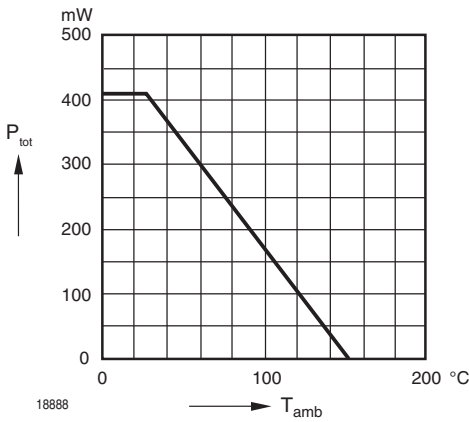

Fig. 2 - Admissible Power Dissipation vs. Ambient Temperature

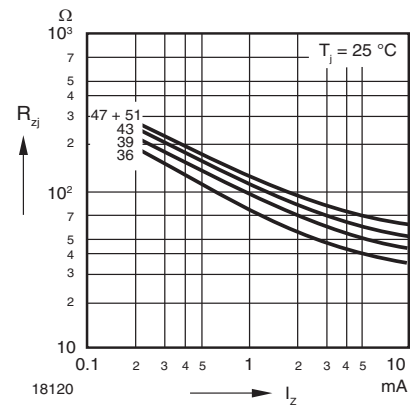

Fig. 5 - Dynamic Resistance vs. Zener Current

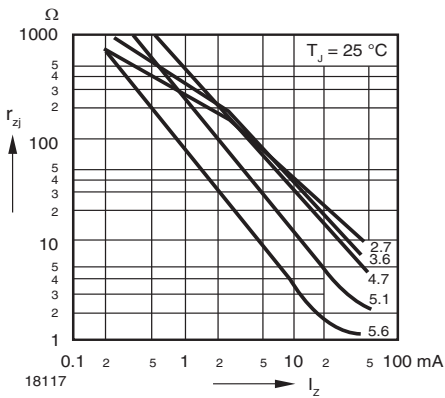

Fig. 3 - Dynamic Resistance vs. Zener Current

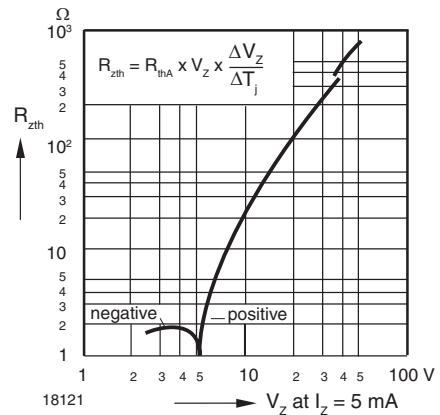

Fig. 6 - Thermal Differential Resistance vs. Zener Voltage

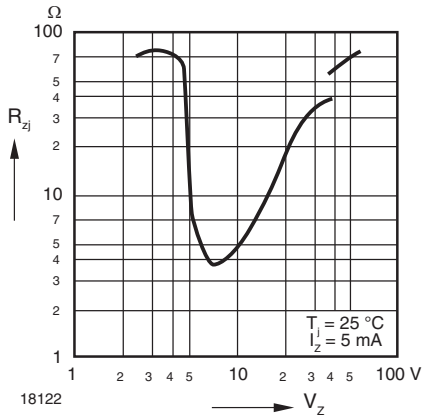

Fig. 7 - Dynamic Resistance vs. Zener Voltage

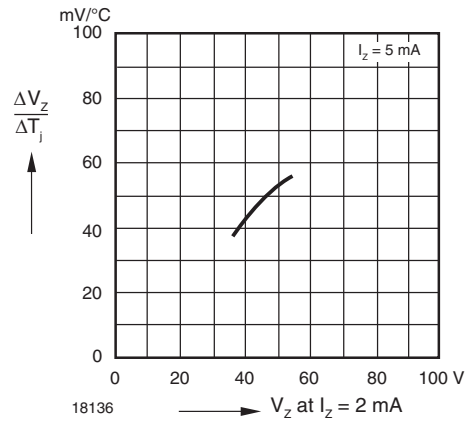

Fig. 10 - Temperature Dependence of Zener Voltage vs. Zener Voltage

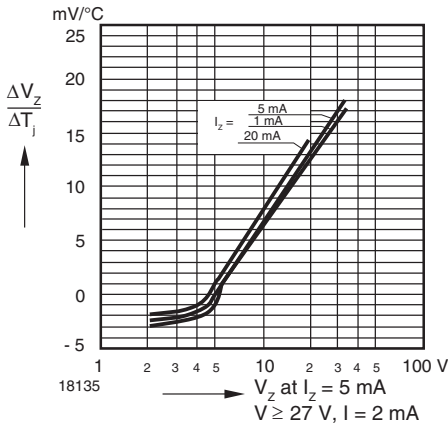

Fig. 8 - Temperature Dependence of Zener Voltage vs. Zener Voltage

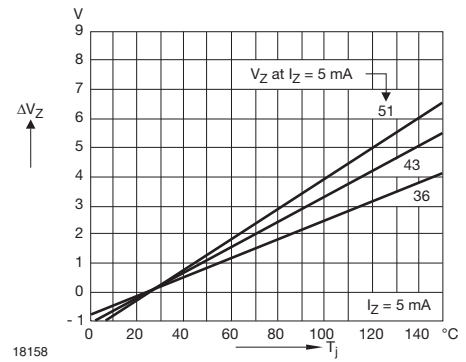

Fig. 11 - Change of Zener Voltage vs. Junction Temperature

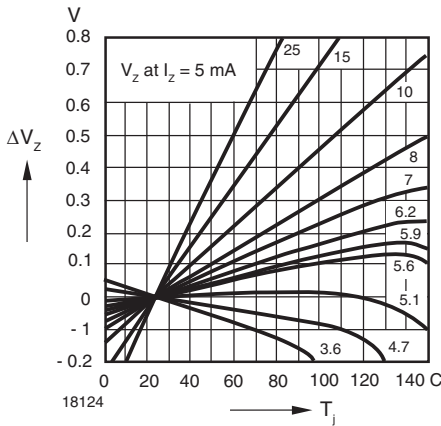

Fig. 9 - Change of Zener Voltage vs. Junction Temperature

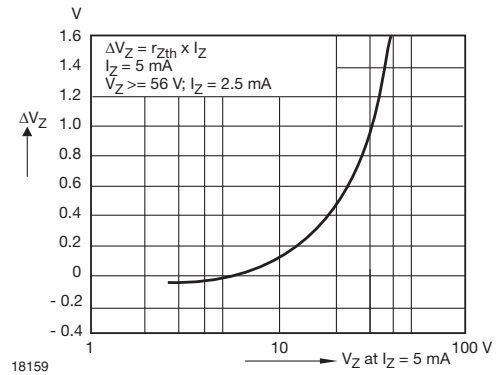

Fig. 12 - Change of Zener Voltage from Turn-on up to the Point of Thermal Equilibrium vs. Zener Voltage

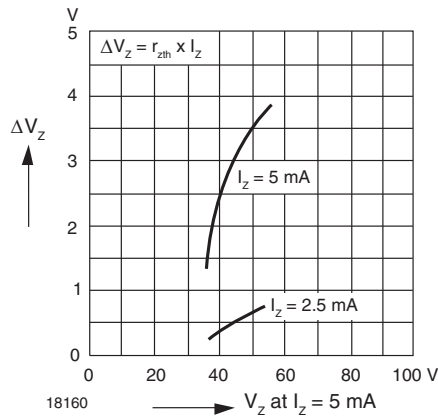

Fig. 13 - Change of Zener Voltage from Turn-on up to the Point of Thermal Equilibrium vs. Zener Voltage

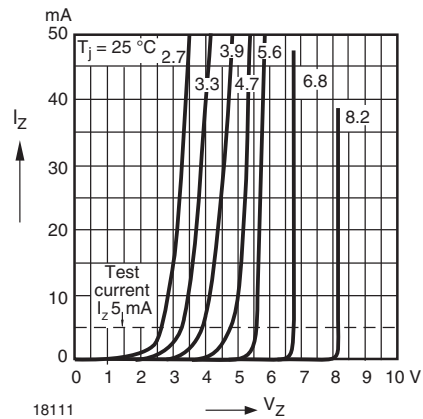

Fig. 14 - Breakdown Characteristics

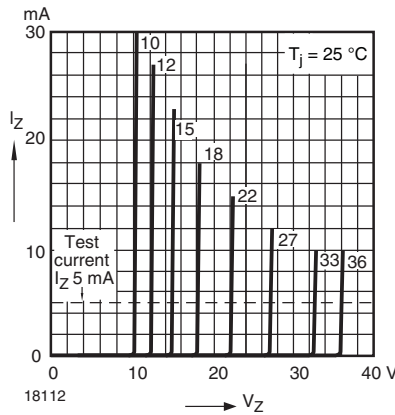

Fig. 15 - Breakdown Characteristics

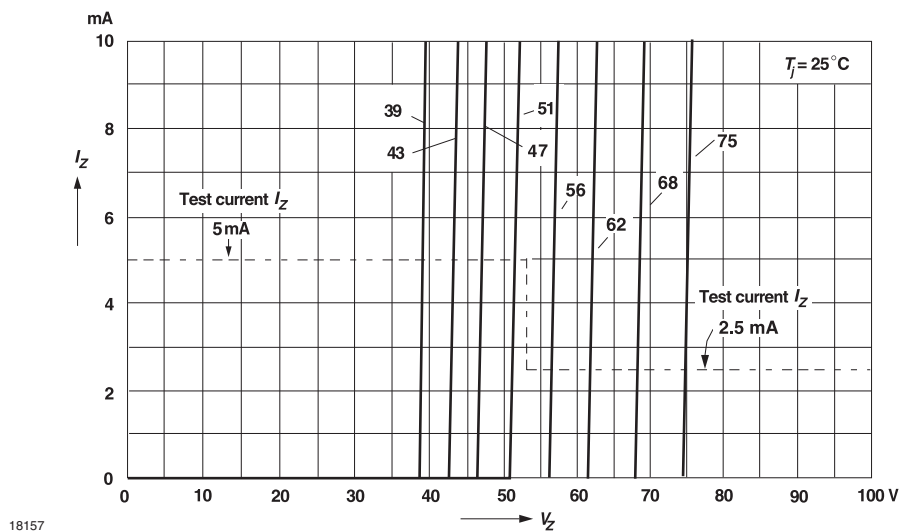
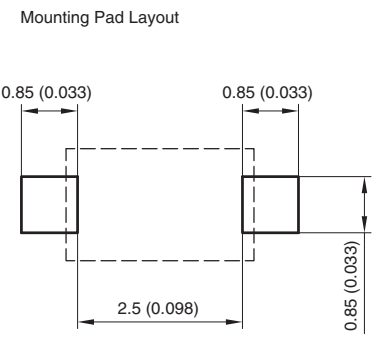
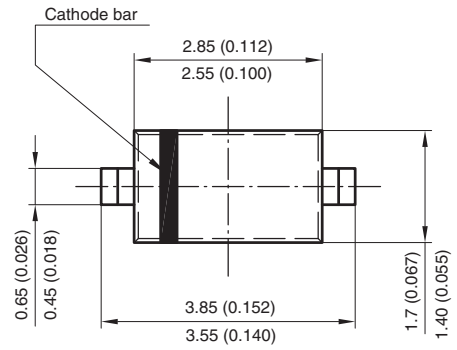
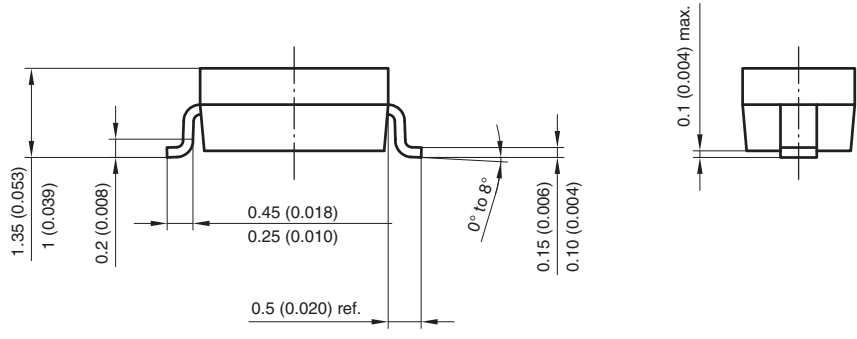

Fig. 16 - Breakdown Characteristics



PACKAGE DIMENSIONS in millimeters (inches): SOD-123



Rev. 4 - Date: 24. Sep. 2009
 Document no.: S8-V-3910.01-001 (4)
 17432



Disclaimer

ALL PRODUCT, PRODUCT SPECIFICATIONS AND DATA ARE SUBJECT TO CHANGE WITHOUT NOTICE TO IMPROVE RELIABILITY, FUNCTION OR DESIGN OR OTHERWISE.

Vishay Intertechnology, Inc., its affiliates, agents, and employees, and all persons acting on its or their behalf (collectively, "Vishay"), disclaim any and all liability for any errors, inaccuracies or incompleteness contained in any datasheet or in any other disclosure relating to any product.

Vishay makes no warranty, representation or guarantee regarding the suitability of the products for any particular purpose or the continuing production of any product. To the maximum extent permitted by applicable law, Vishay disclaims (i) any and all liability arising out of the application or use of any product, (ii) any and all liability, including without limitation special, consequential or incidental damages, and (iii) any and all implied warranties, including warranties of fitness for particular purpose, non-infringement and merchantability.

Statements regarding the suitability of products for certain types of applications are based on Vishay's knowledge of typical requirements that are often placed on Vishay products in generic applications. Such statements are not binding statements about the suitability of products for a particular application. It is the customer's responsibility to validate that a particular product with the properties described in the product specification is suitable for use in a particular application. Parameters provided in datasheets and/or specifications may vary in different applications and performance may vary over time. All operating parameters, including typical parameters, must be validated for each customer application by the customer's technical experts. Product specifications do not expand or otherwise modify Vishay's terms and conditions of purchase, including but not limited to the warranty expressed therein.

Except as expressly indicated in writing, Vishay products are not designed for use in medical, life-saving, or life-sustaining applications or for any other application in which the failure of the Vishay product could result in personal injury or death. Customers using or selling Vishay products not expressly indicated for use in such applications do so at their own risk. Please contact authorized Vishay personnel to obtain written terms and conditions regarding products designed for such applications.

No license, express or implied, by estoppel or otherwise, to any intellectual property rights is granted by this document or by any conduct of Vishay. Product names and markings noted herein may be trademarks of their respective owners.

Material Category Policy

Vishay Intertechnology, Inc. hereby certifies that all its products that are identified as RoHS-Compliant fulfill the definitions and restrictions defined under Directive 2011/65/EU of The European Parliament and of the Council of June 8, 2011 on the restriction of the use of certain hazardous substances in electrical and electronic equipment (EEE) - recast, unless otherwise specified as non-compliant.

Please note that some Vishay documentation may still make reference to RoHS Directive 2002/95/EC. We confirm that all the products identified as being compliant to Directive 2002/95/EC conform to Directive 2011/65/EU.

Vishay Intertechnology, Inc. hereby certifies that all its products that are identified as Halogen-Free follow Halogen-Free requirements as per JEDEC JS709A standards. Please note that some Vishay documentation may still make reference to the IEC 61249-2-21 definition. We confirm that all the products identified as being compliant to IEC 61249-2-21 conform to JEDEC JS709A standards.

Mouser Electronics

Authorized Distributor

Click to View Pricing, Inventory, Delivery & Lifecycle Information:

Vishay:

[BZT52C24-GS08](#) [BZT52C8V2-V-GS08](#) [BZT52C36-V-GS08](#) [BZT52C12-V-GS08](#) [BZT52C24-V-GS08](#) [BZT52C9V1-V-GS08](#) [BZT52C16-V-GS08](#) [BZT52C13-V-GS08](#) [BZT52C10-V-GS08](#) [BZT52C22-V-GS08](#) [BZT52C4V3-V-GS08](#) [BZT52C27-V-GS08](#) [BZT52C5V6-V-GS08](#) [BZT52C3V9-V-GS08](#) [BZT52C30-V-GS08](#) [BZT52B10-V-GS08](#) [BZT52B10-V-GS18](#) [BZT52B11-V-GS08](#) [BZT52B11-V-GS18](#) [BZT52B12-V-GS08](#) [BZT52B12-V-GS18](#) [BZT52B13-V-GS08](#) [BZT52B13-V-GS18](#) [BZT52B15-V-GS08](#) [BZT52B15-V-GS18](#) [BZT52B16-V-GS08](#) [BZT52B16-V-GS18](#) [BZT52B18-V-GS08](#) [BZT52B18-V-GS18](#) [BZT52B2V4-V-GS08](#) [BZT52B2V4-V-GS18](#) [BZT52B2V7-V-GS08](#) [BZT52B2V7-V-GS18](#) [BZT52B20-V-GS08](#) [BZT52B20-V-GS18](#) [BZT52B22-V-GS08](#) [BZT52B22-V-GS18](#) [BZT52B24-V-GS08](#) [BZT52B24-V-GS18](#) [BZT52B27-V-GS08](#) [BZT52B27-V-GS18](#) [BZT52B3V0-V-GS08](#) [BZT52B3V0-V-GS18](#) [BZT52B3V3-V-GS08](#) [BZT52B3V3-V-GS18](#) [BZT52B3V6-V-GS08](#) [BZT52B3V6-V-GS18](#) [BZT52B3V9-V-GS08](#) [BZT52B3V9-V-GS18](#) [BZT52B30-V-GS08](#) [BZT52B30-V-GS18](#) [BZT52B33-V-GS08](#) [BZT52B33-V-GS18](#) [BZT52B36-V-GS08](#) [BZT52B36-V-GS18](#) [BZT52B39-V-GS08](#) [BZT52B39-V-GS18](#) [BZT52B4V3-V-GS08](#) [BZT52B4V3-V-GS18](#) [BZT52B4V7-V-GS08](#) [BZT52B4V7-V-GS18](#) [BZT52B43-V-GS08](#) [BZT52B43-V-GS18](#) [BZT52B47-V-GS08](#) [BZT52B47-V-GS18](#) [BZT52B5V1-V-GS08](#) [BZT52B5V1-V-GS18](#) [BZT52B5V6-V-GS08](#) [BZT52B5V6-V-GS18](#) [BZT52B51-V-GS08](#) [BZT52B51-V-GS18](#) [BZT52B56-V-GS08](#) [BZT52B56-V-GS18](#) [BZT52B6V2-V-GS08](#) [BZT52B6V2-V-GS18](#) [BZT52B6V8-V-GS08](#) [BZT52B6V8-V-GS18](#) [BZT52B62-V-GS08](#) [BZT52B62-V-GS18](#) [BZT52B68-V-GS08](#) [BZT52B68-V-GS18](#) [BZT52B7V5-V-GS08](#) [BZT52B7V5-V-GS18](#) [BZT52B75-V-GS08](#) [BZT52B75-V-GS18](#) [BZT52B8V2-V-GS08](#) [BZT52B8V2-V-GS18](#) [BZT52B9V1-V-GS08](#) [BZT52B9V1-V-GS18](#) [BZT52C10-V-GS18](#) [BZT52C11-V-GS18](#) [BZT52C12-V-GS18](#) [BZT52C13-V-GS18](#) [BZT52C16-V-GS18](#) [BZT52C18-V-GS18](#) [BZT52C2V4-V-GS18](#) [BZT52C2V7-V-GS18](#) [BZT52C20-V-GS18](#) [BZT52C24-V-GS18](#) [BZT52C27-V-GS18](#)