

AN7191K, AN7191Z

Dual 20W BTL Low Frequency Power Amplifier IC for Output

Overview

The AN7191K and AN7191Z are audio power ICs developed for sound output of car audio (20W×2ch.).

High density mounting is possible and they can contribute to cost reduction, because they require fewer external components. It incorporates various protective circuits to provide high reliability and breakage resistance. Particularly, it has realized the supply surge withstand voltage of 100V (typ.).

The AN7191Z enable realize the saved space design with small package.

Features

- Improved breakage resistance performance
 - Supply surge withstand voltage : 80V (typ. 100V)
 - Short-circuit breakage withstand voltage : 25V
- Fewer external components required
 - Electrolytic capacitors for NF (Negative Feedback), BS (Boot-strap) and input coupling not required
- With stand-by function
- With beep sound input pin
- Various protective circuits built-in
 - Protection from atmospheric and ground faults, load short-circuit, over-voltage and -current, and temperature protection

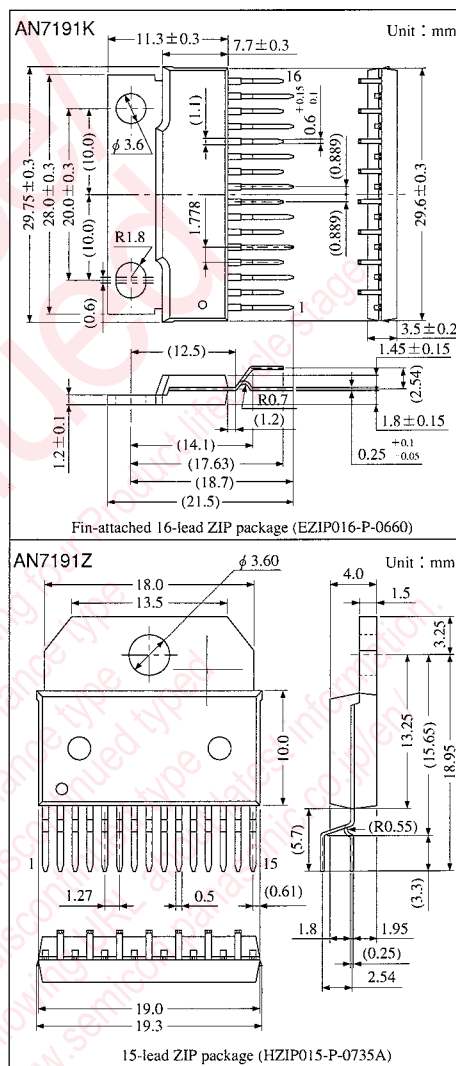

Pin Name

Pin No.	Pin Name	Pin No.	Pin Name
1	V _{CC}	9	GND (Input)
2	Ch.1 Output (+)	10	Beep Sound Input
3	GND (Output Ch.1)	11	Ch.2 Input
4	Ch.1 Output (-)	12	Ripple Filter
5	Stand-by	13	Ch.2 Output (-)
6	Ch.1 Input	14	GND (Output Ch.2)
7	NC	15	Ch.2 Output (+)
8	GND (Substrate)	16	NC (AN7191K)

Note 1) Do not apply voltage or current to NC pin from outside.
 Note 2) The AN7191K is 16-Pin package and the AN7191Z is 15-Pin package.

■ Block Diagram

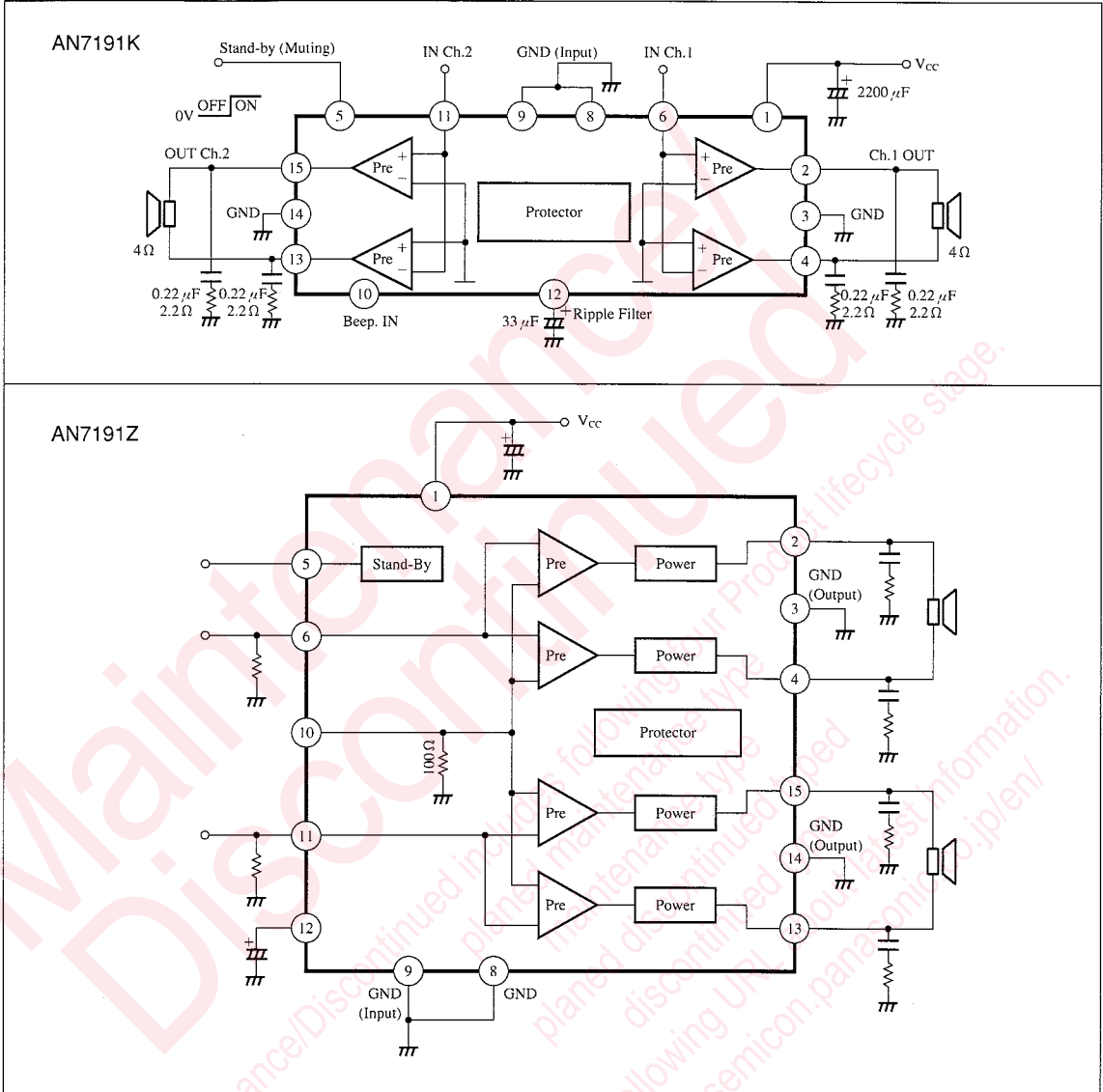

ICs for Audio Common Use

■ Absolute Maximum Ratings (Ta = 25°C)

Parameter	Symbol	Rating		Unit
Supply Voltage ^{Note 1)}	V _{CC}	25		V
Peak Supply Voltage ^{Note 2)}	V _{surge}	80		V
Supply Current	I _{CC}	9		A
Power Dissipation ^{Note 3)}	P _D	AN7191K	32.5	W
		AN7191Z	59.1	
Operating Ambient Temperature	T _{opr}	-30 ~ +85		°C
Storage Temperature	T _{stg}	-55 ~ +150		°C

Note 1) At no signals

Note 2) t = 0.2s

Note 3) Ta = 85°C

Recommended Operating Range (Ta=25°C)

Parameter	Symbol	Range
Operating Supply Voltage Range	V _{CC}	8.0V ~ 18.0V

Electrical Characteristics (V_{CC}=13.2V, f_{req.}=1kHz, Ta=25°C±2°C)

Parameter	Symbol	Condition	min.	typ.	max.	Unit
Quiescent Current	I _{CQ}	V _{IN} =0mV, R _L =4Ω	—	150	250	mA
Stand-by Current	I _{STB}	V _{IN} =0mV, R _L =4Ω	—	1	10	μA
Output Noise Voltage ^{Note 1)}	V _{NO}	R _g =4.7kΩ, R _L =4Ω	—	0.22	0.5	mVrms
Voltage Gain 1	G _{V1}	V _{IN} =40mV, R _L =4Ω	32	34	36	dB
Total Harmonics Distortion 1	THD1	V _{IN} =40mV, R _L =4Ω	—	0.05	0.4	%
Max. Output Power 1	P _{O1}	THD=10%, R _L =4Ω	15	17	—	W
Ripple Rejection Ratio ^{Note 1)}	RR	R _L =4Ω, V _r =0V, V _r =1Vrms, fr=120Hz	55	70	—	dB
Channel Balance	CB	V _{IN} =40mV, R _L =4Ω	—	0	1	dB
Crosstalk ^{Note 1)}	CT	V _{IN} =40mV, R _L =4Ω, R _g =4.7kΩ	55	70	—	dB
Output Offset Voltage	V _{off}	R _g =4.7kΩ, R _L =4Ω	-250	0	250	mV
Input Impedance	Z _i	V _{IN} =±0.3V _{DC}	25	30	36	kΩ
Voltage Gain 2	G _{V2}	V _{IN} =40mV, R _L =2Ω	32	34	36	dB
Total Harmonics Distortion 2	THD2	V _{IN} =40mV, R _L =2Ω	—	0.08	0.8	%
Max. Output Power 2	P _{O2}	THD=10%, R _L =2Ω	15	20	—	W

Note 1) Measured through 15Hz to 30kHz (12dB/OCT) filter

Characteristic Curve

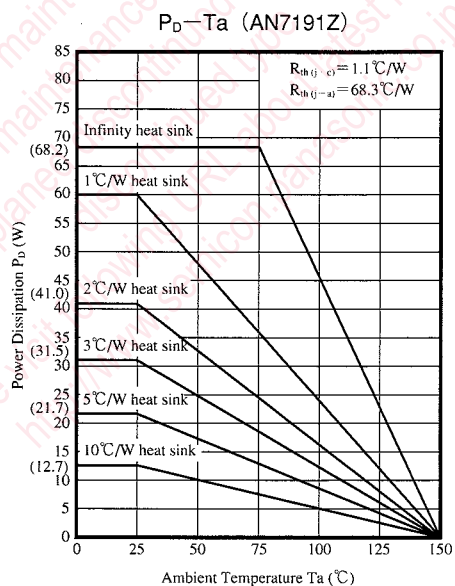
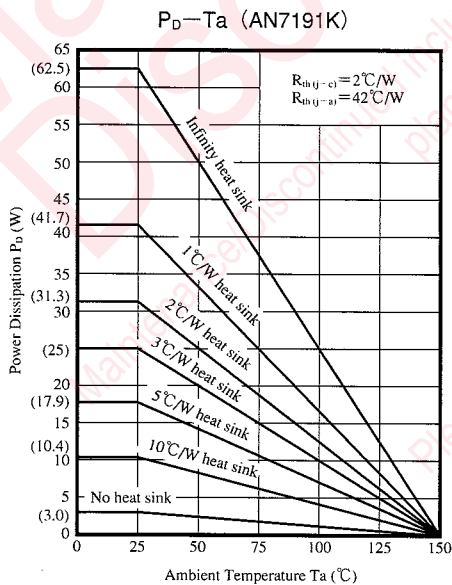

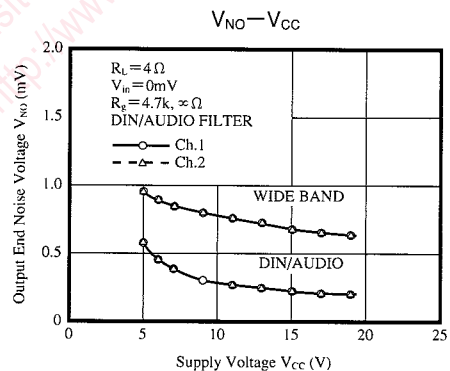
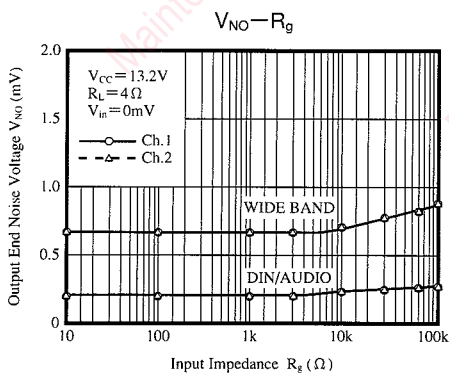
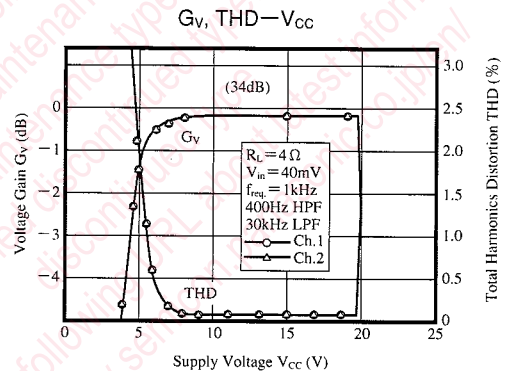
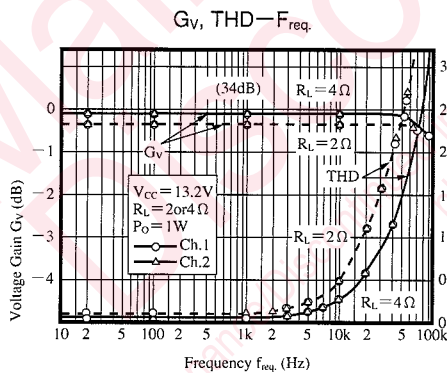
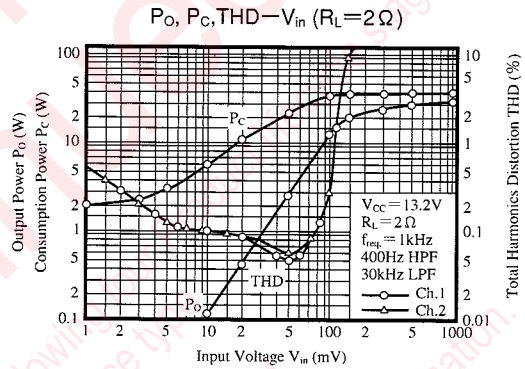
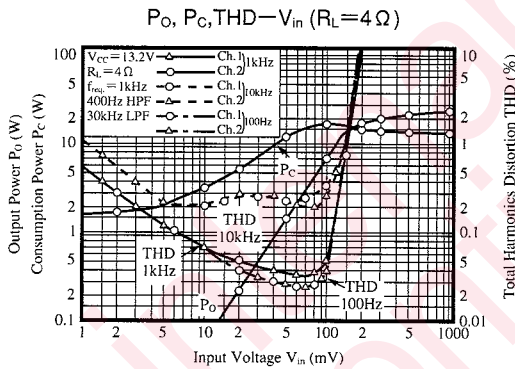
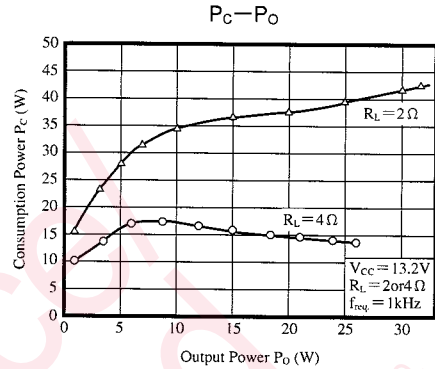
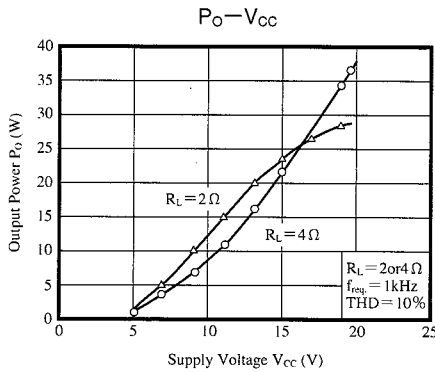

ICs for Audio Common Use

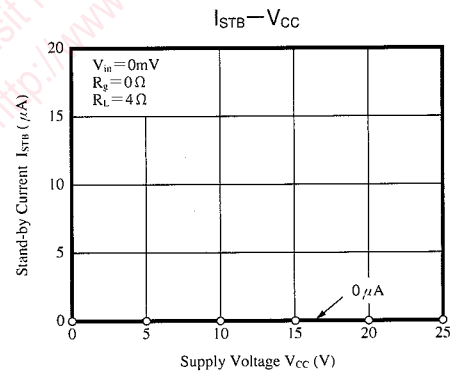
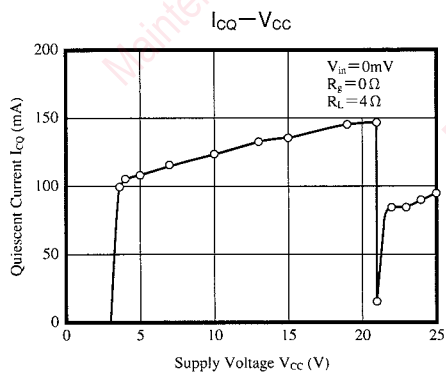
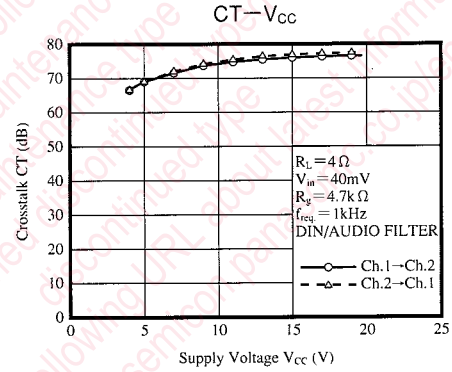
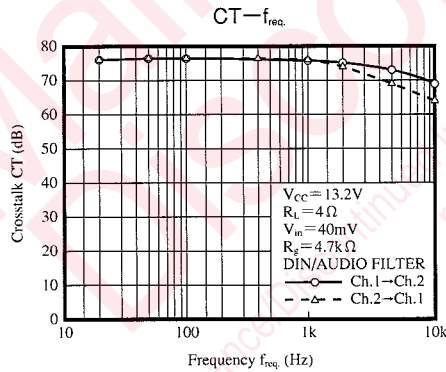
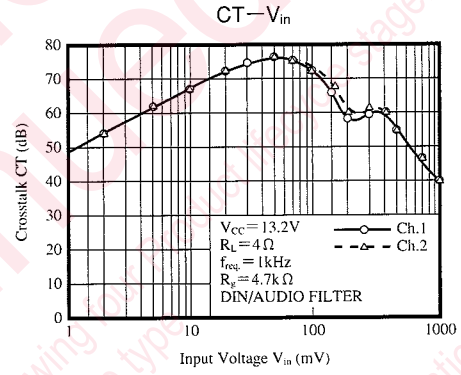
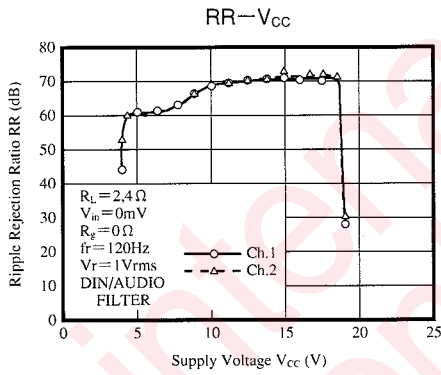
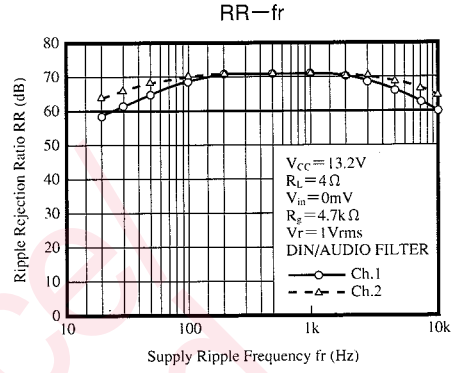
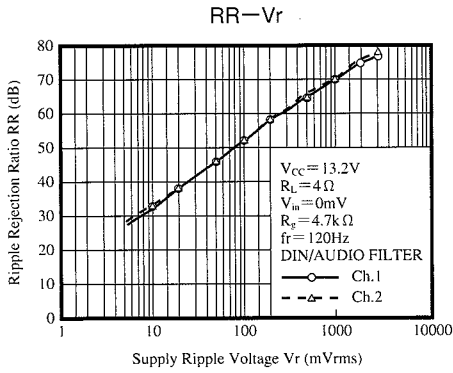

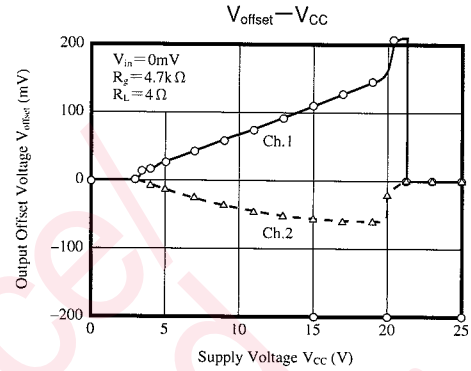
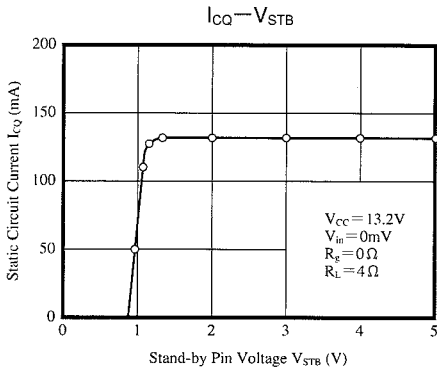

■ Precautions on use

1. Always attach an outside heat sink to use the chip. In addition, the outside heat sink must be fastened onto a chassis for use.
2. Connect the radiation fin to the GND potential.
3. Prevent atmospheric and ground faults, and load short-circuit.
4. The temperature protective circuit gets actuated when $T_j = \text{approx. } 150^\circ\text{C}$, but it is automatically reset when the chip temperature drops below the above set level.
5. The overvoltage protective circuit starts the protective operation at $V_{CC} = \text{approx. } 20V$.
6. Take into consideration the heat radiation design particularly when V_{CC} is set high or when the load is 2Ω .
7. When the beep sound function is not used, connect the beep sound input pin (Pin⑩) with Pin⑨.

Request for your special attention and precautions in using the technical information and semiconductors described in this book

- (1) If any of the products or technical information described in this book is to be exported or provided to non-residents, the laws and regulations of the exporting country, especially, those with regard to security export control, must be observed.
- (2) The technical information described in this book is intended only to show the main characteristics and application circuit examples of the products. No license is granted in and to any intellectual property right or other right owned by Panasonic Corporation or any other company. Therefore, no responsibility is assumed by our company as to the infringement upon any such right owned by any other company which may arise as a result of the use of technical information described in this book.
- (3) The products described in this book are intended to be used for standard applications or general electronic equipment (such as office equipment, communications equipment, measuring instruments and household appliances).
Consult our sales staff in advance for information on the following applications:
 - Special applications (such as for airplanes, aerospace, automobiles, traffic control equipment, combustion equipment, life support systems and safety devices) in which exceptional quality and reliability are required, or if the failure or malfunction of the products may directly jeopardize life or harm the human body.
 - Any applications other than the standard applications intended.
- (4) The products and product specifications described in this book are subject to change without notice for modification and/or improvement. At the final stage of your design, purchasing, or use of the products, therefore, ask for the most up-to-date Product Standards in advance to make sure that the latest specifications satisfy your requirements.
- (5) When designing your equipment, comply with the range of absolute maximum rating and the guaranteed operating conditions (operating power supply voltage and operating environment etc.). Especially, please be careful not to exceed the range of absolute maximum rating on the transient state, such as power-on, power-off and mode-switching. Otherwise, we will not be liable for any defect which may arise later in your equipment.
 - Even when the products are used within the guaranteed values, take into the consideration of incidence of break down and failure mode, possible to occur to semiconductor products. Measures on the systems such as redundant design, arresting the spread of fire or preventing glitch are recommended in order to prevent physical injury, fire, social damages, for example, by using the products.
- (6) Comply with the instructions for use in order to prevent breakdown and characteristics change due to external factors (ESD, EOS, thermal stress and mechanical stress) at the time of handling, mounting or at customer's process. When using products for which damp-proof packing is required, satisfy the conditions, such as shelf life and the elapsed time since first opening the packages.
- (7) This book may be not reprinted or reproduced whether wholly or partially, without the prior written permission of our company.