



# Series AMSRW-78-NZ

## Up to 12 Watt | DC-DC Switching Regulator



### FEATURES:

- 3 Pin SIP Package
- Pin-out compatible with LM78XX Linear Regulators
- Short Circuit Protection
- Non-Isolated Regulated Outputs
- Soft Start
- Operating temperature -40°C to +85°C
- Wide input range up to 8:1
- Very High Efficiency Up To 91%
- Low ripple and noise



### Models Single output

Model	Input Voltage (V)	Output Voltage (V)	Output Current max (mA)	Efficiency Vin Min (%)	Efficiency Vin Max (%)
AMSRW-783.3-NZ	9 ~ 72	3.3	500	82	75
AMSRW-7805-NZ	9 ~ 72	5	500	87	81
AMSRW-786.5-NZ	9 ~ 72	6.5	500	91	84
AMSRW-7812-NZ	17 ~ 72	12	500	93	89
AMSRW-7824-NZ	36 ~ 72	24	500	95	91
<b>90 Degree Angle Pins Version (L)</b>					
AMSRW-783.3L-NZ	9 ~ 72	3.3	500	82	75
AMSRW-7805L-NZ	9 ~ 72	5	500	87	81
AMSRW-7812L-NZ	17 ~ 72	12	500	93	89
AMSRW-7815L-NZ	20 ~ 72	15	500	94	90
AMSRW-7824L-NZ	36 ~ 72	24	500	95	91

### Input Specifications

Input Specifications	Nominal	Typical	Maximum	Units
Voltage range		See the table above		VDC
Quiescent Current	Vin= Nom, min load	1	5	mA
Short Circuit consumption	Vin = Nominal	0.72	1.2	W

### Output Specifications

Output Specifications	Conditions	Typical	Maximum	Units
Voltage accuracy	100% load	±2	±3	%
Short Circuit protection		Continuous.		
Short circuit restart		Auto recovery		
Output current limit			1.2	A
Dynamic load stability	10-100% load, 1 / 1.5ms		±100	mV
Line voltage regulation	Vin=(LL-HL) at full load	±0.4	±1	%
Load voltage regulation	10-100% load	±0.3	±0.6	%
Temperature coefficient	-40°C to +85°C ambient		±0.015	%/°C
Ripple & Noise	20MHz Bandwidth (10-100% load)	60		mV p-p
Maximum Capacitive Load			100	µF

### General Specifications

Input Specifications	Conditions	Minimum	Maximum	Units
Switching frequency	100% load	120	800	KHz
Operating temperature	With derating above 71°C	-40 to +85		°C
Storage temperature		-55 to +125		°C
Max Case temperature			100	°C
Cooling		Free air convection		
Humidity			95	%

### General Specifications (continued)

Input Specifications	Conditions	Minimum	Maximum	Units
Case material	Non-conductive black plastic (UL94V-0 rated)			
Weight	4			g
Dimensions (L x W x H)	0.45 X 0.35 X 0.69 inch		11.50 X 9.00 X 17.50 mm	
MTBF	> 3 500 000hrs (MIL-HDBK-217F, Ground Benign, t=+25°C)			
Soldering Temperature	1.5 mm from case for 10 sec		300	°C

NOTE: All specifications in this datasheet are measured at an ambient temperature of 25°C, humidity<75%, nominal input voltage and at rated output load unless otherwise specified.

### Pin Out Specifications

Pin	Single
1	+Vin
2	GND
3	+Vout

### Dimensions

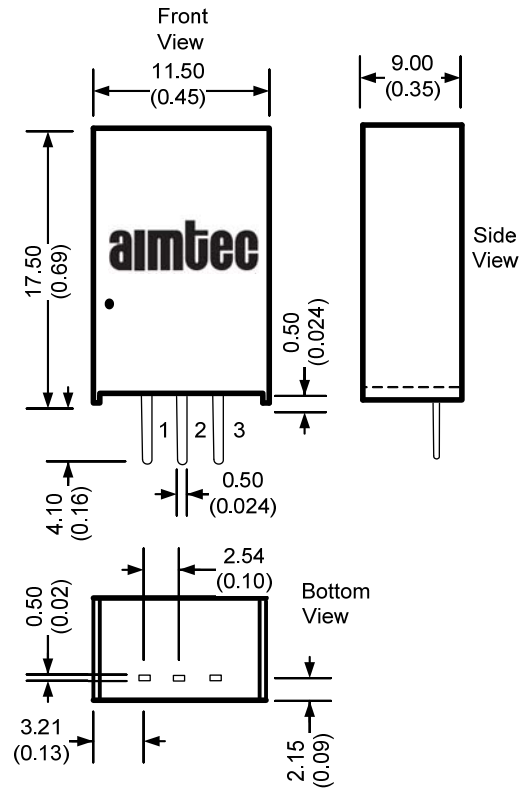

### Footprint

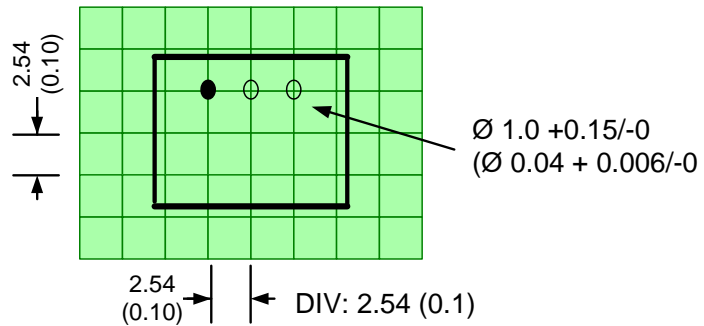

Dimensions are typical values: mm (inch)  
General Tolerance:  $\pm 0.25$  ( $\pm 0.01$ )  
Pin Tolerance:  $\pm 0.1$  ( $\pm 0.004$ )

### L Models

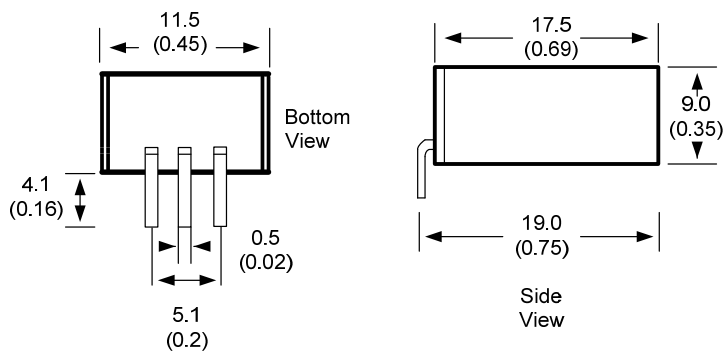

### Footprint

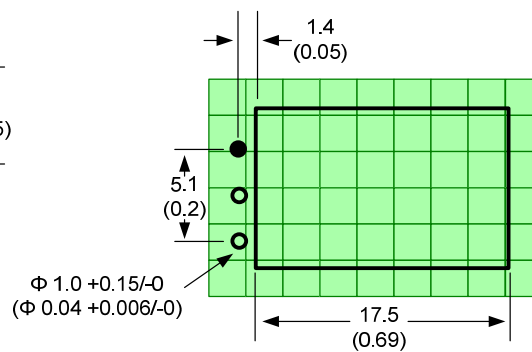

### Typical Application Circuit

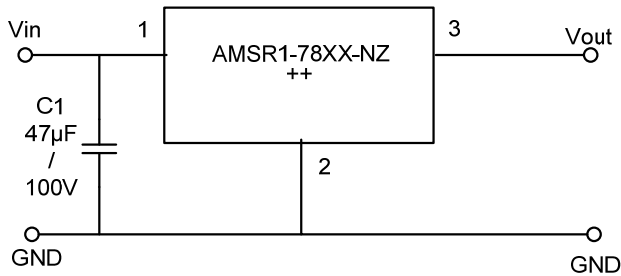

Abrupt low to high inputs may damage the regulator. C1 capacitor is required to filter potentially damaging voltage spikes if high voltage is applied. Typical value is (47µF / 100V). **NOTE: This part is not designed for parallel operation.**

### Recommended Circuits Conducted and Radiated Emissions

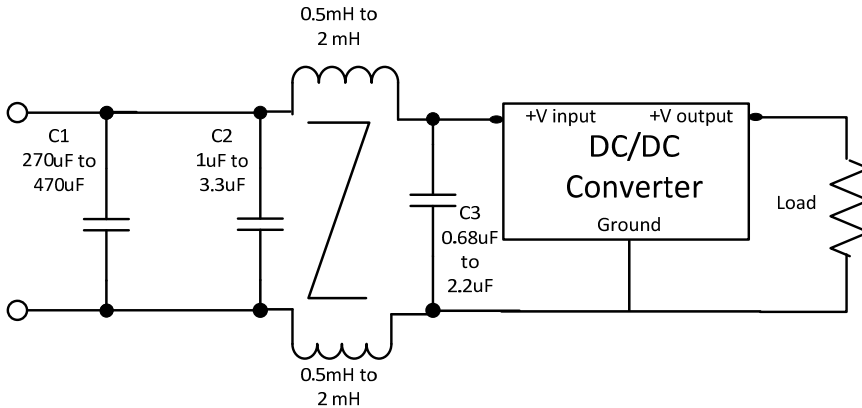

### Derating

Free Air Convection

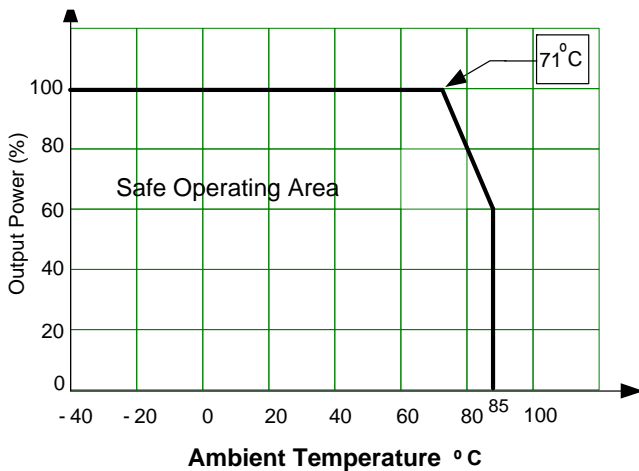

**NOTE:** 1. Datasheets are updated as needed and as such, specifications are subject to change without notice. Once printed or downloaded, datasheets are no longer controlled by Aimtec; refer to [www.aimtec.com](http://www.aimtec.com) for the most current product specifications. 2. Product labels shown, including safety agency certifications on labels, may vary based on the date manufactured. 3. Mechanical drawings and specifications are for reference only. 4. All specifications are measured at an ambient temperature of 25°C, humidity<75%, nominal input voltage and at rated output load unless otherwise specified. 5. Aimtec may not have conducted destructive testing or chemical analysis on all internal components and chemicals at the time of publishing this document. CAS numbers and other limited information are considered proprietary and may not be available for release. 6. This product is not designed for use in critical life support systems, equipment used in hazardous environments, nuclear control systems or other such applications which necessitate specific safety and regulatory standards other the ones listed in this datasheet. 7. Warranty is in accordance with Aimtec's standard Terms of Sale available at [www.aimtec.com](http://www.aimtec.com).