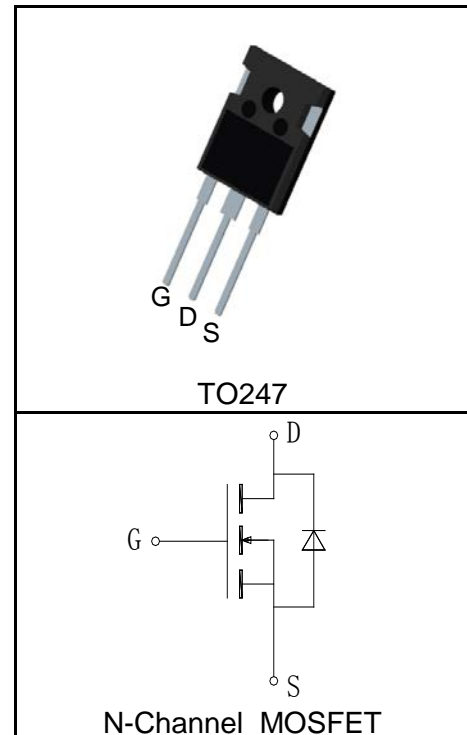

**Features**

- 100V/300A,  
 $R_{DS(ON)} = 3m\Omega(Typ.)@V_{GS}=10V$
- Ultra Low On-Resistance
- Exceptional dv/dt capability
- Fast Switching and Fully Avalanche Rated
- 100% avalanche tested
- 175°C Operating Temperature
- Lead Free and Green Devices Available (RoHS Compliant)

**Applications**

- High Efficiency Synchronous Rectification in SMPS
- High Speed Power Switching
- Power Supply

**Pin Description**

**Absolute Maximum Ratings**

Symbol	Parameter	Rating	Unit
<b>Common Ratings</b> ( $T_C=25^\circ C$ Unless Otherwise Noted)			
$V_{DSS}$	Drain-Source Voltage	100	V
$V_{GSS}$	Gate-Source Voltage	$\pm 25$	
$T_J$	Maximum Junction Temperature	175	$^\circ C$
$T_{STG}$	Storage Temperature Range	-55 to 175	$^\circ C$
$I_S$	Diode Continuous Forward Current	$T_C=25^\circ C$ 300	A
<b>Mounted on Large Heat Sink</b>			
$I_{DP}^{①}$	300 $\mu s$ Pulse Drain Current Tested	$T_C=25^\circ C$ 1200	A
$I_D^{②}$	Continuous Drain Current( $V_{GS}=10V$ )	$T_C=25^\circ C$ 300	A
		$T_C=100^\circ C$ 210	
$P_D$	Maximum Power Dissipation	$T_C=25^\circ C$ 600	W
		$T_C=100^\circ C$ 300	
$R_{\theta JC}$	Thermal Resistance-Junction to Case	0.25	$^\circ C/W$
$R_{\theta JA}$	Thermal Resistance-Junction to Ambient	50	$^\circ C/W$
<b>Drain-Source Avalanche Ratings</b>			
$E_{AS}^{③}$	Avalanche Energy, Single Pulsed	2450	mJ

**Electrical Characteristics** ( $T_C=25^\circ\text{C}$  Unless Otherwise Noted)

Symbol	Parameter	Test Condition	RU1H300Q			Unit
			Min.	Typ.	Max.	
<b>Static Characteristics</b>						
$BV_{DSS}$	Drain-Source Breakdown Voltage	$V_{GS}=0V, I_{DS}=250\mu A$	100			V
$I_{DSS}$	Zero Gate Voltage Drain Current	$V_{DS}=100V, V_{GS}=0V$			1	$\mu A$
		$T_J=125^\circ C$			30	
$V_{GS(th)}$	Gate Threshold Voltage	$V_{DS}=V_{GS}, I_{DS}=250\mu A$	2	3	4	V
$I_{GSS}$	Gate Leakage Current	$V_{GS}=\pm 25V, V_{DS}=0V$			$\pm 100$	nA
$R_{DS(ON)}^{(4)}$	Drain-Source On-state Resistance	$V_{GS}=10V, I_{DS}=90A$		3	4	m $\Omega$
<b>Diode Characteristics</b>						
$V_{SD}^{(4)}$	Diode Forward Voltage	$I_{SD}=90A, V_{GS}=0V$			1.2	V
$t_{rr}$	Reverse Recovery Time	$I_{SD}=90A, di_{SD}/dt=100A/\mu s$		145		ns
$Q_{rr}$	Reverse Recovery Charge			465		nC
<b>Dynamic Characteristics</b> <sup>(5)</sup>						
$R_G$	Gate Resistance	$V_{GS}=0V, V_{DS}=0V, F=1MHz$		1		$\Omega$
$C_{iss}$	Input Capacitance	$V_{GS}=0V, V_{DS}=50V, Frequency=1.0MHz$		12000		pF
$C_{oss}$	Output Capacitance			1450		
$C_{riss}$	Reverse Transfer Capacitance			650		
$t_{d(ON)}$	Turn-on Delay Time	$V_{DD}=50V, I_{DS}=90A, V_{GEN}=10V, R_G=4.7\Omega$		40		ns
$t_r$	Turn-on Rise Time			225		
$t_{d(OFF)}$	Turn-off Delay Time			145		
$t_f$	Turn-off Fall Time			285		
<b>Gate Charge Characteristics</b> <sup>(5)</sup>						
$Q_g$	Total Gate Charge	$V_{DS}=80V, V_{GS}=10V, I_{DS}=90A$		430		nC
$Q_{gs}$	Gate-Source Charge			85		
$Q_{gd}$	Gate-Drain Charge			115		

- Notes:
- ① Pulse width limited by safe operating area.
  - ② Calculated continuous current based on maximum allowable junction temperature. The package limitation current is 90A.
  - ③ Limited by  $T_{Jmax}$ ,  $I_{AS}=70A, V_{DD}=60V, R_G=50\Omega$ , Starting  $T_J=25^\circ C$ .
  - ④ Pulse test; Pulse width  $\leq 300\mu s$ , duty cycle  $\leq 2\%$ .
  - ⑤ Guaranteed by design, not subject to production testing.

**Ordering and Marking Information**

<b>Device</b>	<b>Marking</b>	<b>Package</b>	<b>Packaging</b>	<b>Quantity</b>	<b>Reel Size</b>	<b>Tape width</b>
RU1H300Q	RU1H300Q	TO247	Tube	30	-	-

**Typical Characteristics**

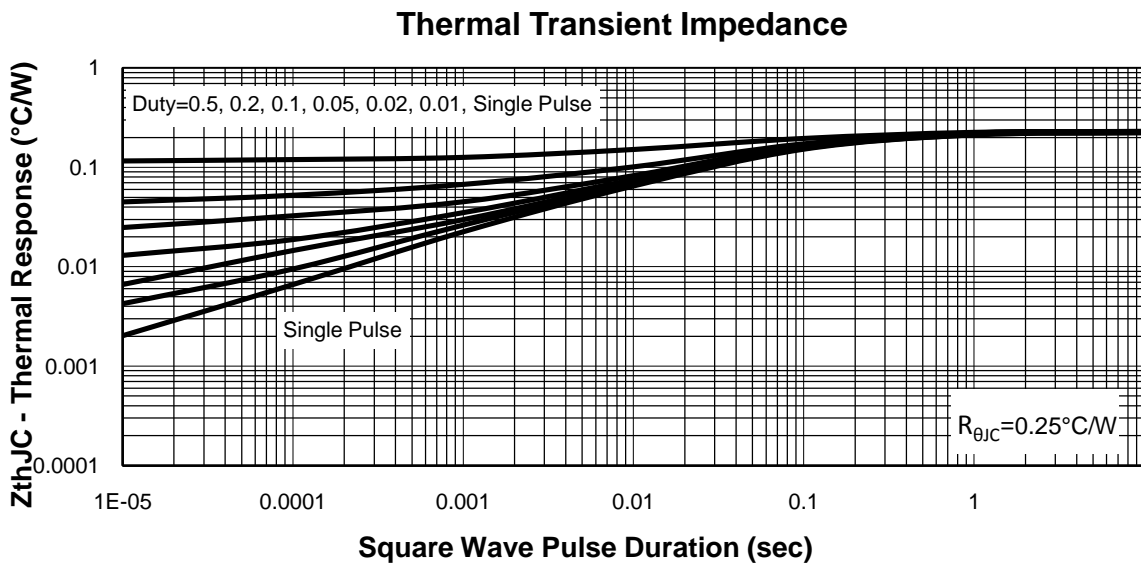
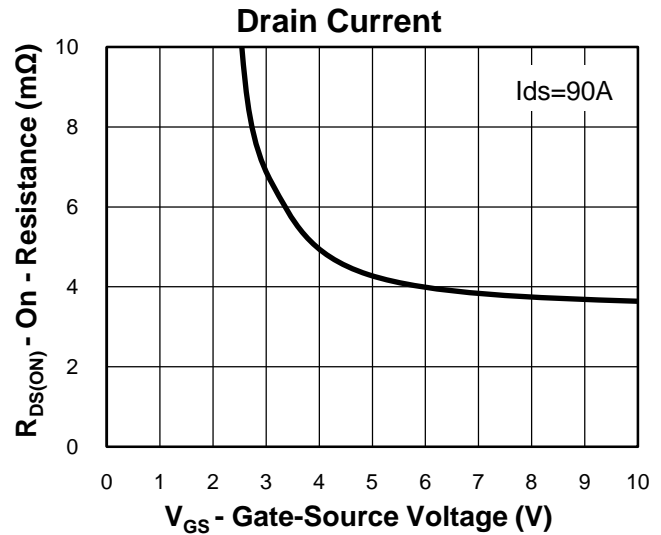
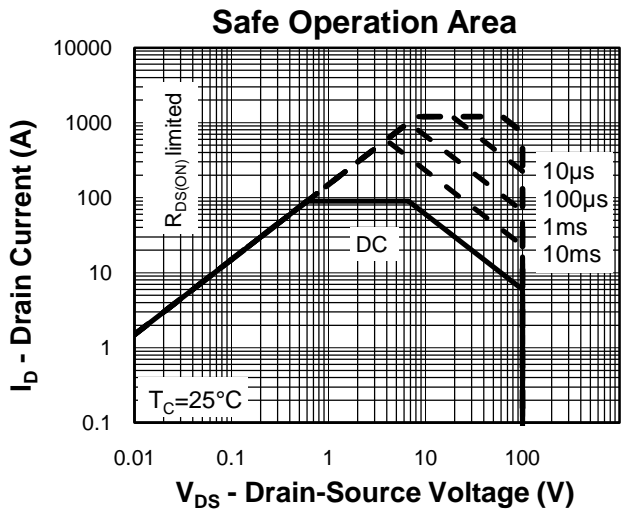
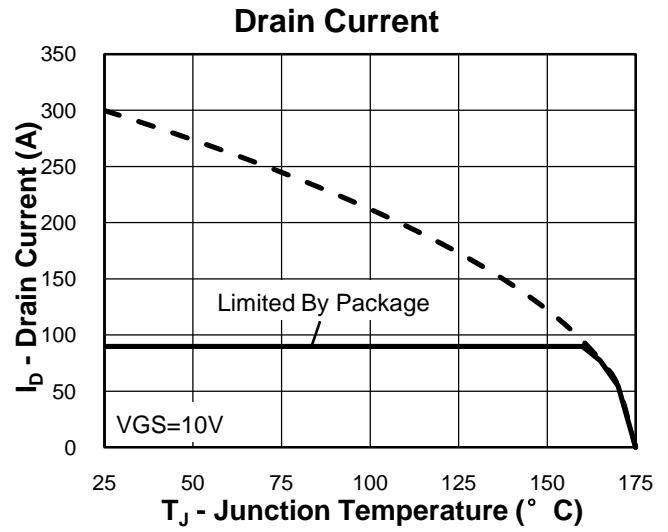
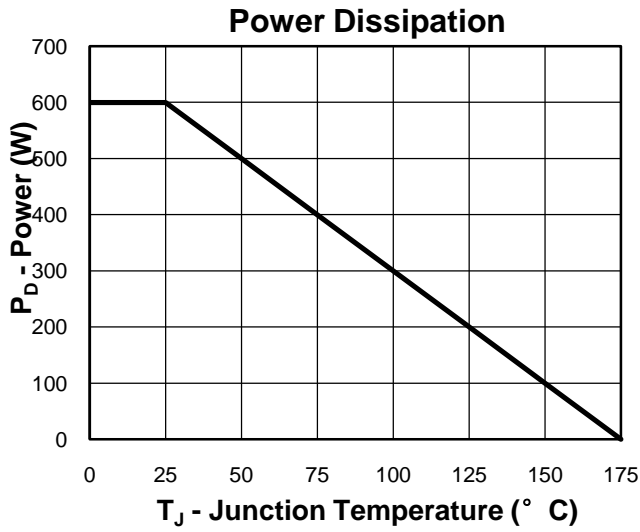

**Typical Characteristics**

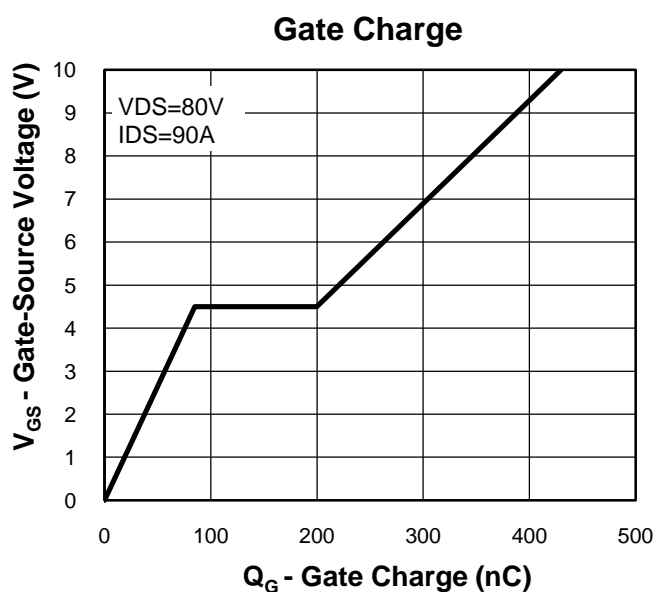
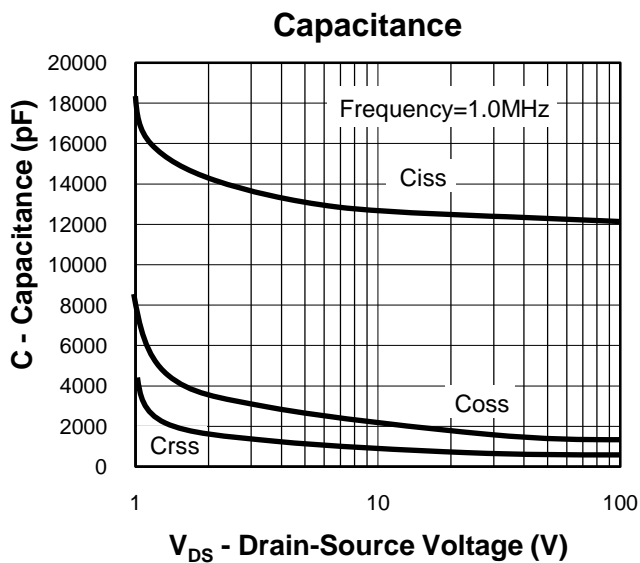
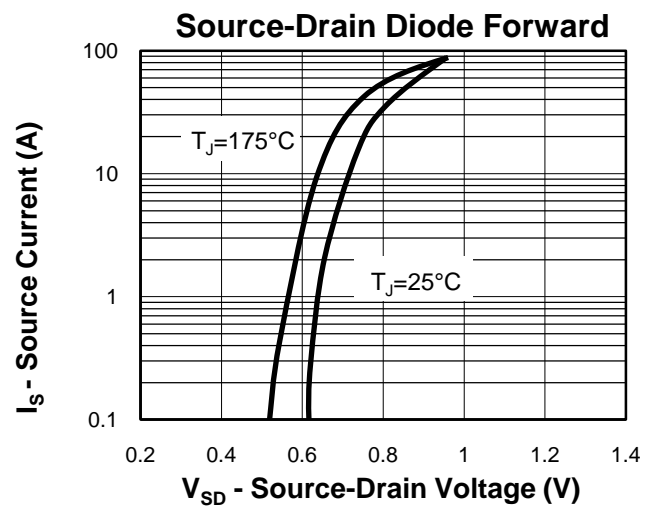
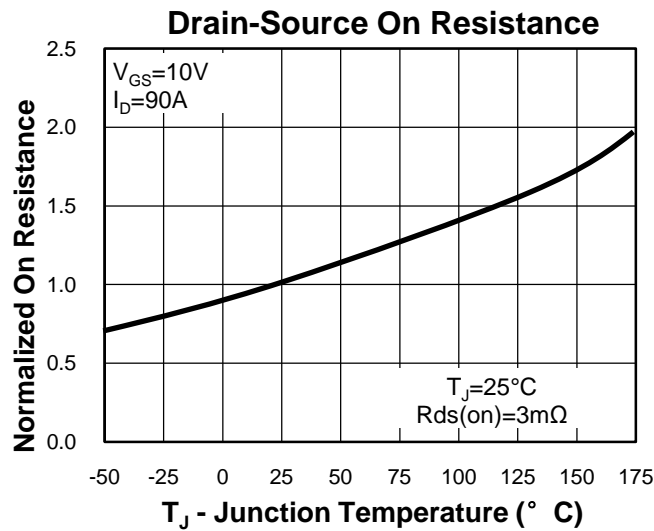
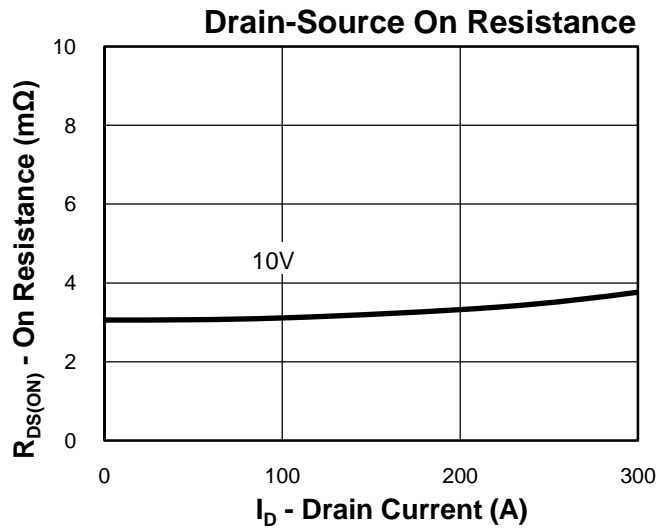
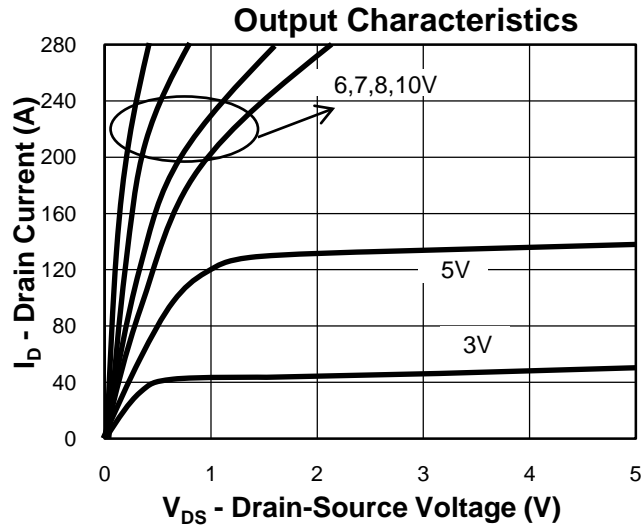

**Avalanche Test Circuit and Waveforms**

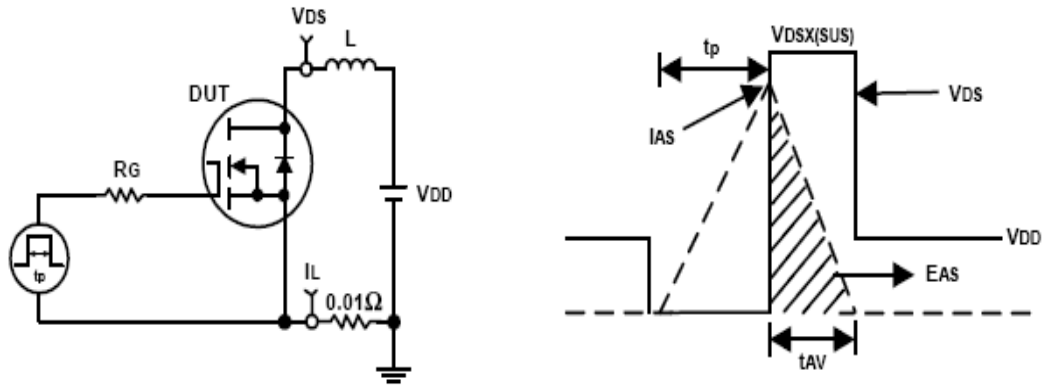

**Switching Time Test Circuit and Waveforms**

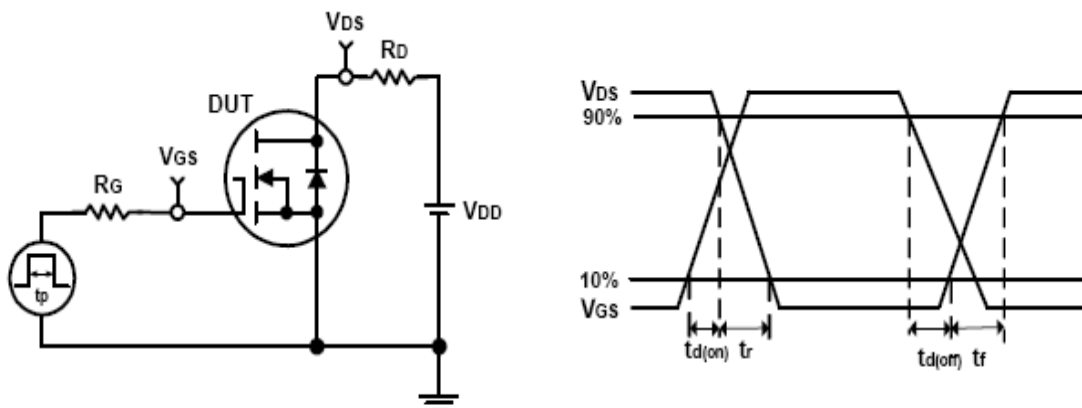

**Package Information**

**TO247**

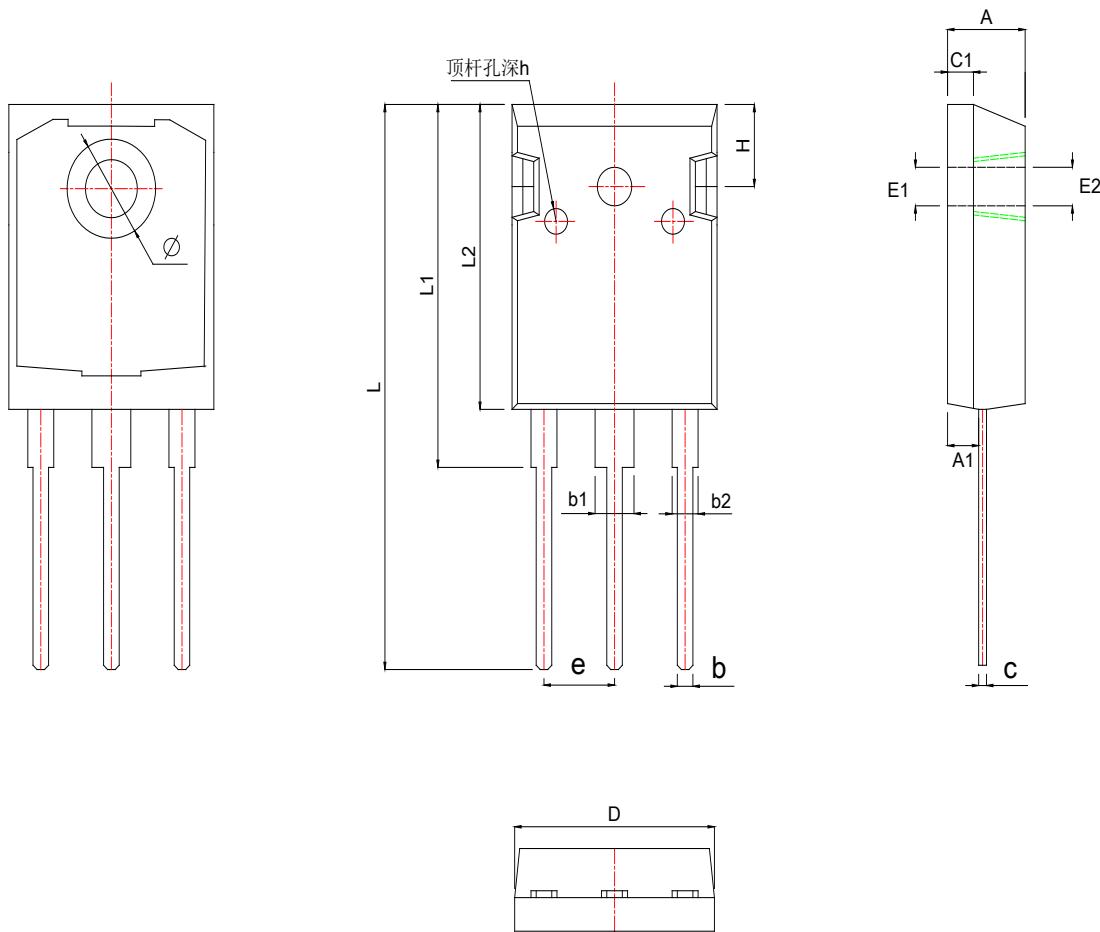

SYMBOL	MM			INCH		
	MIN	NOM	MAX	MIN	NOM	MAX
A	4.850	5.000	5.150	0.191	0.197	0.203
A1	2.200	2.400	2.600	0.087	0.094	0.102
b	1.000	1.200	1.400	0.039	0.047	0.055
b1	2.800	3.000	3.200	0.110	0.118	0.126
b2	1.800	2.000	2.200	0.071	0.079	0.087
c	0.500	0.600	0.700	0.020	0.024	0.028
c1	1.900	2.000	2.100	0.075	0.079	0.083
D	15.450	15.600	15.750	0.608	0.614	0.620
E1	3.500REF			0.138REF		
E2	3.600REF			0.142REF		
L	40.900	41.100	41.300	1.610	1.618	1.626
L1	24.800	24.950	25.100	0.976	0.982	0.988
L2	20.300	20.450	20.600	0.799	0.805	0.811
$\Phi$	7.10	7.20	7.30	0.280	0.283	0.287
e	5.450TYP			0.215TYP		
H	5.980REF			0.235REF		
h	0.000	0.150	0.300	0.000	0.006	0.012

**Customer Service****Worldwide Sales and Service:**

Sales@ruichips.com

**Technical Support:**

Technical@ruichips.com

**Investor Relations Contacts:**

Investor@ruichips.com

**Marcom Contact:**

Marcom@ruichips.com

**Editorial Contact:**

Editorial@ruichips.com

**HR Contact:**

HR@ruichips.com

**Legal Contact:**

Legal@ruichips.com

**Shen Zhen RUICHIPS Semiconductor CO., LTD**Room 501, the 5floor An Tong Industrial Building,  
NO.207 Mei Hua Road Fu Tian Area Shen Zhen City, CHINA**TEL:** (86-755) 8311-5334**FAX:** (86-755) 8311-4278**E-mail:** Sales-SZ@ruichips.com