



■ Features

- Universal AC input / Full range (up to 305VAC)
- Built-in active PFC function
- High efficiency up to 90.5%
- Protections: Short circuit / Over current / Over voltage / Over temperature
- Cooling by free air convection
- Fully isolated plastic case
- Fully encapsulated with IP67 level
- Class II power unit, no FG
- Suitable for dry / damp / wet locations
- No load power consumption < 0.15W
- 5 years warranty

■ Applications

- Indoor LED lighting
- LED decorative lighting
- LED architecture lighting
- Moving sign
- Tunnel lighting

■ Description

NPF-120 is one 120W waterproof single-output LED power supply series. It adopts the universal input range from 90VAC to 305VAC and incorporates the built-in PFC function. The enclosure design is a 94V-0 flame retardant plastic case. The interior is fully potted with silicone that enhances the heat dissipation and allows the power supply to meet the anti-vibration demand up to 5G; it also thus conforms to IP67 level, enabling NPF-120 to be used in a highly dusty and highly humid harsh environment.

Providing a high efficiency up to 90.5% and a low no load power consumption below 0.15W, NPF-120 can meet the energy saving demand for the new generation LED lighting. The class II design (no FG) and the double insulation weather-resistant cable (SJTW) on the input side make it convenient for users to flexibly install on various types of lighting systems. The entire series can operate under the temperature between -40~+70°C and comply with the relevant global lighting safety certification.

■ Model Encoding

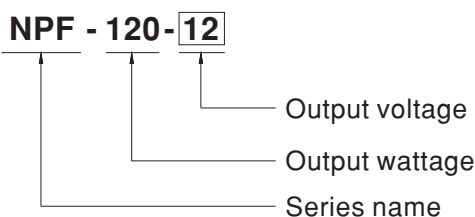



SPECIFICATION

MODEL		NPF-120-12	NPF-120-15	NPF-120-20	NPF-120-24	NPF-120-30	NPF-120-36	NPF-120-42	NPF-120-48	NPF-120-54	
OUTPUT	DC VOLTAGE	12V	15V	20V	24V	30V	36V	42V	48V	54V	
	CONSTANT CURRENT REGION	7.2 ~ 12V	9 ~ 15V	12 ~ 20V	14.4 ~ 24V	18 ~ 30V	21.6 ~ 36V	25.2 ~ 42V	28.8 ~ 48V	32.4 ~ 54V	
	RATED CURRENT	10A	8A	6A	5A	4A	3.4A	2.9A	2.5A	2.3A	
	RATED POWER	120W	120W	120W	120W	120W	122.4W	121.8W	120W	124.2W	
	RIPPLE & NOISE (max.) Note.2	150mVp-p	150mVp-p	150mVp-p	150mVp-p	200mVp-p	200mVp-p	250mVp-p	250mVp-p	350mVp-p	
	VOLTAGE TOLERANCE Note.3	±4.0%	±4.0%	±4.0%	±4.0%	±3.0%	±2.0%	±1.0%	±1.0%	±1.0%	
	LINE REGULATION	±0.5%	±0.5%	±0.5%	±0.5%	±0.5%	±0.5%	±0.5%	±0.5%	±0.5%	
	LOAD REGULATION	±2.0%	±1.5%	±1.0%	±0.5%	±0.5%	±0.5%	±0.5%	±0.5%	±0.5%	
	SETUP, RISE TIME Note.4	500ms, 80ms at 95% load 230VAC / 115VAC									
HOLD UP TIME (Typ.)	16ms/230VAC		16ms/115VAC at full load								
INPUT	VOLTAGE RANGE	90 ~ 305VAC		127 ~ 431VDC							
	FREQUENCY RANGE	47 ~ 63Hz									
	POWER FACTOR (Typ.)	PF>0.97/115VAC, PF>0.96/230VAC, PF>0.94/277VAC at full load (Please refer to "Power Factor Characteristic" curve)									
	TOTAL HARMONIC DISTORTION	THD< 20% when output loading ≥ 60% at 115VAC/230VAC input and output loading ≥ 75% at 277VAC input									
	EFFICIENCY (Typ.)	89%	89%	90%	90.5%	89.5%	90%	90%	90%	90%	90.5%
	AC CURRENT (Typ.)	1.3A / 115VAC		0.65A / 230VAC		0.55A / 277VAC					
	INRUSH CURRENT(Typ.)	COLD START 60A(twidth=520μs measured at 50% Ipeak) at 230VAC									
	MAX. NO. of PSUs on 16A CIRCUIT BREAKER	4 units (circuit breaker of type B) / 6 units (circuit breaker of type C) at 230VAC									
	LEAKAGE CURRENT	<0.25mA / 277VAC									
PROTECTION	OVER CURRENT	95 ~ 108% Protection type : Constant current limiting, recovers automatically after fault condition is removed									
	SHORT CIRCUIT	Hiccup mode, recovers automatically after fault condition is removed									
	OVER VOLTAGE	15 ~ 17V	17.5 ~ 21V	23 ~ 27V	28 ~ 34V	34 ~ 40V	41 ~ 46V	46 ~ 54V	54 ~ 60V	59 ~ 66V	
	OVER TEMPERATURE	Shut down o/p voltage, re-power on to recover									
ENVIRONMENT	WORKING TEMP.	-40 ~ +70°C (Refer to "Derating Curve")									
	WORKING HUMIDITY	20 ~ 95% RH non-condensing									
	STORAGE TEMP., HUMIDITY	-40 ~ +80°C, 10 ~ 95% RH									
	TEMP. COEFFICIENT	±0.03%/°C (0 ~ 50°C)									
	VIBRATION	10 ~ 500Hz, 5G 12min./1cycle, period for 72min. each along X, Y, Z axes									
SAFETY & EMC	SAFETY STANDARDS	UL8750, CSA C22.2 No. 250.13-12, ENEC EN61347-1, EN61347-2-13, EN62384 independent, IP67 approved; Design refer to EN60335-1									
	WITHSTAND VOLTAGE	I/P-O/P:3.75KVAC									
	ISOLATION RESISTANCE	I/P-O/P:100M Ohms / 500VDC / 25°C / 70% RH									
	EMC EMISSION	Compliance to EN55015, EN61000-3-2 Class C (≥60% load) ; EN61000-3-3									
	EMC IMMUNITY	Compliance to EN61000-4-2,3,4,5,6,8,11; EN61547, light industry level(surge 2KV), criteria A									
OTHERS	MTBF	295.1K hrs min. MIL-HDBK-217F (25°C)									
	DIMENSION	191*63*37.5mm (L*W*H)									
	PACKING	0.97Kg; 15pcs/15.6Kg/0.87CUFT									
NOTE	<p>1. All parameters NOT specially mentioned are measured at 230VAC input, rated load and 25°C of ambient temperature.</p> <p>2. Ripple & noise are measured at 20MHz of bandwidth by using a 12" twisted pair-wire terminated with a 0.1uf & 47uf parallel capacitor.</p> <p>3. Tolerance : includes set up tolerance, line regulation and load regulation.</p> <p>4. Length of set up time is measured at cold first start. Turning ON/OFF the power supply may lead to increase of the set up time.</p>										

■ **Block Diagram**

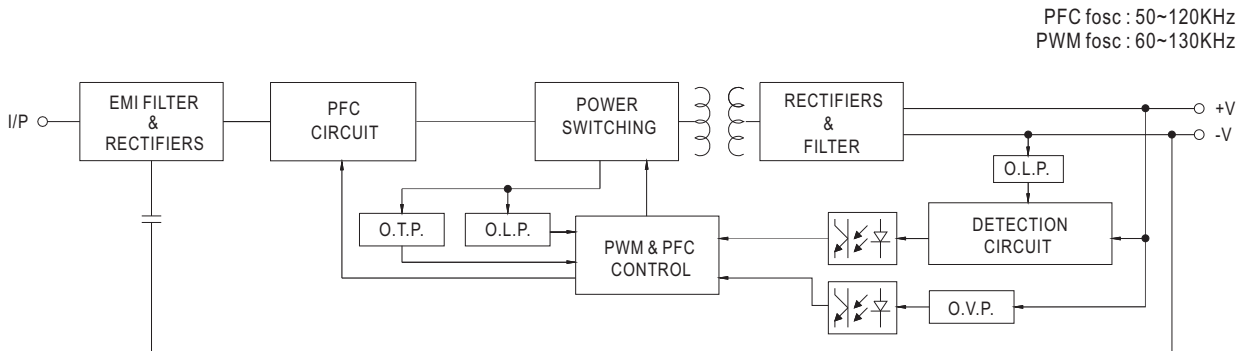

■ **Derating Curve**

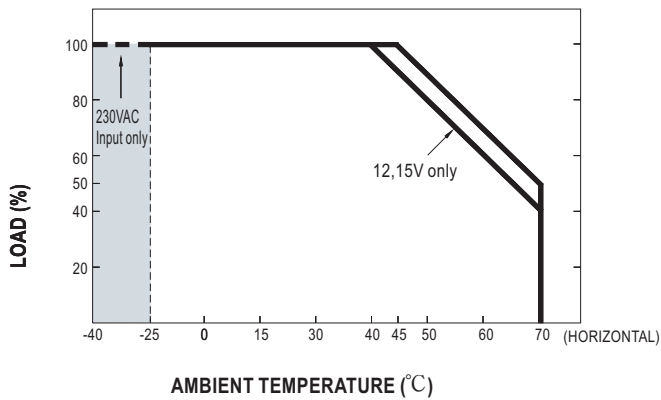

■ **Static Characteristics**

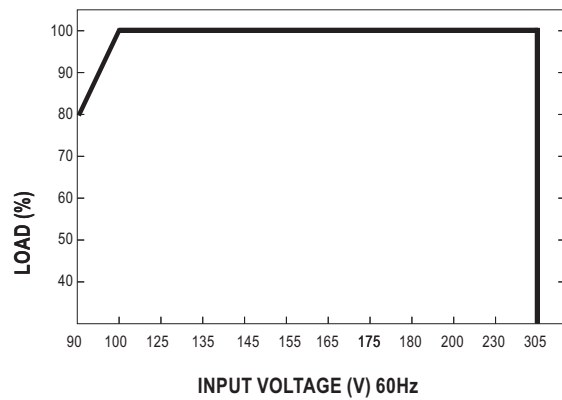

■ **Power Factor Characteristic**

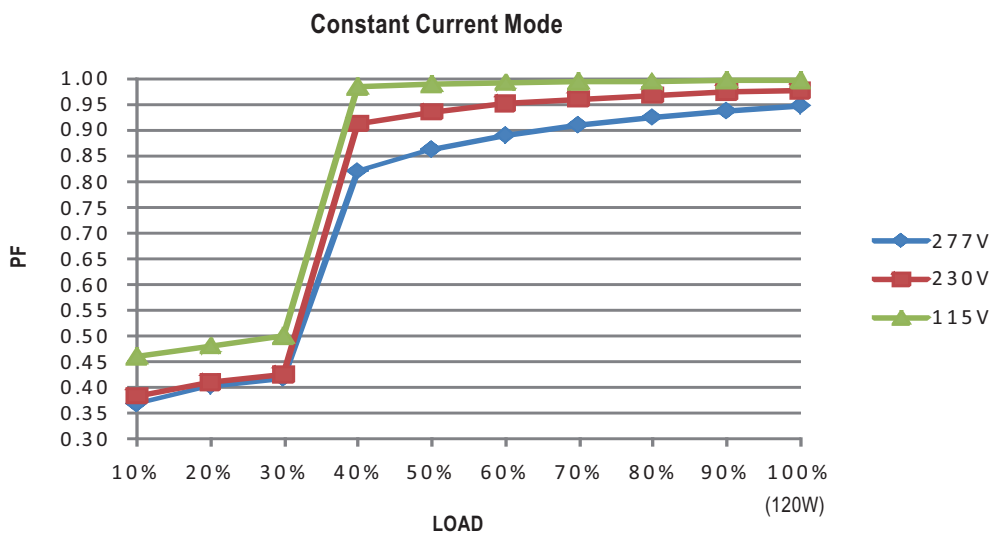

EFFICIENCY vs LOAD (48V Model)

NPF-120 series possess superior working efficiency that up to 90% can be reached in field applications.

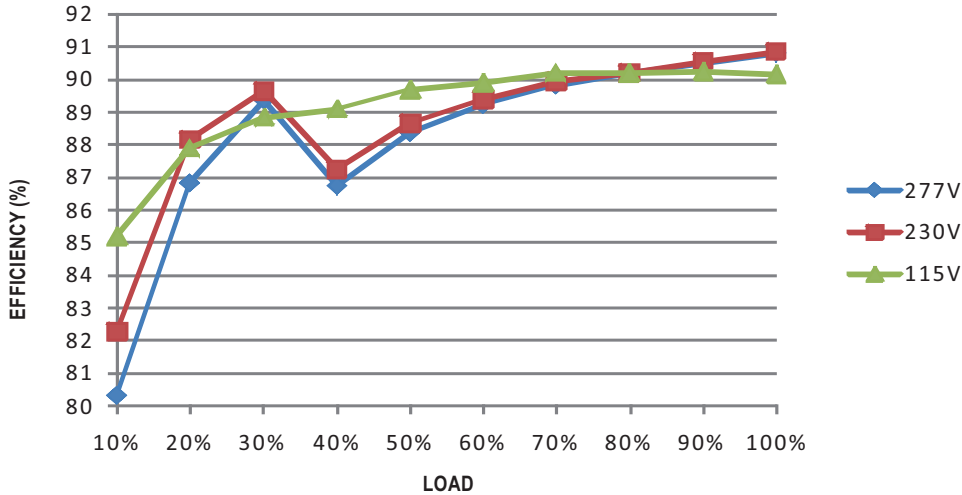

DRIVING METHODS OF LED MODULE

There are two major kinds of LED drive method, "direct drive" and "with LED driver".

A typical LED power supply may either work in "constant voltage mode (CV)" or "constant current mode (CC)" to drive the LEDs.

Mean Well's LED power supply with CV+ CC characteristic can be operated at both CV mode (with LED driver, at area (A) and CC mode (direct drive, at area (B)).

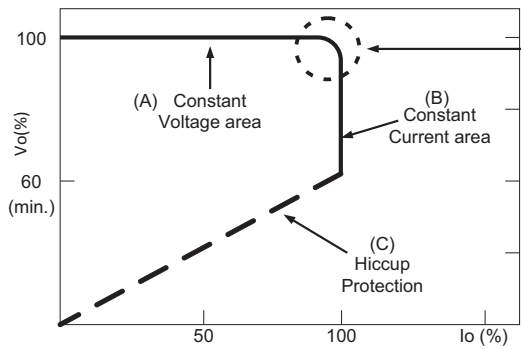

Typical LED power supply I-V curve

In the constant current region, the highest voltage at the output of the driver depends on the configuration of the end systems.

Should there be any compatibility issues, please contact MEAN WELL.

■ Mechanical Specification

Case No. PWM-120

Unit:mm

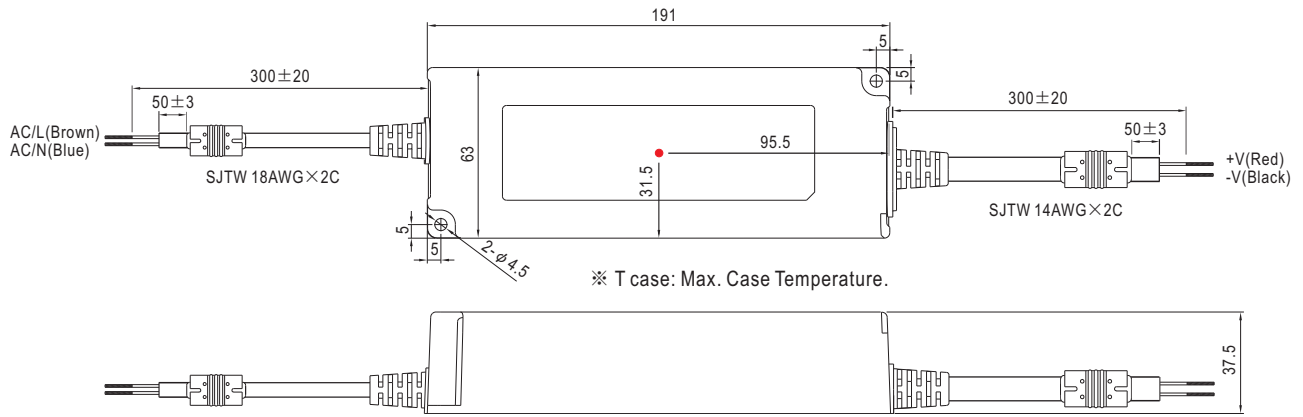

■ Recommend Mounting Direction



■ Installation Manual

Please refer to : <http://www.meanwell.com/webnet/search/InstallationSearch.html>