

PLEASE CHECK WWW.MOLEX.COM FOR LATEST PART INFORMATION

Part Number: [0877823007](#)
Status: **Active**
Overview: miniDIMM
Description: 0.60mm Pitch miniDIMM DDR3 Socket, Vertical, Surface Mount, 0.76µm Gold (Au) over Nickel, 1.5V, with Pick and Place Cover, 244 Circuits, Type C Tray, Lead-Free

Documents:

[3D Model](#) [Application Specification AS-87782-001 \(PDF\)](#)
[Drawing \(PDF\)](#) [RoHS Certificate of Compliance \(PDF\)](#)
[Product Specification PS-87782-027 \(PDF\)](#)

Agency Certification

CSA LR19980
 UL E29179

General

Product Family Memory Module Sockets
 Series [87782](#)
 Comments Latches in Off-White ColorWith Cap
 Component Type Socket
 Electrical Model Yes
 JEDEC Outline MO-244
 Overview [miniDIMM](#)
 Product Name MiniDIMM
 UPC 883906426231

Physical

Circuits (Loaded) 244
 Color - Resin Black
 Durability (mating cycles max) 25
 Entry Angle Vertical (Top Entry)
 Flammability 94V-0
 Keying to Mating Part Yes
 Material - Metal Copper Alloy
 Material - Plating Mating Gold
 Material - Plating Termination Tin
 Material - Resin High Temperature Thermoplastic
 Net Weight 7.363/g
 PCB Locator Yes
 PCB Retention Yes
 Packaging Type Tray
 Pitch - Mating Interface 0.60mm
 Pitch - Termination Interface 0.60mm
 Plating min - Mating 0.762µm
 Plating min - Termination 2.540µm
 Temperature Range - Operating -55°C to +85°C
 Termination Interface: Style Surface Mount

Electrical

Current - Maximum per Contact 1.0A
 Voltage - Maximum 30V (RMS)
 Voltage Key 1.5V

Solder Process Data

Duration at Max. Process Temperature (seconds) 005
 Lead-free Process Capability SMC&WAVE
 Max. Cycles at Max. Process Temperature 002
 Process Temperature max. C 260

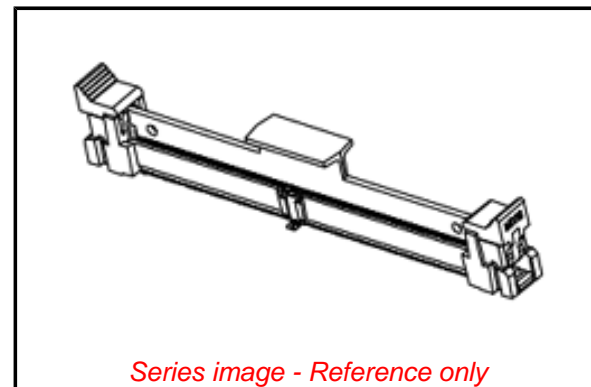

Series image - Reference only

EU ELV

Not Relevant

EU RoHS

Compliant

REACH SVHC

Contains SVHC(2014 December 17): No

Halogen-Free

Status

Not Low-Halogen

Need more information on product environmental compliance?

Email productcompliance@molex.com
 Please visit the [Contact Us](#) section for any non-product compliance questions.

China ROHS

ELV

Green Image

Not Relevant

Search Parts in this Series

[87782](#) Series

Mates With

JEDEC MO-244 Modules

Material Info

Reference - Drawing Numbers

Application Specification	AS-87782-001
Electrical Model Document	EE-87782-001, EE-87782-002, EE-87782-003, EE-87782-007
Product Specification	PS-87782-027
S-Parameter Model	SP-87782-001, SP-87782-007
Sales Drawing	SD-87782-001

This document was generated on 06/23/2015

PLEASE CHECK WWW.MOLEX.COM FOR LATEST PART INFORMATION