

### PROTECTION PRODUCTS

#### Description

RailClamp® 3324P provides ESD protection for high-speed data interfaces. It features a high maximum ESD withstand voltage of  $\pm 17\text{kV}$  contact and  $\pm 20\text{kV}$  air discharge per IEC 61000-4-2. RClamp3324P is designed to minimize both the ESD peak clamping and the TLP clamping. Package inductance is reduced at each pin resulting in lower peak ESD clamping voltage. The dynamic resistance is among the industry's lowest at 0.15 Ohms (typical). Maximum capacitance on each line to ground is 0.65pF allowing the RClamp3324P to be used in applications operating in excess of 5GHz without signal attenuation. Each device will protect up to four lines (two high-speed pairs) and are qualified to AEC-Q100, Grade 1 ( $-40$  to  $+125$  °C) for automotive applications. .

RClamp3324P is in a 10-pin SGP2510P8 package measuring 2.5 x 1.0mm with a nominal height of 0.60mm. The leads have a nominal pin-to-pin pitch of 0.50mm. Flow-through package design simplifies PCB layout and maintains signal integrity on high-speed lines.

The combination of low peak ESD clamping, low dynamic resistance, and innovative package design enables this device to provide the highest level of ESD protection for applications such as USB 3.0, eSATA, and DisplayPort.

#### Nominal Dimension

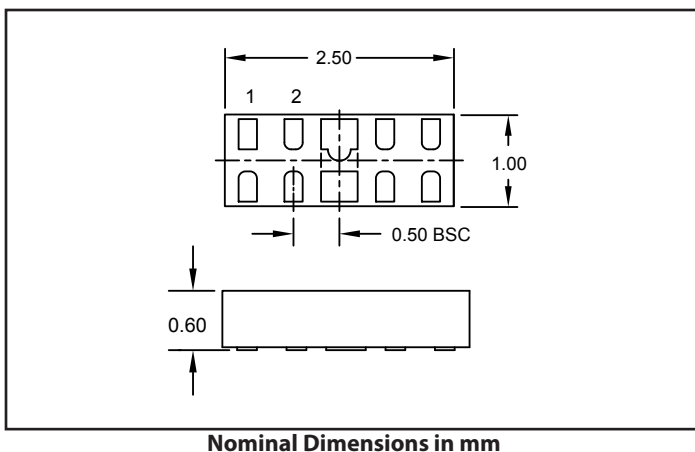

#### Features

- Transient Protection to
  - ♦ IEC 61000-4-2 (ESD) 20kV (Air), 17kV (Contact)
  - ♦ IEC 61000-4-4 (EFT) 4kV (5/50ns)
  - ♦ IEC 61000-4-5 (Lightning) 4.5A (8/20 $\mu$ s)
  - ♦ ISO-10605 (ESD) 15kV (Air), 12kV (Contact)
- Qualified to AEC-Q100, Grade 1
- Package design optimized for high speed layout
- Protects four high-speed data lines
- Working Voltage: 3.3V
- Low Capacitance: 0.65 pF maximum (I/O to GND)
- Dynamic Resistance: 0.15 Ohms (Typ)
- Solid-State Silicon-Avalanche Technology

#### Mechanical Characteristics

- SGP2510P8 Package
- Pb-Free, Halogen Free, RoHS/WEEE Compliant
- Nominal Dimensions: 2.5 x 1.0 x 0.60 mm
- Lead Finish: NiPdAu
- Molding Compound Flammability Rating: UL 94V-0
- Marking : Marking Code + Date Code
- Packaging : Tape and Reel

#### Applications

- USB 3.0
- Automotive Applications
- Industrial Equipment
- Digital Visual Interface
- LVDS Interfaces
- eSATA

#### Functional Schematic

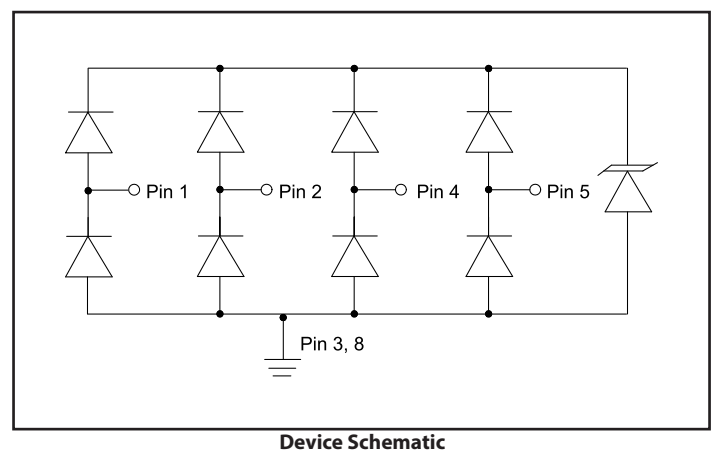

## Absolute Maximum Rating

Rating	Symbol	Value	Units
Peak Pulse Current (tp = 8/20μs)	I <sub>PP</sub>	4.5	A
ESD per IEC 61000-4-2 (Contact) <sup>(1)</sup> ESD per IEC 61000-4-2 (Air) <sup>(1)</sup>	V <sub>ESD</sub>	±17 ±20	kV
ESD per ISO-10605 (Contact) <sup>(2)</sup> ESD per ISO-10605 (Air) <sup>(2)</sup>	V <sub>ESD</sub>	±12 ±15	kV
Operating Temperature	T <sub>J</sub>	-40 to +125	°C
Storage Temperature	T <sub>STG</sub>	-55 to +150	°C

## Electrical Characteristics (T=25°C unless otherwise specified)

Parameter	Symbol	Conditions	Min.	Typ.	Max.	Units
Reverse Stand-Off Voltage	V <sub>RWM</sub>	-40°C to 125°C Any I/O pin to GND			3.3	V
Trigger Voltage	V <sub>TRIG</sub>	tp = 0.2/100ns (TLP) Any I/O pin to GND		8		V
Reverse Leakage Current	I <sub>R</sub>	V <sub>RWM</sub> = 3.3V	T = 25°C	0.01	0.05	μA
			T = 125°C		0.150	μA
Clamping Voltage <sup>(3)</sup>	V <sub>C</sub>	I <sub>PP</sub> = 1A, tp = 8/20μs, Any I/O pin to GND		2.5	3.5	V
Clamping Voltage <sup>(3)</sup>	V <sub>C</sub>	I <sub>PP</sub> = 4.5A, tp = 8/20μs, Any I/O pin to GND		3.5	4.5	V
ESD Clamping Voltage <sup>(4)</sup>	V <sub>C</sub>	I <sub>PP</sub> = 4A, tp = 0.2/100ns (TLP) Any I/O pin to GND		3.5		V
ESD Clamping Voltage <sup>(4)</sup>	V <sub>C</sub>	I <sub>PP</sub> = 16A, tp = 0.2/100ns (TLP) Any I/O pin to GND		5.3		V
Dynamic Resistance <sup>(4), (5)</sup>	R <sub>DYN</sub>	tp = 0.2/100ns (TLP) Any I/O pin to GND		0.15		Ohms
Junction Capacitance	C <sub>J</sub>	V <sub>R</sub> = 0V, f = 1MHz Any I/O pin to GND		0.60	0.65	pF
		V <sub>R</sub> = 0V, f = 1MHz Between I/O Pins		0.30	0.40	pF

Notes:

(1): ESD Gun return path to Ground Reference Plane (GRP)

(2): ESD Gun return path to Horizontal Coupling Plane (HCP); Test conditions: 150pF, 330pF, 330Ω.

(3): Measured using an 8/20us constant current source.

(4): Transmission Line Pulse Test (TLP) Settings: tp = 100ns, tr = 0.2ns, I<sub>TLP</sub> and V<sub>TLP</sub> averaging window: t<sub>1</sub> = 70ns to t<sub>2</sub> = 90ns.

(5): Dynamic resistance calculated from I<sub>TLP</sub> = 4A to I<sub>TLP</sub> = 16A

# Typical Characteristics

### ESD Clamping (+8kV Contact per IEC 61000-4-2)

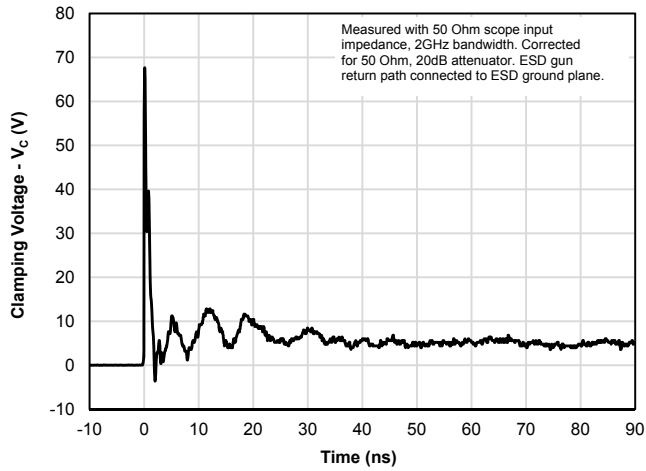

### ESD Clamping (-8kV Contact per IEC 61000-4-2)

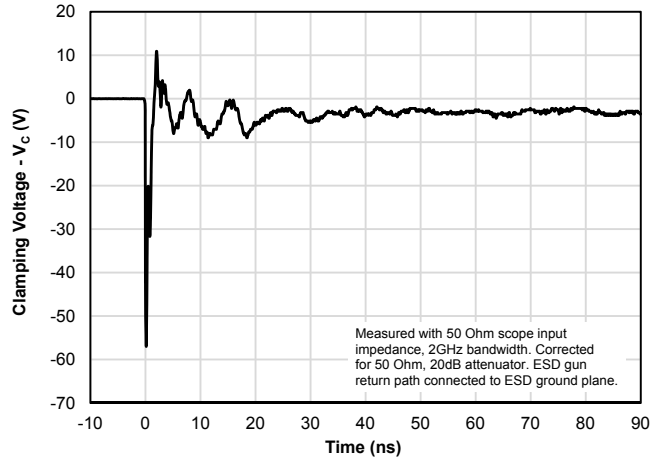

### ESD Clamping (+8kV Contact per ISO-10605)

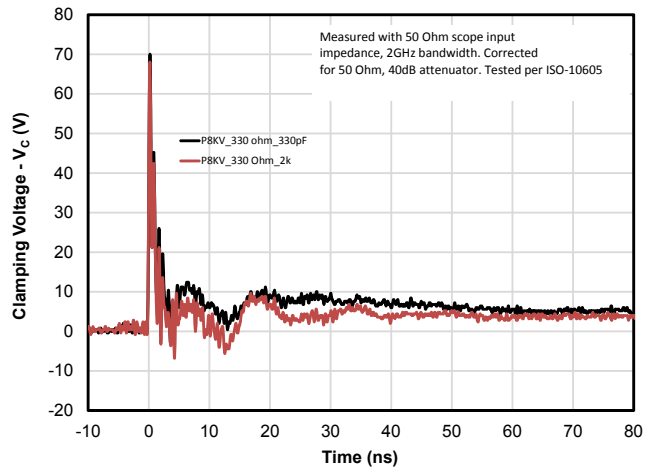

### ESD Clamping (-8kV Contact per ISO-10605)

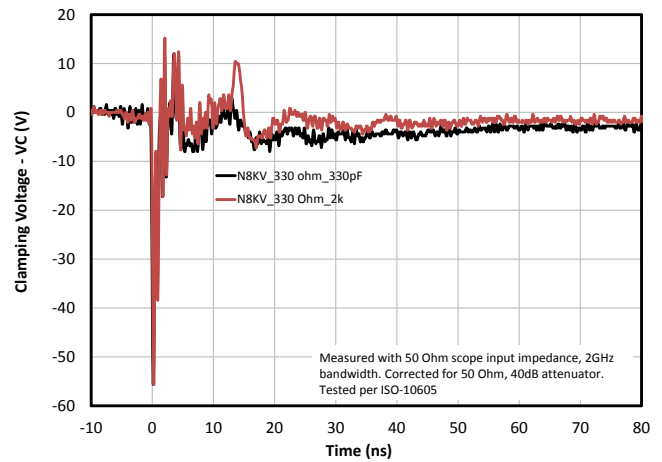

### TLP Curve (Positive Pulse)

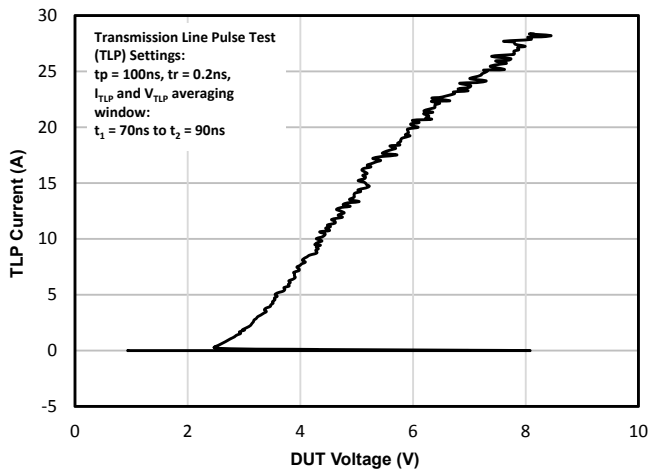

### TLP Curve (Negative Pulse)

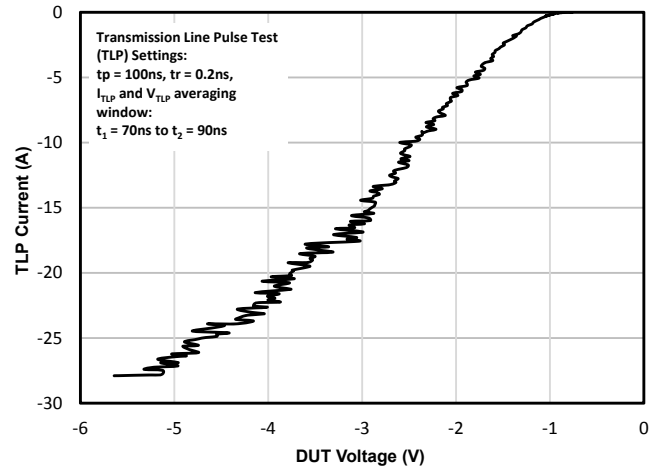

# Typical Characteristics (Continued)

### Clamping Voltage vs. Peak Pulse Current (tp=8/20us)

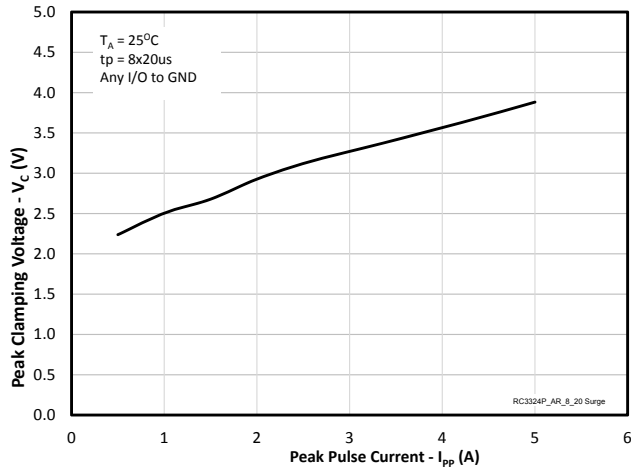

### Reverse Leakage Current (IR) vs. Temperature

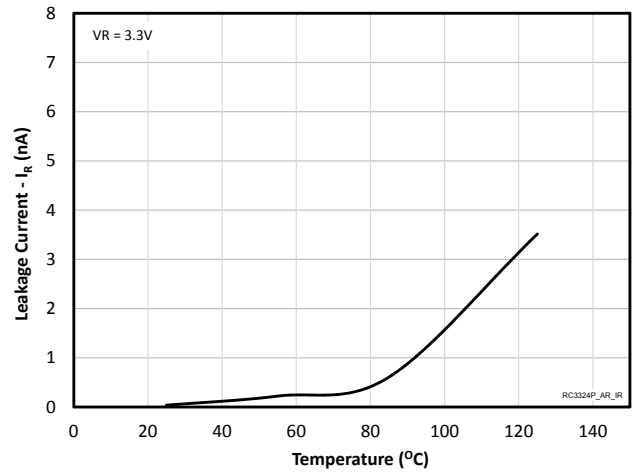

### Capacitance vs. Reverse Voltage

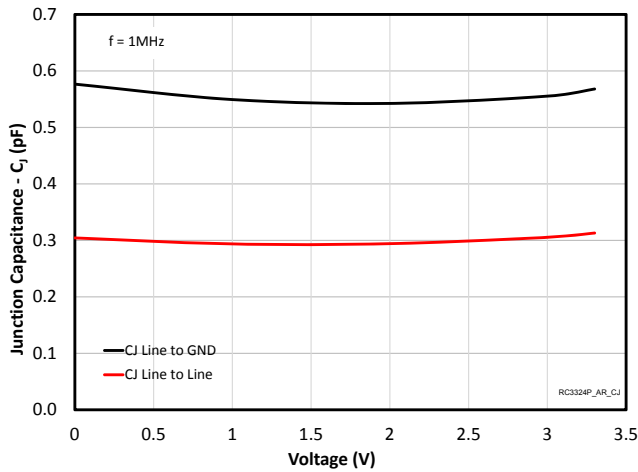

### Capacitance vs. Temperature

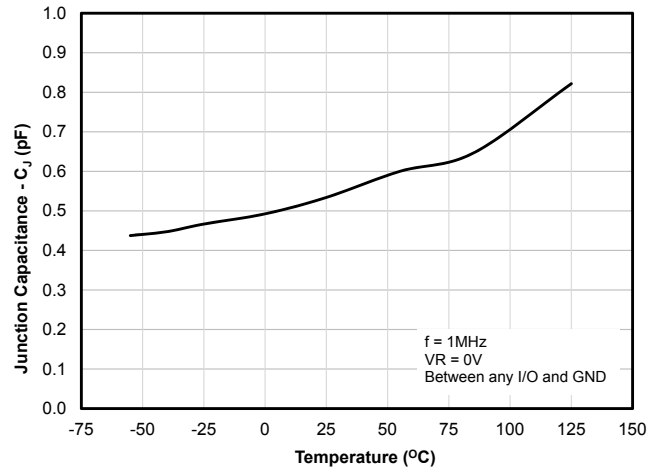

### Insertion Loss - S21

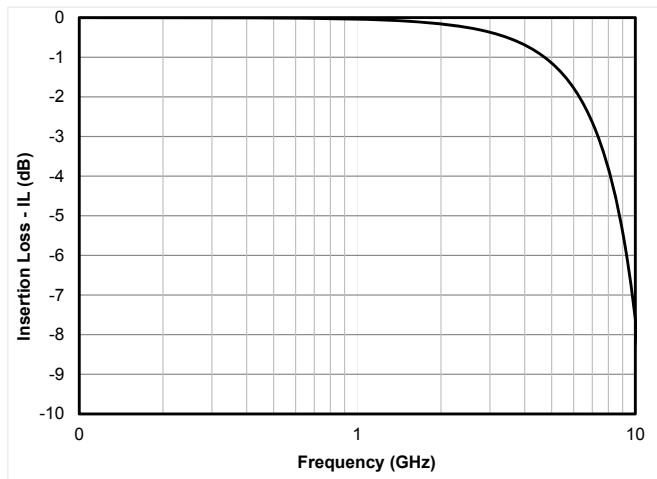

### Analog Crosstalk

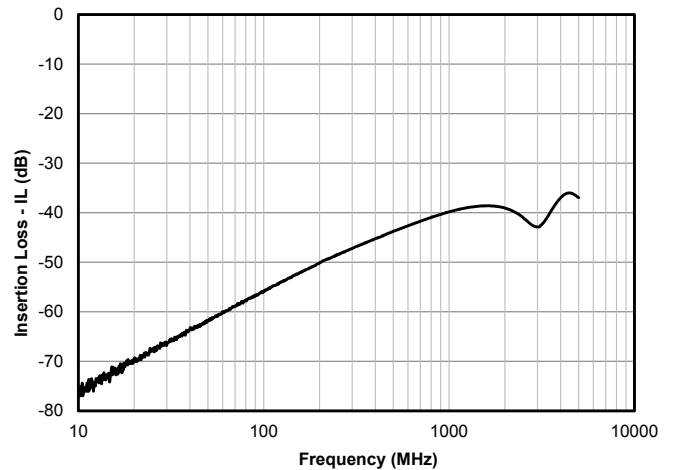

# Application Information

## USB Interface Protection

For USB 3.0 applications, RClamp3324P is recommended for protecting the 5Gb/s SuperSpeed line pairs. Figure 1 below shows an example of protecting a USB 3.0 Type-A interfaces (host side shown). Lines are routed through each device entering at pins 1, 2, 4, and 5 and exiting at pins 10, 9, 7, and 6 respectively (Figure 2). Each trace should run under the device and connect the pins together. Ground connection is made at the center tabs (pins 3, and 8). Traces should be kept the same length to avoid impedance mismatch. The differential impedance of each pair can be controlled for USB 3.0 (85 Ohms +/-15%) while maintaining a minimum trace-to-trace and trace-to-pad spacing. Individual PCB design constraints may necessitate different spacing or trace width. Both ground pads should be connected for optimal performance. Ground connection is made using filled via-in-pad.

RClamp0512TQ is be used to protect D+ and D- lines. These lines are routed through RClamp0512TQ at pin1 and pin 2. Pin 3 is connected to the ground plane. RClamp0512TQ is qualified to AEC-Q100. Additional information may be found on the device data sheet.

Single line devices such as uClamp0571P are recommended for surge and ESD protection of the VBus line. This device features high surge and ESD capability and may be used on 5V power rails. In power delivery (PD) applications, higher working voltage TVS device may be needed. Options exist for ESD and surge protection up to 24V.

## Device Placement

Placement of the protection component is a critical element for effective ESD suppression. TVS diodes should be placed as close to the connector as possible. This helps reduce transient coupling to nearby traces.

Figure 1 - USB 3.0 Type-A Protection Example

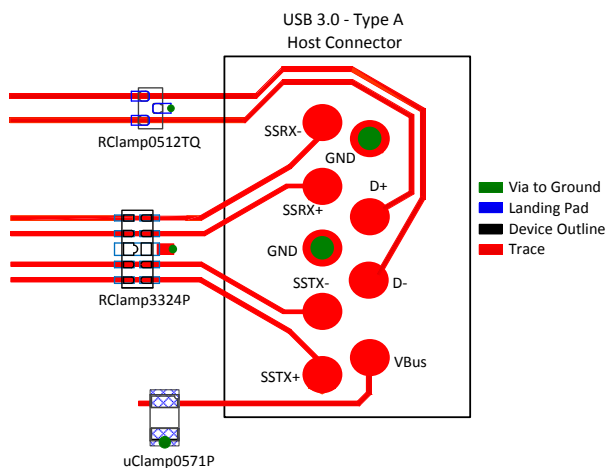
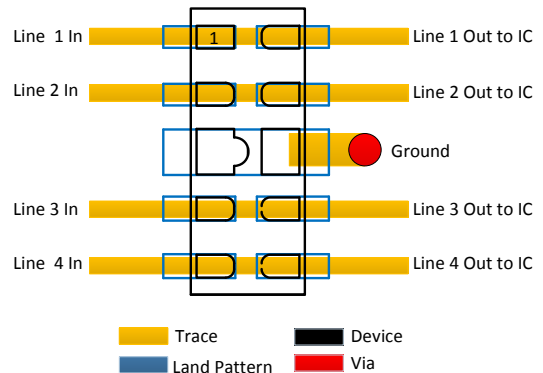
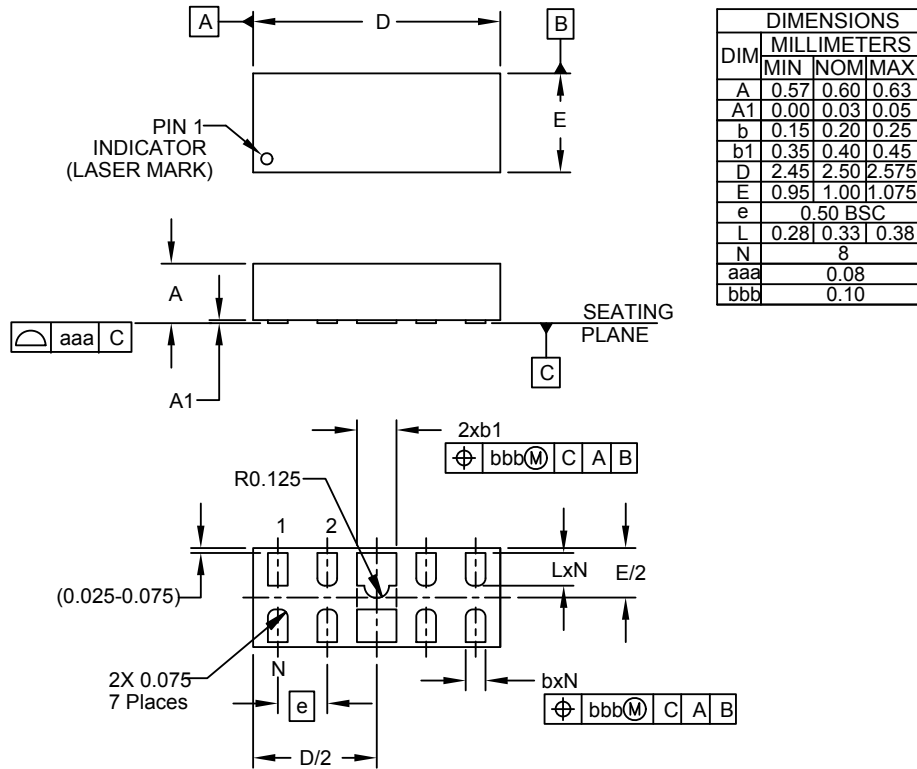

Figure 2 - Trace Routing



## Outline Drawing - SGP2510P8



- NOTES:  
1. CONTROLLING DIMENSIONS ARE IN MILLIMETERS (ANGLES IN DEGREES).

## Land Pattern - SGP2510P8

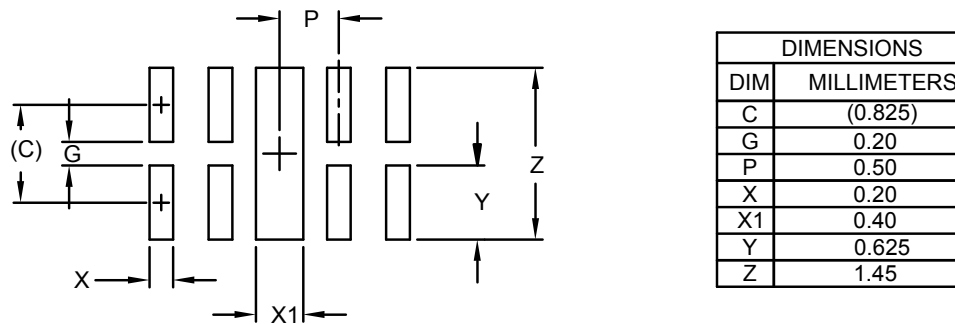

- NOTES:  
1. CONTROLLING DIMENSIONS ARE IN MILLIMETERS (ANGLES IN DEGREES).  
2. THIS LAND PATTERN IS FOR REFERENCE PURPOSES ONLY.  
CONSULT YOUR MANUFACTURING GROUP TO ENSURE YOUR COMPANY'S MANUFACTURING GUIDELINES ARE MET.

# Marking Code

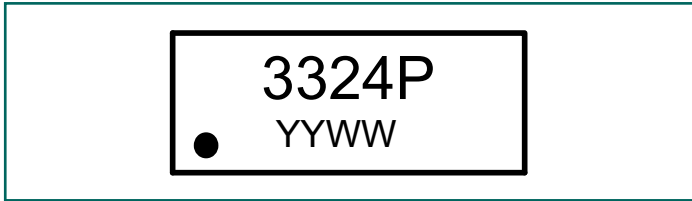

Notes: Dot indicates pin 1 location

# Tape and Reel Specification

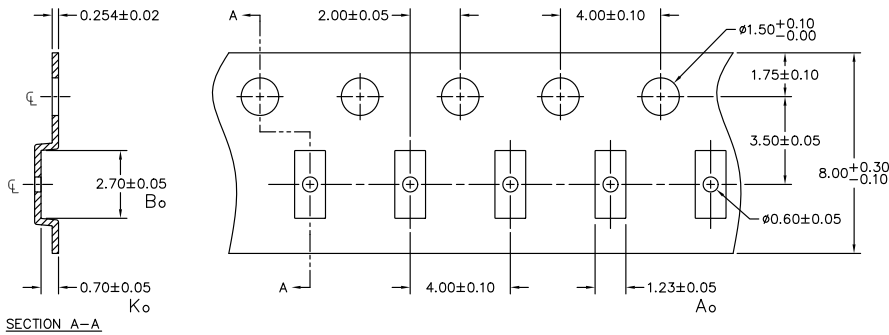

NOTES: 1.) ALL DIMENSIONS IN MILLIMETERS UNLESS OTHERWISE SPECIFIED.

Carrier Tape, 4mm Pitch Option

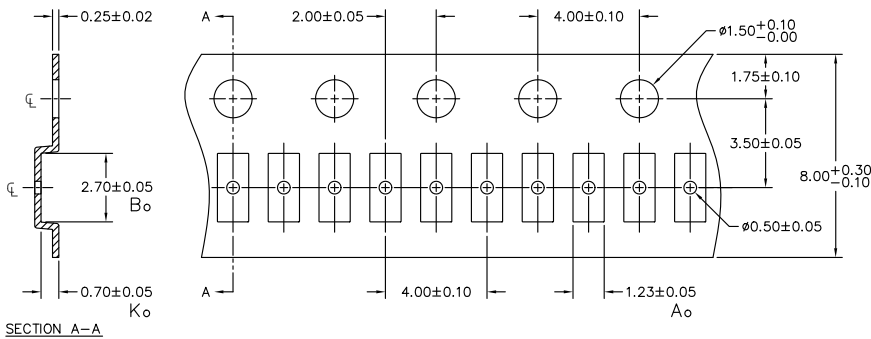

NOTES: 1.) ALL DIMENSIONS IN MILLIMETERS UNLESS OTHERWISE SPECIFIED.

Carrier Tape, 2mm Pitch Option

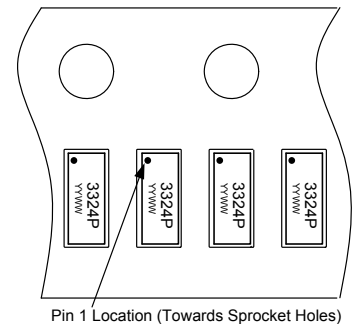

Device Orientation in Tape

# Ordering Information

Part Number	Qty per Reel	Pocket Pitch	Reel Size
RClamp3324P.TCT	3,000	4mm	7"
RClamp3324P.TNT	10,000	2mm	7"
RailClamp and RClamp are registered trademarks of Semtech Corporation			



---

#### IMPORTANT NOTICE

Information relating to this product and the application or design described herein is believed to be reliable, however such information is provided as a guide only and Semtech assumes no liability for any errors in this document, or for the application or design described herein. Semtech reserves the right to make changes to the product or this document at any time without notice. Buyers should obtain the latest relevant information before placing orders and should verify that such information is current and complete. Semtech warrants performance of its products to the specifications applicable at the time of sale, and all sales are made in accordance with Semtech's standard terms and conditions of sale.

SEMTECH PRODUCTS ARE NOT DESIGNED, INTENDED, AUTHORIZED OR WARRANTED TO BE SUITABLE FOR USE IN LIFE-SUPPORT APPLICATIONS, DEVICES OR SYSTEMS, OR IN NUCLEAR APPLICATIONS IN WHICH THE FAILURE COULD BE REASONABLY EXPECTED TO RESULT IN PERSONAL INJURY, LOSS OF LIFE OR SEVERE PROPERTY OR ENVIRONMENTAL DAMAGE. INCLUSION OF SEMTECH PRODUCTS IN SUCH APPLICATIONS IS UNDERSTOOD TO BE UNDERTAKEN SOLELY AT THE CUSTOMER'S OWN RISK. Should a customer purchase or use Semtech products for any such unauthorized application, the customer shall indemnify and hold Semtech and its officers, employees, subsidiaries, affiliates, and distributors harmless against all claims, costs damages and attorney fees which could arise.

The Semtech name and logo are registered trademarks of the Semtech Corporation. All other trademarks and trade names mentioned may be marks and names of Semtech or their respective companies. Semtech reserves the right to make changes to, or discontinue any products described in this document without further notice. Semtech makes no warranty, representation or guarantee, express or implied, regarding the suitability of its products for any particular purpose. All rights reserved.

© Semtech 2015

---

#### Contact Information

Semtech Corporation  
200 Flynn Road, Camarillo, CA 93012  
Phone: (805) 498-2111, Fax: (805) 498-3804  
[www.semtech.com](http://www.semtech.com)