



# FGAF40N60SMD

## 600 V, 40 A Field Stop IGBT

### Features

- Maximum Junction Temperature :  $T_J = 175^\circ\text{C}$
- Positive Temperature Co-efficient for easy Parallel Operating
- High Current Capability
- Low Saturation Voltage:  $V_{CE(sat)} = 1.9 \text{ V(Typ.) @ } I_C = 40 \text{ A}$
- High Input Impedance
- Fast Switching:  $E_{OFF} = 6.5 \text{ } \mu\text{J/A}$
- Tightened Parameter Distribution
- RoHS Compliant

### General Description

Using novel field stop IGBT technology, Fairchild®'s new series of field stop 2<sup>nd</sup> generation IGBTs offer the optimum performance for solar inverter, UPS, welder and PFC applications where low conduction and switching losses are essential.

### Applications

- Sewing Machine, CNC
- Home Appliances, Motor-Control

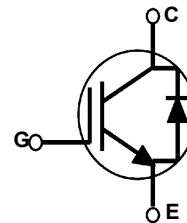
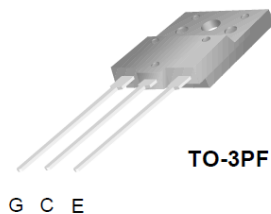

### Absolute Maximum Ratings

Symbol	Description	Ratings	Unit
$V_{CES}$	Collector to Emitter Voltage	600	V
$V_{GES}$	Gate to Emitter Voltage	$\pm 20$	V
$I_C$	Collector Current @ $T_C = 25^\circ\text{C}$	80*	A
	Collector Current @ $T_C = 100^\circ\text{C}$	40*	A
$I_{CM(1)}$	Pulsed Collector Current	120*	A
$I_F$	Diode Forward Current @ $T_C = 25^\circ\text{C}$	40*	A
	Diode Forward Current @ $T_C = 100^\circ\text{C}$	20*	A
$I_{FM(1)}$	Pulsed Diode Maximum Forward Current	120*	A
$P_D$	Maximum Power Dissipation @ $T_C = 25^\circ\text{C}$	79	W
	Maximum Power Dissipation @ $T_C = 100^\circ\text{C}$	39	W
$T_J$	Operating Junction Temperature	-55 to +175	$^\circ\text{C}$
$T_{stg}$	Storage Temperature Range	-55 to +175	$^\circ\text{C}$
$T_L$	Maximum Lead Temp. for soldering Purposes, 1/8" from case for 5 seconds	300	$^\circ\text{C}$

**Notes:**

\*Drain current limited by maximum junction temperature

1: Repetitive rating: Pulse width limited by max. junction temperature

## Thermal Characteristics

Symbol	Parameter	Typ.	Max.	Unit
$R_{\theta JC}$ (IGBT)	Thermal Resistance, Junction to Case	-	1.57	$^{\circ}\text{C}/\text{W}$
$R_{\theta JC}$ (Diode)	Thermal Resistance, Junction to Case	-	3.27	$^{\circ}\text{C}/\text{W}$
$R_{\theta JA}$	Thermal Resistance, Junction to Ambient	-	40	$^{\circ}\text{C}/\text{W}$

## Package Marking and Ordering Information

Device Marking	Device	Package	Reel Size	Tape Width	Quantity
FGAF40N60SMD	FGAF40N60SMD	TO-3PF	-	-	30

## Electrical Characteristics of the IGBT $T_C = 25^{\circ}\text{C}$ unless otherwise noted

Symbol	Parameter	Test Conditions	Min.	Typ.	Max.	Unit
<b>Off Characteristics</b>						
$BV_{CES}$	Collector to Emitter Breakdown Voltage	$V_{GE} = 0\text{V}, I_C = 250\mu\text{A}$	600	-	-	V
$\frac{\Delta BV_{CES}}{\Delta T_J}$	Temperature Coefficient of Breakdown Voltage	$V_{GE} = 0\text{V}, I_C = 250\mu\text{A}$	-	0.6	-	$\text{V}/^{\circ}\text{C}$
$I_{CES}$	Collector Cut-Off Current	$V_{CE} = V_{CES}, V_{GE} = 0\text{V}$	-	-	250	$\mu\text{A}$
$I_{GES}$	G-E Leakage Current	$V_{GE} = V_{GES}, V_{CE} = 0\text{V}$	-	-	$\pm 400$	nA
<b>On Characteristics</b>						
$V_{GE(th)}$	G-E Threshold Voltage	$I_C = 250\mu\text{A}, V_{CE} = V_{GE}$	3.5	4.5	6.0	V
$V_{CE(sat)}$	Collector to Emitter Saturation Voltage	$I_C = 40\text{A}, V_{GE} = 15\text{V}$	-	1.9	-	V
		$I_C = 40\text{A}, V_{GE} = 15\text{V}, T_C = 175^{\circ}\text{C}$	-	2.1	-	V
<b>Dynamic Characteristics</b>						
$C_{ies}$	Input Capacitance	$V_{CE} = 30\text{V}, V_{GE} = 0\text{V}, f = 1\text{MHz}$	-	1880	-	pF
$C_{oes}$	Output Capacitance		-	180	-	pF
$C_{res}$	Reverse Transfer Capacitance		-	50	-	pF
<b>Switching Characteristics</b>						
$t_{d(on)}$	Turn-On Delay Time	$V_{CC} = 400\text{V}, I_C = 40\text{A}, R_G = 6\Omega, V_{GE} = 15\text{V}, \text{Inductive Load}, T_C = 25^{\circ}\text{C}$	-	12	-	ns
$t_r$	Rise Time		-	20	-	ns
$t_{d(off)}$	Turn-Off Delay Time		-	92	-	ns
$t_f$	Fall Time		-	13	17	ns
$E_{on}$	Turn-On Switching Loss		-	0.87	-	mJ
$E_{off}$	Turn-Off Switching Loss		-	0.26	0.34	mJ
$E_{ts}$	Total Switching Loss	-	1.13	-	mJ	
$t_{d(on)}$	Turn-On Delay Time	$V_{CC} = 400\text{V}, I_C = 40\text{A}, R_G = 6\Omega, V_{GE} = 15\text{V}, \text{Inductive Load}, T_C = 175^{\circ}\text{C}$	-	15	-	ns
$t_r$	Rise Time		-	22	-	ns
$t_{d(off)}$	Turn-Off Delay Time		-	116	-	ns
$t_f$	Fall Time		-	16	-	ns
$E_{on}$	Turn-On Switching Loss		-	0.97	-	mJ
$E_{off}$	Turn-Off Switching Loss		-	0.60	-	mJ
$E_{ts}$	Total Switching Loss	-	1.57	-	mJ	

**Electrical Characteristics of the IGBT** (Continued)

Symbol	Parameter	Test Conditions	Min.	Typ.	Max	Unit
$Q_g$	Total Gate Charge	$V_{CE} = 400V, I_C = 40A,$ $V_{GE} = 15V$	-	119	-	nC
$Q_{ge}$	Gate to Emitter Charge		-	13	-	nC
$Q_{gc}$	Gate to Collector Charge		-	58	-	nC

**Electrical Characteristics of the Diode**  $T_C = 25^\circ C$  unless otherwise noted

Symbol	Parameter	Test Conditions	Min.	Typ.	Max	Unit	
$V_{FM}$	Diode Forward Voltage	$I_F = 20A$	$T_C = 25^\circ C$	-	2.3	-	V
			$T_C = 175^\circ C$	-	1.67	-	
$E_{rec}$	Reverse Recovery Energy	$I_F = 20A, dI_F/dt = 200A/\mu s$	$T_C = 175^\circ C$	-	48.9	-	$\mu J$
$t_{rr}$	Diode Reverse Recovery Time		$T_C = 25^\circ C$	-	36	-	ns
			$T_C = 175^\circ C$	-	110	-	
$Q_{rr}$	Diode Reverse Recovery Charge		$T_C = 25^\circ C$	-	46.8	-	nC
		$T_C = 175^\circ C$	-	445	-		

## Typical Performance Characteristics

Figure 1. Typical Output Characteristics

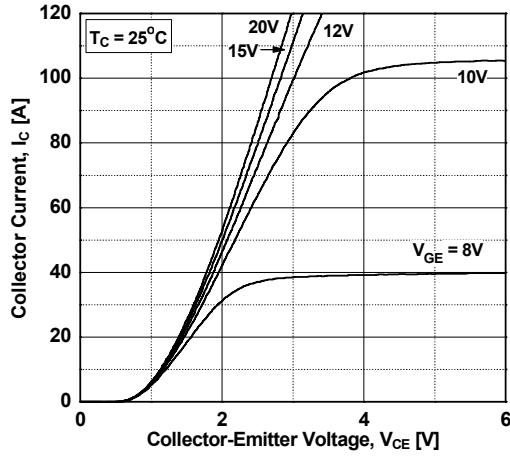

Figure 2. Typical Output Characteristics

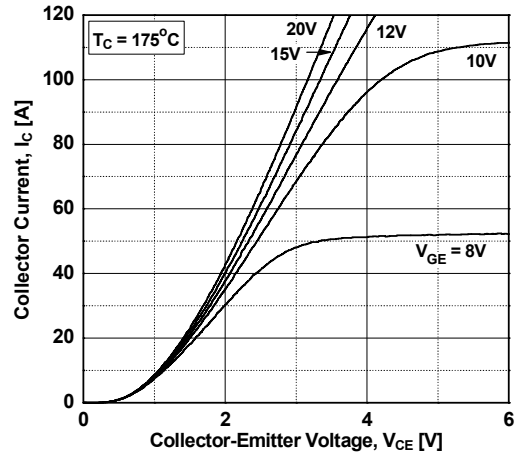

Figure 3. Typical Saturation Voltage Characteristics

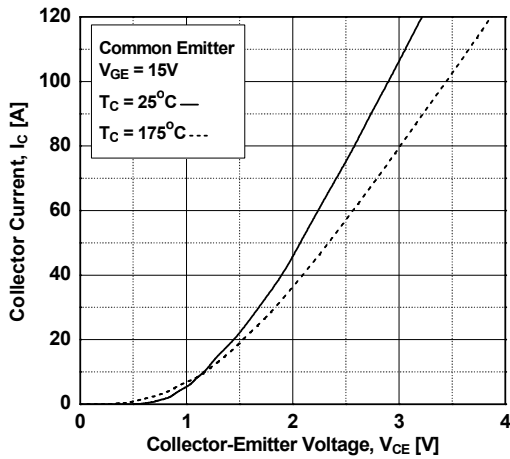

Figure 4. Transfer Characteristics

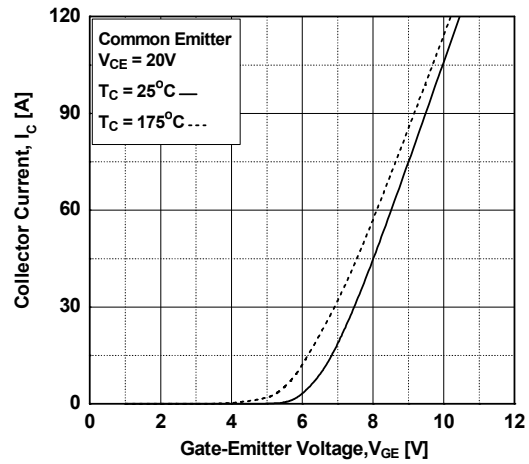

Figure 5. Saturation Voltage vs. Case Temperature at Variant Current Level

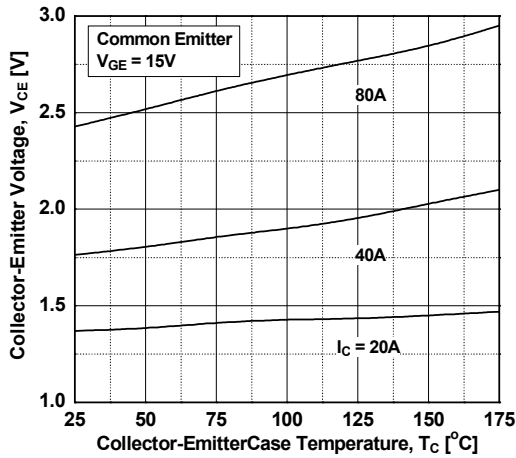
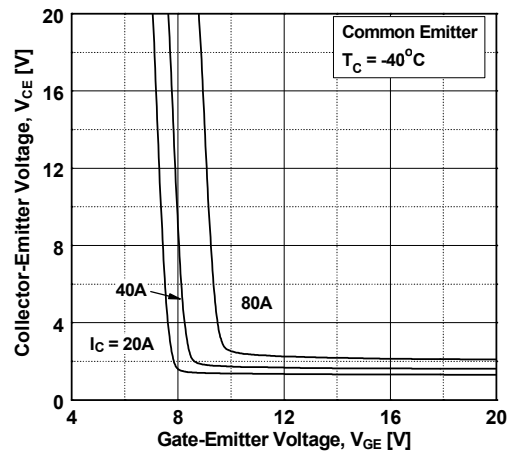

Figure 6. Saturation Voltage vs. Vge



## Typical Performance Characteristics

Figure 7. Saturation Voltage vs.  $V_{GE}$

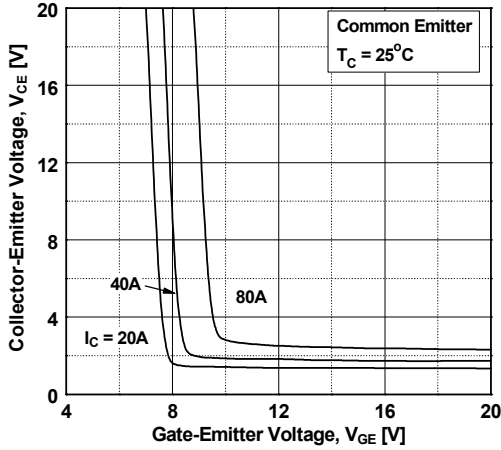

Figure 8. Saturation Voltage vs.  $V_{GE}$

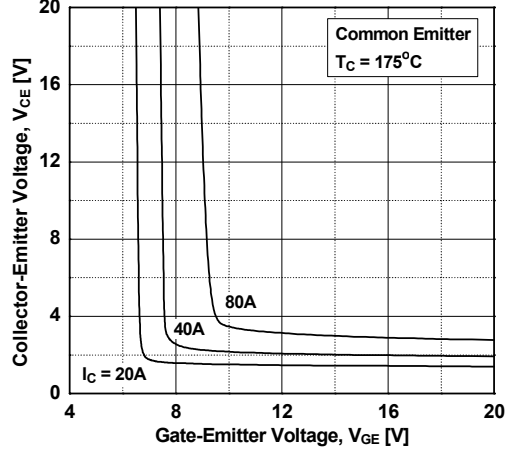

Figure 9. Capacitance Characteristics

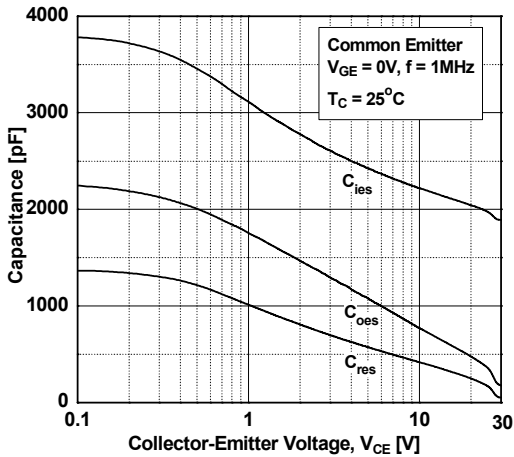

Figure 10. Gate charge Characteristics

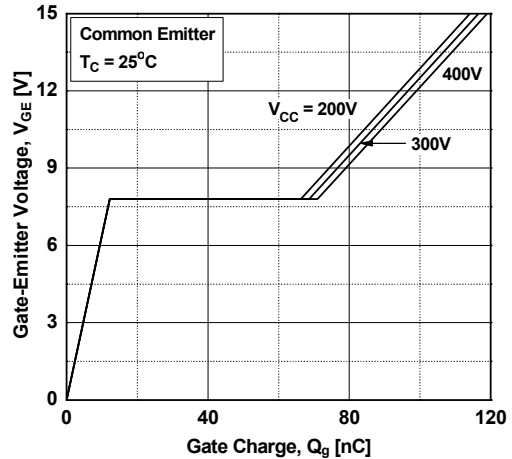

Figure 11. SOA Characteristics

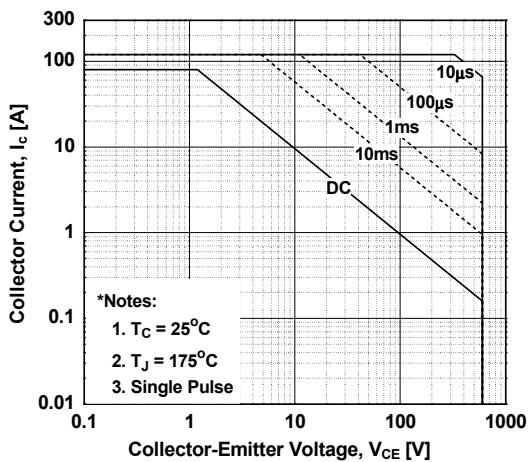
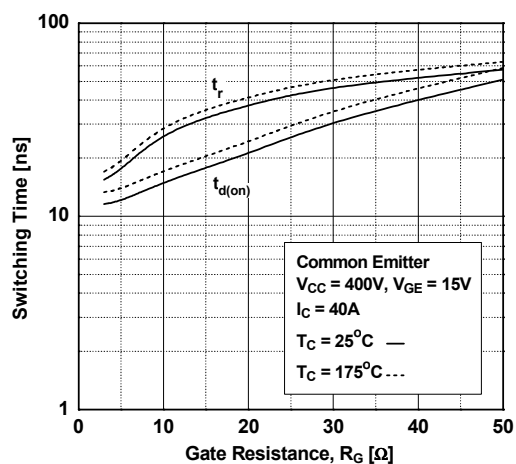
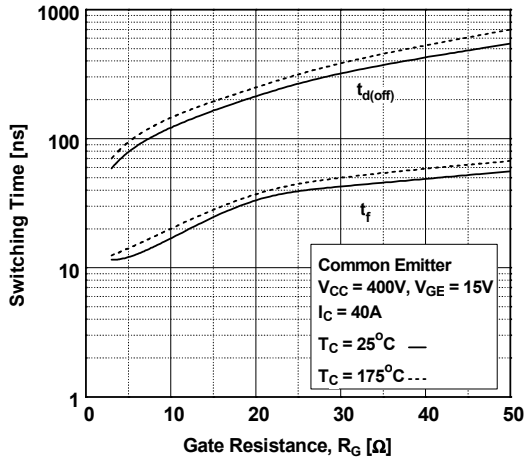

Figure 12. Turn-on Characteristics vs. Gate Resistance



## Typical Performance Characteristics

**Figure 13. Turn-off Characteristics vs. Gate Resistance**



**Figure 14. Turn-on Characteristics vs. Collector Current**

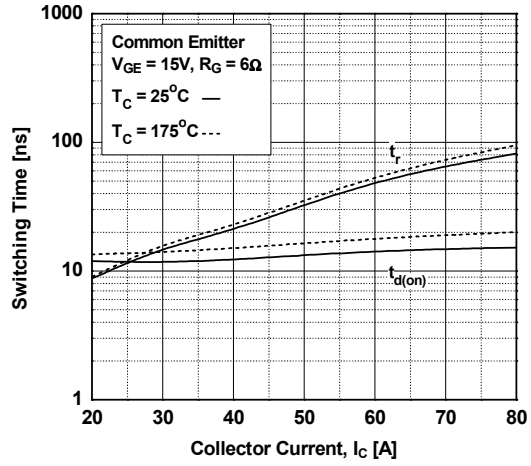

**Figure 15. Turn-off Characteristics vs. Collector Current**

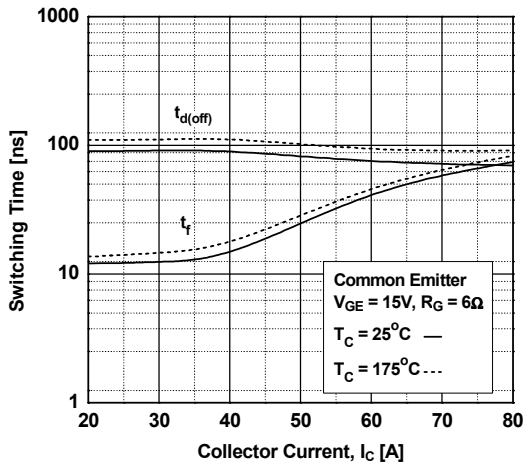

**Figure 16. Switching Loss vs. Gate Resistance**

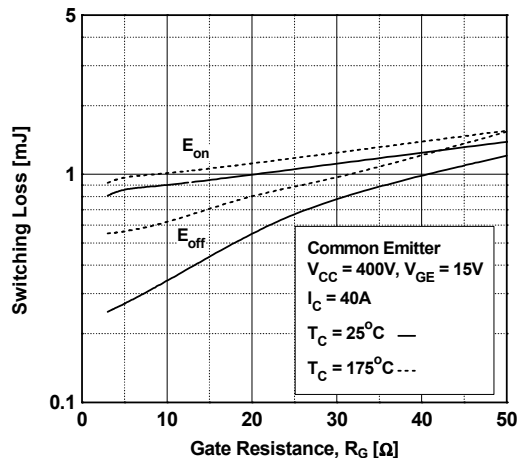

**Figure 17. Switching Loss vs. Collector Current**

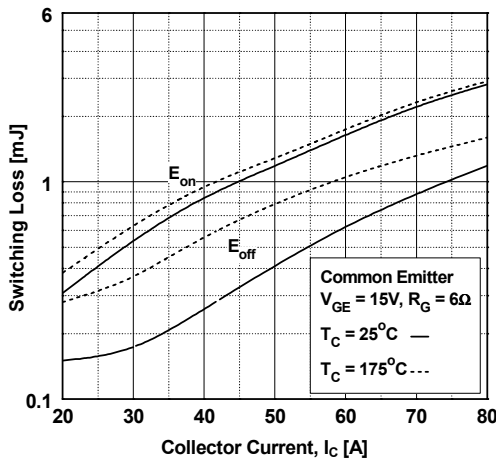

**Figure 18. Turn off Switching SOA Characteristics**

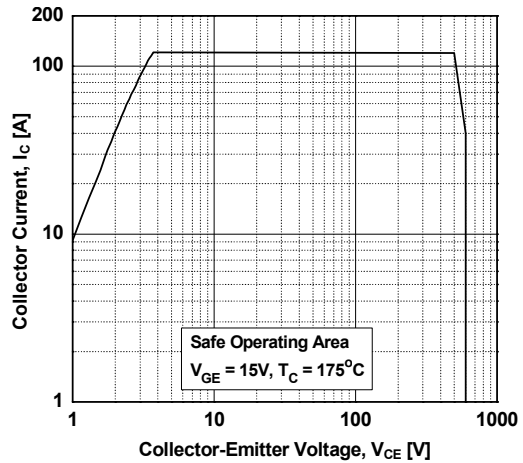

Typical Performance Characteristics

Figure 19. Current Derating

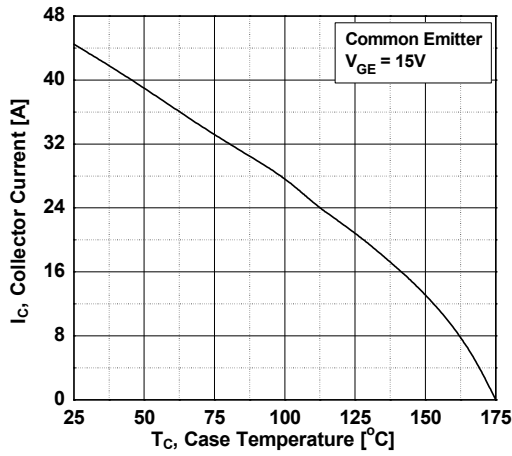

Figure 20. Power Dissipation

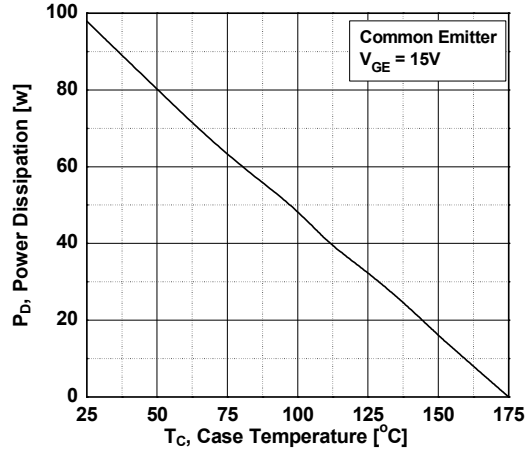

Figure 21. Load Current Vs. Frequency

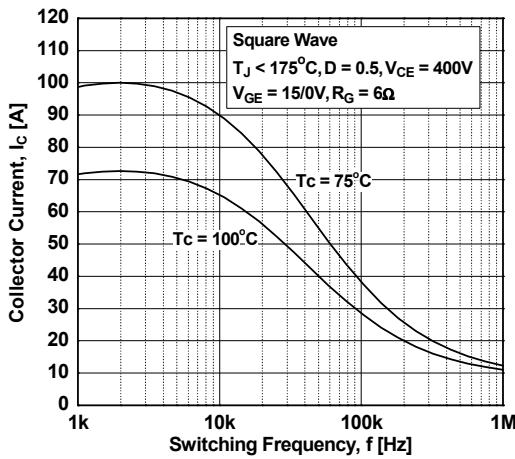

Figure 22. Forward Characteristics

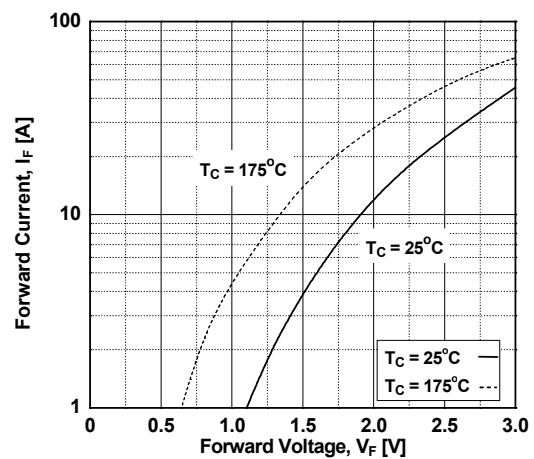

Figure 23. Reverse Current

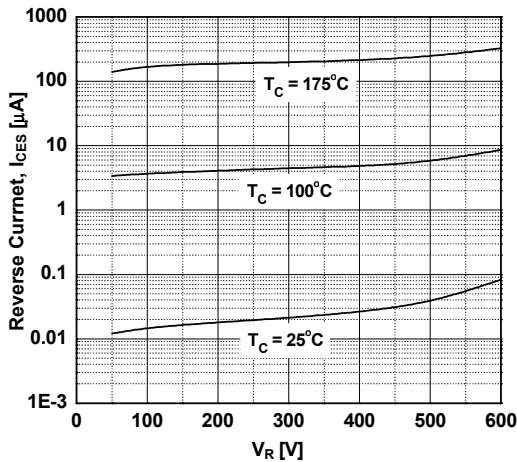
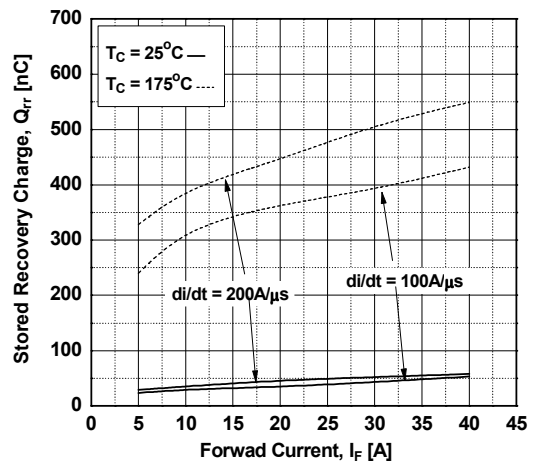

Figure 24. Stored Charge



Typical Performance Characteristics

Figure 25. Reverse Recovery Time

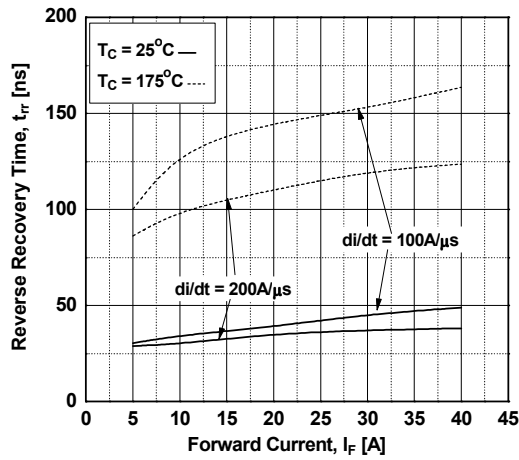

Figure 26. Transient Thermal Impedance of IGBT

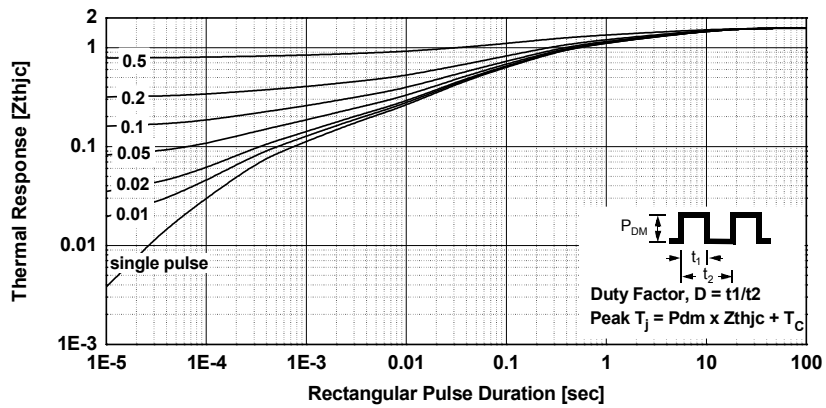
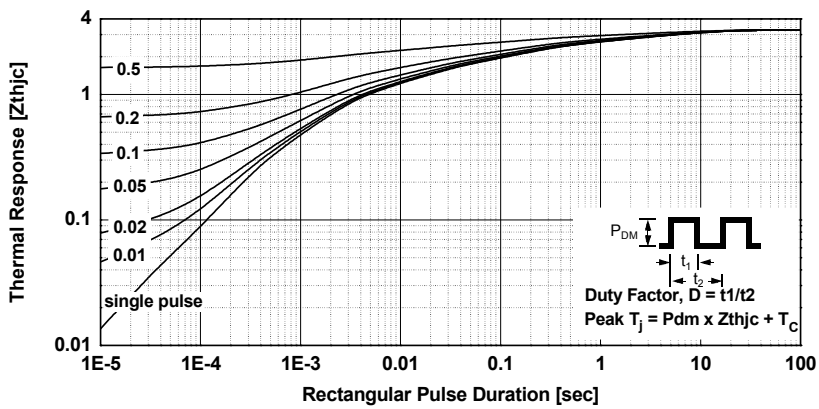

Figure 27. Transient Thermal Impedance of Diode





Mechanical Dimensions

TO-3PF

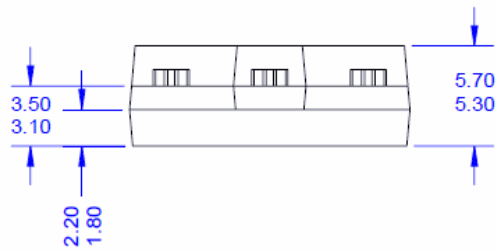
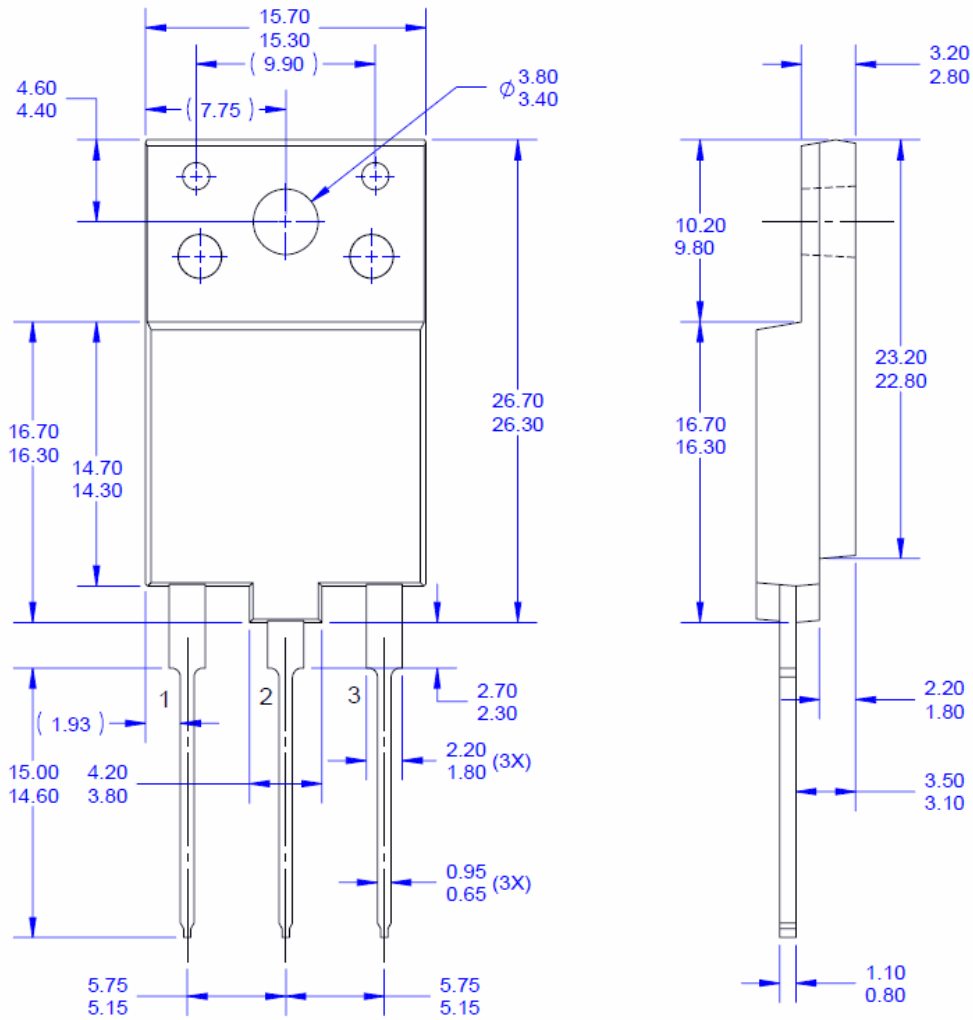

NOTES:





- A. THIS PACKAGE CONFORMS TO SC94 JEITA PACKAGING STANDARD.
- B. ALL DIMENSIONS ARE IN MILLIMETERS.
- C. DIMENSIONS ARE EXCLUSIVE OF BURRS, MOLD FLASH AND TIE BAR PROTRUSIONS.
- D. PIN 2 CONNECTS TO DAP.
- E. DRAWING FILE NAME: TO3PFA03REV1

Dimensions in Millimeters

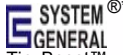

**TRADEMARKS**

The following includes registered and unregistered trademarks and service marks, owned by Fairchild Semiconductor and/or its global subsidiaries, and is not intended to be an exhaustive list of all such trademarks.

- |                                                                                              |                                                                                                                         |                                                                                                      |
|----------------------------------------------------------------------------------------------|-------------------------------------------------------------------------------------------------------------------------|------------------------------------------------------------------------------------------------------|
| 2Cool™                                                                                       | FPS™                                                                                                                    | Sync-Lock™                                                                                           |
| AccuPower™                                                                                   | F-PFS™                                                                                                                  |  SYSTEM GENERAL™* |
| AX-CAP®*                                                                                     | FRFET®                                                                                                                  | TinyBoost™                                                                                           |
| BitSiC™                                                                                      | Global Power Resource <sup>SM</sup>                                                                                     | TinyBuck™                                                                                            |
| Build it Now™                                                                                | Green Bridge™                                                                                                           | TinyCalc™                                                                                            |
| CorePLUS™                                                                                    | Green FPS™                                                                                                              | TinyLogic®                                                                                           |
| CorePOWER™                                                                                   | Green FPS™ e-Series™                                                                                                    | TINYOPTO™                                                                                            |
| CROSSVOLT™                                                                                   | Gmax™                                                                                                                   | TinyPower™                                                                                           |
| CTL™                                                                                         | GTO™                                                                                                                    | TinyPWM™                                                                                             |
| Current Transfer Logic™                                                                      | IntelliMAX™                                                                                                             | TinyWire™                                                                                            |
| DEUXPEED®                                                                                    | ISOPLANAR™                                                                                                              | TranSiC®                                                                                             |
| Dual Cool™                                                                                   | Marking Small Speakers Sound Louder and Better™                                                                         | TriFault Detect™                                                                                     |
| EcoSPARK®                                                                                    | MegaBuck™                                                                                                               | TRUECURRENT®*                                                                                        |
| EfficientMax™                                                                                | MICROCOUPLER™                                                                                                           | μSerDes™                                                                                             |
| ESBC™                                                                                        | MicroFET™                                                                                                               |  SerDes™          |
|  Fairchild® | MicroPak™                                                                                                               | UHC®                                                                                                 |
| Fairchild Semiconductor®                                                                     | MicroPak2™                                                                                                              | Ultra FRFET™                                                                                         |
| FACT Quiet Series™                                                                           | MillerDrive™                                                                                                            | UniFET™                                                                                              |
| FACT®                                                                                        | MotionMax™                                                                                                              | VCX™                                                                                                 |
| FAST®                                                                                        | mWSaver™                                                                                                                | VisualMax™                                                                                           |
| FastvCore™                                                                                   | OptoHiT™                                                                                                                | VoltagePlus™                                                                                         |
| FETBench™                                                                                    | OPTOLOGIC®                                                                                                              | XS™                                                                                                  |
|                                                                                              | OPTOPLANAR®                                                                                                             |                                                                                                      |
|                                                                                              | PowerTrench®                                                                                                            |                                                                                                      |
|                                                                                              | PowerXS™                                                                                                                |                                                                                                      |
|                                                                                              | Programmable Active Droop™                                                                                              |                                                                                                      |
|                                                                                              | QFET®                                                                                                                   |                                                                                                      |
|                                                                                              | QS™                                                                                                                     |                                                                                                      |
|                                                                                              | Quiet Series™                                                                                                           |                                                                                                      |
|                                                                                              | RapidConfigure™                                                                                                         |                                                                                                      |
|                                                                                              |  Saving our world, 1mW/W/kW at a time™ |                                                                                                      |
|                                                                                              | SignalWise™                                                                                                             |                                                                                                      |
|                                                                                              | SmartMax™                                                                                                               |                                                                                                      |
|                                                                                              | SMART START™                                                                                                            |                                                                                                      |
|                                                                                              | Solutions for Your Success™                                                                                             |                                                                                                      |
|                                                                                              | SPM®                                                                                                                    |                                                                                                      |
|                                                                                              | STEALTH™                                                                                                                |                                                                                                      |
|                                                                                              | SuperFET®                                                                                                               |                                                                                                      |
|                                                                                              | SuperSOT™-3                                                                                                             |                                                                                                      |
|                                                                                              | SuperSOT™-6                                                                                                             |                                                                                                      |
|                                                                                              | SuperSOT™-8                                                                                                             |                                                                                                      |
|                                                                                              | SupreMOS®                                                                                                               |                                                                                                      |
|                                                                                              | SyncFET™                                                                                                                |                                                                                                      |

\*Trademarks of System General Corporation, used under license by Fairchild Semiconductor.

**DISCLAIMER**

FAIRCHILD SEMICONDUCTOR RESERVES THE RIGHT TO MAKE CHANGES WITHOUT FURTHER NOTICE TO ANY PRODUCTS HEREIN TO IMPROVE RELIABILITY, FUNCTION, OR DESIGN. FAIRCHILD DOES NOT ASSUME ANY LIABILITY ARISING OUT OF THE APPLICATION OR USE OF ANY PRODUCT OR CIRCUIT DESCRIBED HEREIN; NEITHER DOES IT CONVEY ANY LICENSE UNDER ITS PATENT RIGHTS, NOR THE RIGHTS OF OTHERS. THESE SPECIFICATIONS DO NOT EXPAND THE TERMS OF FAIRCHILD'S WORLDWIDE TERMS AND CONDITIONS, SPECIFICALLY THE WARRANTY THEREIN, WHICH COVERS THESE PRODUCTS.

**LIFE SUPPORT POLICY**

FAIRCHILD'S PRODUCTS ARE NOT AUTHORIZED FOR USE AS CRITICAL COMPONENTS IN LIFE SUPPORT DEVICES OR SYSTEMS WITHOUT THE EXPRESS WRITTEN APPROVAL OF FAIRCHILD SEMICONDUCTOR CORPORATION.

As used here in:

- Life support devices or systems are devices or systems which, (a) are intended for surgical implant into the body or (b) support or sustain life, and (c) whose failure to perform when properly used in accordance with instructions for use provided in the labeling, can be reasonably expected to result in a significant injury of the user.
- A critical component in any component of a life support, device, or system whose failure to perform can be reasonably expected to cause the failure of the life support device or system, or to affect its safety or effectiveness.

**ANTI-COUNTERFEITING POLICY**

Fairchild Semiconductor Corporation's Anti-Counterfeiting Policy. Fairchild's Anti-Counterfeiting Policy is also stated on our external website, www.Fairchildsemi.com, under Sales Support.

Counterfeiting of semiconductor parts is a growing problem in the industry. All manufactures of semiconductor products are experiencing counterfeiting of their parts. Customers who inadvertently purchase counterfeit parts experience many problems such as loss of brand reputation, substandard performance, failed application, and increased cost of production and manufacturing delays. Fairchild is taking strong measures to protect ourselves and our customers from the proliferation of counterfeit parts. Fairchild strongly encourages customers to purchase Fairchild parts either directly from Fairchild or from Authorized Fairchild Distributors who are listed by country on our web page cited above. Products customers buy either from Fairchild directly or from Authorized Fairchild Distributors are genuine parts, have full traceability, meet Fairchild's quality standards for handling and storage and provide access to Fairchild's full range of up-to-date technical and product information. Fairchild and our Authorized Distributors will stand behind all warranties and will appropriately address and warranty issues that may arise. Fairchild will not provide any warranty coverage or other assistance for parts bought from Unauthorized Sources. Fairchild is committed to combat this global problem and encourage our customers to do their part in stopping this practice by buying direct or from authorized distributors.

**PRODUCT STATUS DEFINITIONS**

**Definition of Terms**

Datasheet Identification	Product Status	Definition
Advance Information	Formative / In Design	Datasheet contains the design specifications for product development. Specifications may change in any manner without notice.
Preliminary	First Production	Datasheet contains preliminary data; supplementary data will be published at a later date. Fairchild Semiconductor reserves the right to make changes at any time without notice to improve design.
No Identification Needed	Full Production	Datasheet contains final specifications. Fairchild Semiconductor reserves the right to make changes at any time without notice to improve the design.
Obsolete	Not In Production	Datasheet contains specifications on a product that is discontinued by Fairchild Semiconductor. The datasheet is for reference information only.

Rev. I64