

Features

- Epitaxial Planar Die Construction
- Complementary NPN Type Available (DCP68)
- Ideally Suited for Automated Assembly Processes
- Ideal for Medium Power Switching or Amplification Applications
- **Totally Lead-Free & Fully RoHS compliant (Note 1)**
- **Halogen and Antimony Free. "Green" Device (Note 2)**
- **Qualified to AEC-Q101 Standards for High Reliability**

Mechanical Data

- Case: SOT223
- Case Material: Molded Plastic, "Green Molding" Compound. UL Flammability Classification Rating 94V-0
- Moisture Sensitivity: Level 1 per J-STD-020
- Terminals: Finish - Matte Tin
- Solderable per MIL-STD -202, Method 208
- Weight: 0.112 grams (approximate)



Top View

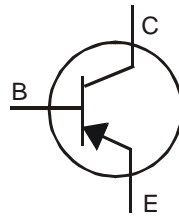

Device Schematic

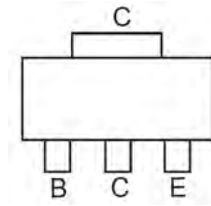

Top View
Pin Out Configuration

Ordering Information (Note 3)

Part Number	Marking	Reel size (inches)	Tape width (mm)	Quantity per reel
DCP69-13	P12	13	12	2500
DCP69-16-13	P12-16	13	12	2500
DCP69-25-13	P12-25	13	12	2500

- Notes:
1. No purposely added lead. Fully EU Directive 2002/95/EC (RoHS) & 2011/65/EU (RoHS 2) compliant.
 2. Halogen and Antimony free "Green" products are defined as those which contain <900ppm bromine, <900ppm chlorine (<1500ppm total Br + Cl) and <1000ppm antimony compounds.
 3. For packaging details, go to our website at <http://www.diodes.com>.

Marking Information

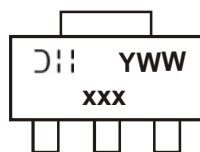

xxx = Product Type Marking Code

P12 = DCP69

P12-16 = DCP69-16

P12-25 = DCP69-25

DII = Manufacturer's code marking

YWW = Date Code Marking

Y = Last digit of year (ex: 1 = 2011)

WW = Week code (01 - 53)

Maximum Ratings @T_A = 25°C unless otherwise specified

Characteristic	Symbol	Value	Units
Collector-Base Voltage	V _{CBO}	-25	V
Collector-Emitter Voltage	V _{CEO}	-20	V
Emitter-Base Voltage	V _{EBO}	-5.0	V
Collector Current	I _C	-1.0	A
Peak Pulse Current	I _{CM}	-2.0	A

Thermal Characteristics @T_A = 25°C unless otherwise specified

Characteristic	Symbol	Value	Unit
Power Dissipation (Note 4)	P _D	1	W
Thermal Resistance, Junction to Ambient Air (Note 4)	R _{θJA}	125	°C/W
Power Dissipation (Note 5)	P _D	2	W
Thermal Resistance, Junction to Ambient Air (Note 5)	R _{θJA}	62.5	°C/W
Operating and Storage Temperature Range	T _J , T _{STG}	-55 to +150	°C

Electrical Characteristics @T_A = 25°C unless otherwise specified

Characteristic	Symbol	Min	Typ	Max	Unit	Test Condition
OFF CHARACTERISTICS						
Collector-Base Breakdown Voltage	BV _{CBO}	-25	—	—	V	I _C = -100μA, I _E = 0
Collector-Emitter Breakdown Voltage (Note 6)	BV _{CEO}	-20	—	—	V	I _C = -10mA, I _B = 0
Emitter-Base Breakdown Voltage	BV _{EBO}	-5.0	—	—	V	I _E = -100μA, I _C = 0
Collector-Base Cutoff Current	I _{CBO}	—	—	-100 -10	nA μA	V _{CB} = -25V, I _E = 0 V _{CB} = -25V, I _E = 0, T _A = 150°C
Emitter-Base Cutoff Current	I _{EBO}	—	—	-100	nA	V _{EB} = -5.0V, I _C = 0
ON CHARACTERISTICS (Note 6)						
DC Current Gain	DCP69, DCP69-16, DCP69-25	50 60	— —	— —	—	V _{CE} = -10V, I _C = -5.0mA V _{CE} = -1.0V, I _C = -1.0A
	DCP69	85	—	375		V _{CE} = -1.0V, I _C = -500mA
	DCP69-16	100	—	250		V _{CE} = -1.0V, I _C = -500mA
	DCP69-25	160	—	375		V _{CE} = -1.0V, I _C = -500mA
Collector-Emitter Saturation Voltage	V _{CE(sat)}	—	—	-0.5	V	I _C = -1.0A, I _B = -100mA
Base-Emitter Turn-On Voltage	V _{BE(on)}	—	—	-0.7 -1.0	V	V _{CE} = -10V, I _C = -5.0mA V _{CE} = -1.0V, I _C = -1.0A
SMALL SIGNAL CHARACTERISTICS						
Current Gain-Bandwidth Product	f _T	40	200	—	MHz	V _{CE} = -5.0V, I _C = -50mA, f = 100MHz
Output Capacitance	C _{obo}	—	17	—	pF	V _{CB} = -10V, f = 1 MHz

Notes: 4. Device mounted on FR-4 PCB; pad layout as shown on in Diodes Inc. suggested pad layout document, which can be found on our website at <http://www.diodes.com>

5. Device mounted on FR-4 PCB with 1in² copper pad layout

6. Measured under pulsed conditions. Pulse width = 300μS. Duty cycle ≤ 2%.

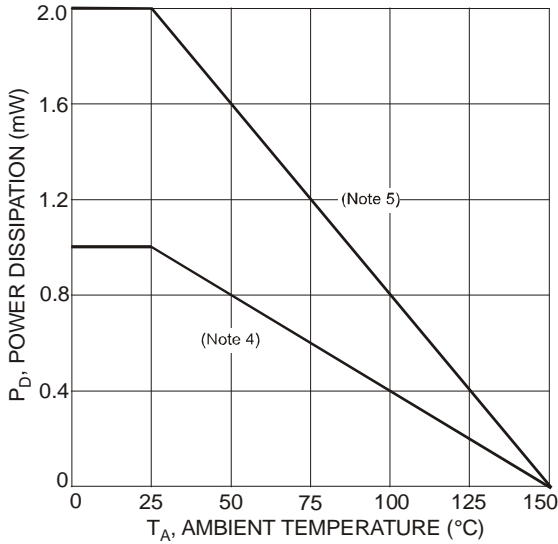

Fig. 1 Power Dissipation vs. Ambient Temperature

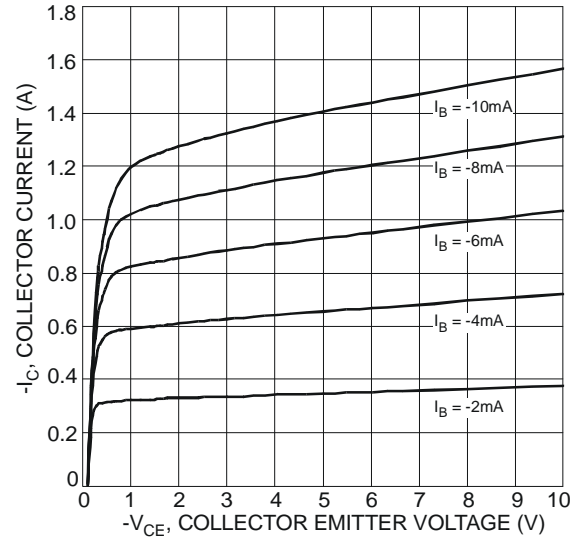

Fig. 2 Typical Collector Current vs. Collector-Emitter Voltage

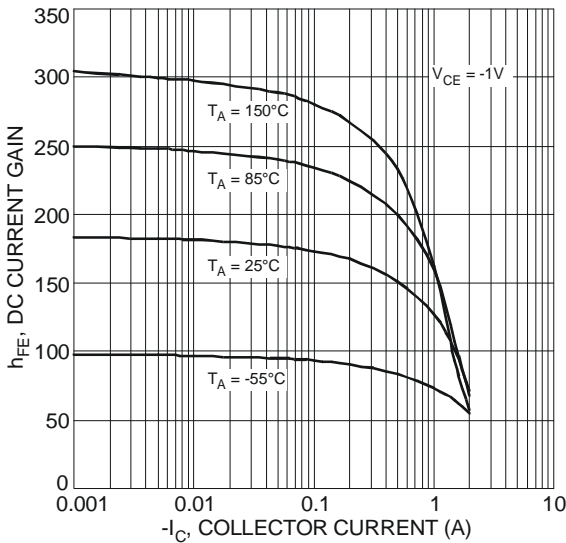

Fig. 3 Typical DC Current Gain vs. Collector Current (DCP69-16)

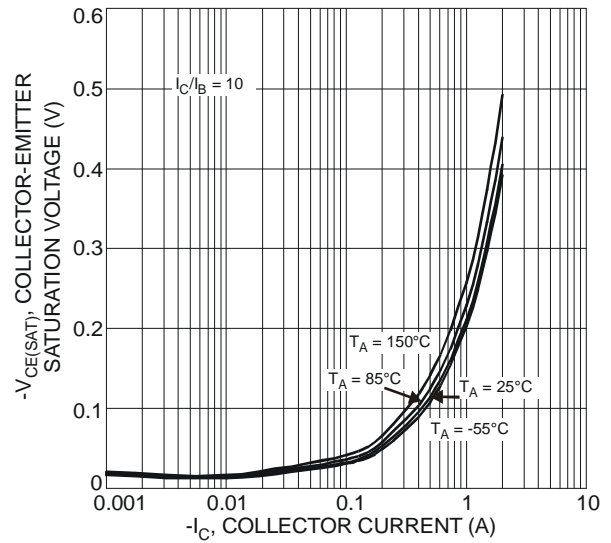

Fig. 4 Typical Collector-Emitter Saturation Voltage vs. Collector Current

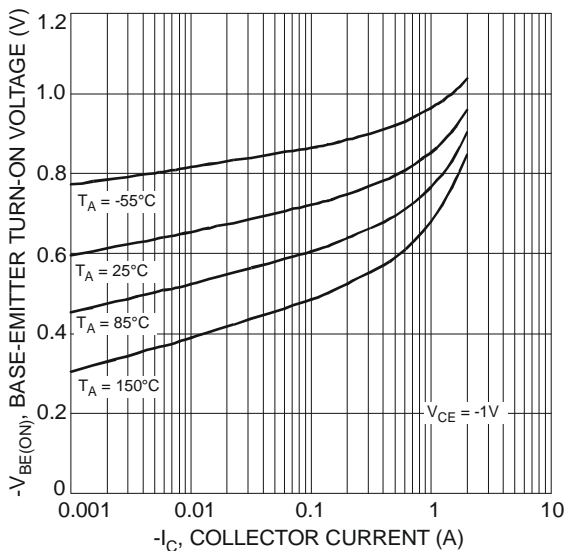

Fig. 5 Typical Base-Emitter Turn-On Voltage vs. Collector Current

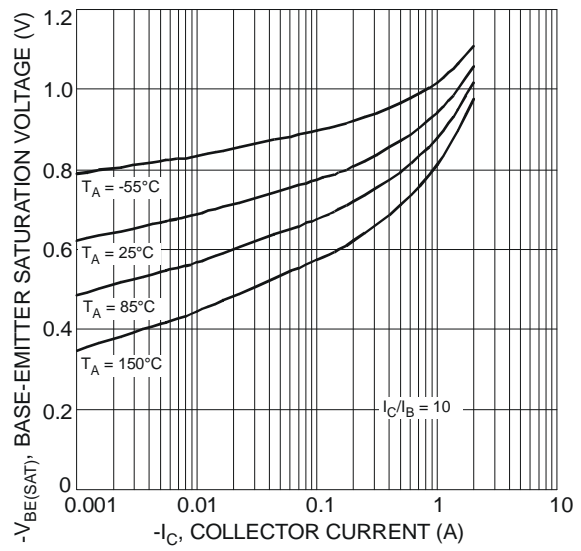

Fig. 6 Typical Base-Emitter Saturation Voltage vs. Collector Current

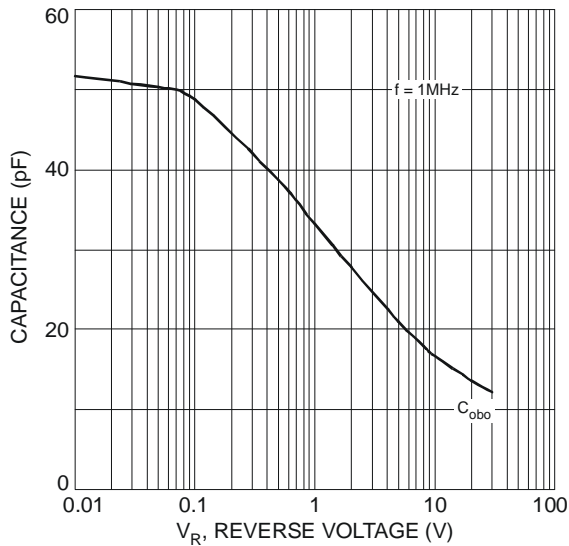

Fig. 7 Typical Output Capacitance Characteristics

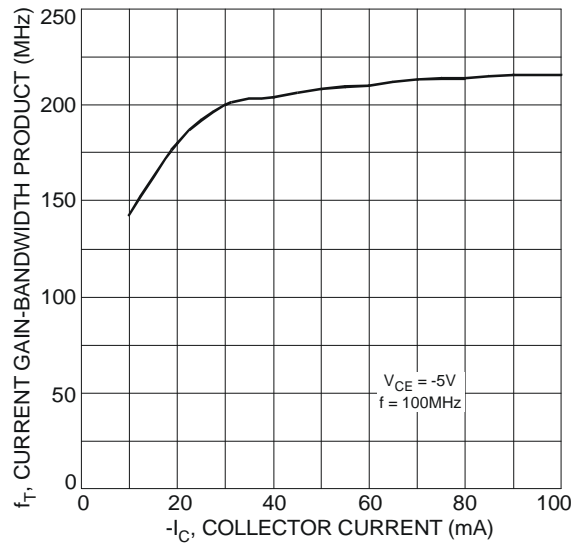
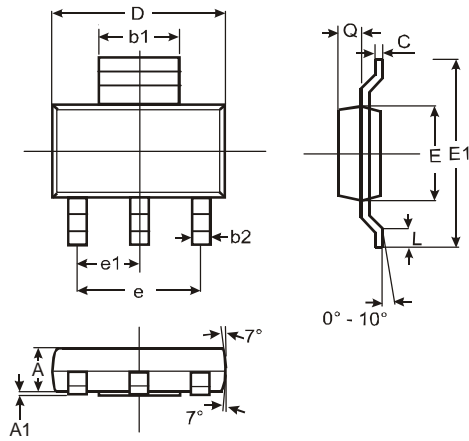

Fig. 8 Typical Gain-Bandwidth Product vs. Collector Current

Package Outline Dimensions



SOT223			
Dim	Min	Max	Typ
A	1.55	1.65	1.60
A1	0.010	0.15	0.05
b1	2.90	3.10	3.00
b2	0.60	0.80	0.70
C	0.20	0.30	0.25
D	6.45	6.55	6.50
E	3.45	3.55	3.50
E1	6.90	7.10	7.00
e	—	—	4.60
e1	—	—	2.30
L	0.85	1.05	0.95
Q	0.84	0.94	0.89
All Dimensions in mm			

Suggested Pad Layout

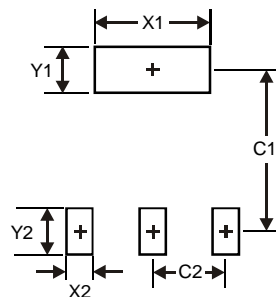

Dimensions	Value (in mm)
X1	3.3
X2	1.2
Y1	1.6
Y2	1.6
C1	6.4
C2	2.3

IMPORTANT NOTICE

DIODES INCORPORATED MAKES NO WARRANTY OF ANY KIND, EXPRESS OR IMPLIED, WITH REGARDS TO THIS DOCUMENT, INCLUDING, BUT NOT LIMITED TO, THE IMPLIED WARRANTIES OF MERCHANTABILITY AND FITNESS FOR A PARTICULAR PURPOSE (AND THEIR EQUIVALENTS UNDER THE LAWS OF ANY JURISDICTION).

Diodes Incorporated and its subsidiaries reserve the right to make modifications, enhancements, improvements, corrections or other changes without further notice to this document and any product described herein. Diodes Incorporated does not assume any liability arising out of the application or use of this document or any product described herein; neither does Diodes Incorporated convey any license under its patent or trademark rights, nor the rights of others. Any Customer or user of this document or products described herein in such applications shall assume all risks of such use and will agree to hold Diodes Incorporated and all the companies whose products are represented on Diodes Incorporated website, harmless against all damages.

Diodes Incorporated does not warrant or accept any liability whatsoever in respect of any products purchased through unauthorized sales channel. Should Customers purchase or use Diodes Incorporated products for any unintended or unauthorized application, Customers shall indemnify and hold Diodes Incorporated and its representatives harmless against all claims, damages, expenses, and attorney fees arising out of, directly or indirectly, any claim of personal injury or death associated with such unintended or unauthorized application.

Products described herein may be covered by one or more United States, international or foreign patents pending. Product names and markings noted herein may also be covered by one or more United States, international or foreign trademarks.

LIFE SUPPORT

Diodes Incorporated products are specifically not authorized for use as critical components in life support devices or systems without the express written approval of the Chief Executive Officer of Diodes Incorporated. As used herein:

A. Life support devices or systems are devices or systems which:

1. are intended to implant into the body, or
2. support or sustain life and whose failure to perform when properly used in accordance with instructions for use provided in the labeling can be reasonably expected to result in significant injury to the user.

B. A critical component is any component in a life support device or system whose failure to perform can be reasonably expected to cause the failure of the life support device or to affect its safety or effectiveness.

Customers represent that they have all necessary expertise in the safety and regulatory ramifications of their life support devices or systems, and acknowledge and agree that they are solely responsible for all legal, regulatory and safety-related requirements concerning their products and any use of Diodes Incorporated products in such safety-critical, life support devices or systems, notwithstanding any devices- or systems-related information or support that may be provided by Diodes Incorporated. Further, Customers must fully indemnify Diodes Incorporated and its representatives against any damages arising out of the use of Diodes Incorporated products in such safety-critical, life support devices or systems.

Copyright © 2012, Diodes Incorporated

www.diodes.com