

VI TELEFILTER

Filter specification

TFS 1227

1/5

Measurement condition

Ambient temperature:	23	°C
Input power level:	0	dBm
Terminating impedance:		
Input:	50	Ω
Output:	50	Ω

Characteristics

Remark:

The maximum attenuation in the pass band is defined as the insertion loss a_e . The nominal frequency f_N is fixed at 1227,6 MHz without any tolerance or limit. The values of absolute attenuation a_{abs} are guaranteed for the whole operating temperature range. The frequency shift of the filter in the operating temperature range is included in the production tolerance scheme.

D a t a		typ. value		tolerance / limit	
Insertion Loss		a_e	2,6 dB	4,5 dB	
Nominal Frequency		f_N	-	1227,6 MHz	
Passband		PB	-	$f_N \pm$	10 MHz
Passband ripple			1,2 dB	max.	2,5 dB
Absolute Attenuation		a_{abs}			
1 MHz ...	1177 MHz		48 dB	min.	40 dB
1197 MHz			30 dB	min.	25 dB
1257 MHz			33 dB	min.	25 dB
1277 MHz ...	2000 MHz		43 dB	min.	40 dB
Group delay ripple within PB			16 ns	max.	25 ns
Phase linearity within PB			16 °p-p	max.	20 °p-p
Input Power Level			-	max.	17 dBm
Operating Temperature Range		OTR	-	- 40 °C ... + 85 °C	
Storage Temperature Range			-	- 45 °C ... + 90 °C	
Temperature Coefficient of Frequency		TC_f *	-44 ppm/K	-	

*) $\Delta f(\text{Hz}) = TC_f(\text{ppm/K}) \times (T - T_0) \times f_{T0}(\text{MHz})$.

Generated:

Checked / Approved:

Tele Filter GmbH
 Potsdamer Straße 18
 D 14 513 TELTOW / Germany
 Tel: (+49) 3328 4784-0 / Fax: (+49) 3328 4784-30
 E-Mail: tft@telefilter.com

VI TELEFILTER reserves the right to make changes to the product(s) and/or information contained herein without notice. No liability is assumed as a result of their use or application. No rights under any patent accompany the sale of any such product(s) or information.

Filter characteristic

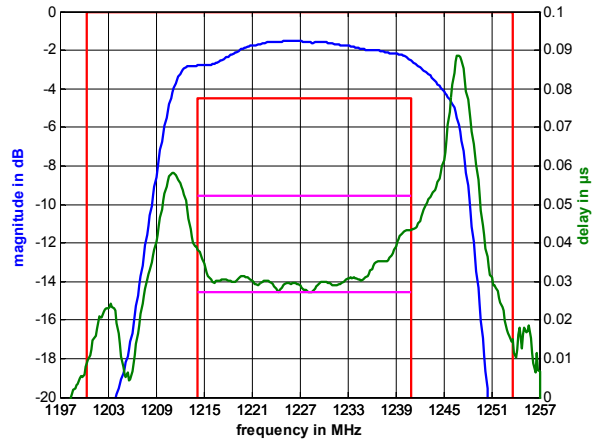
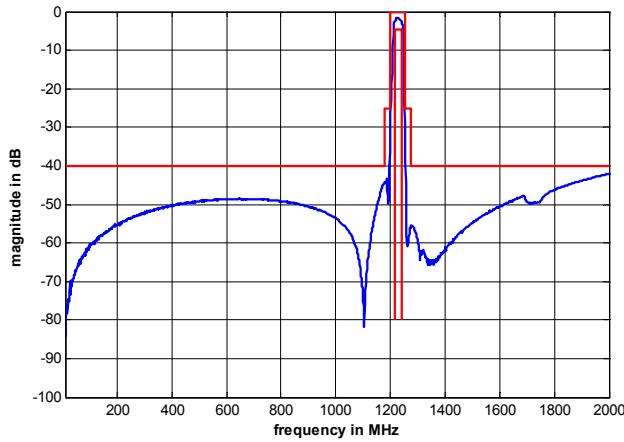

Construction and pin connection

(All dimensions in mm)

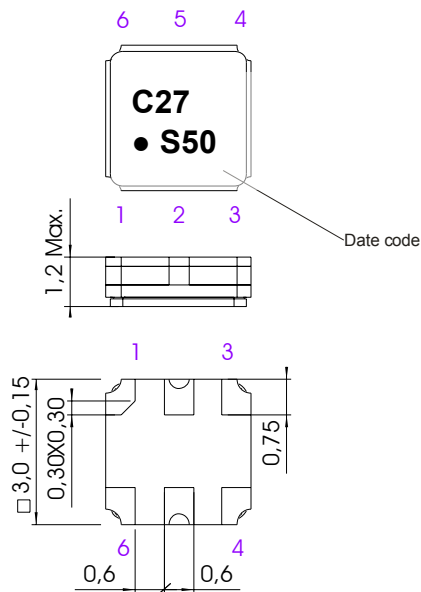

- 1 Ground
- 2 Input
- 3 Ground
- 4 Ground
- 5 Output
- 6 Ground

Date code: Year + week
 S 2004
 T 2005
 U 2006
 ...

50 Ω Test circuit

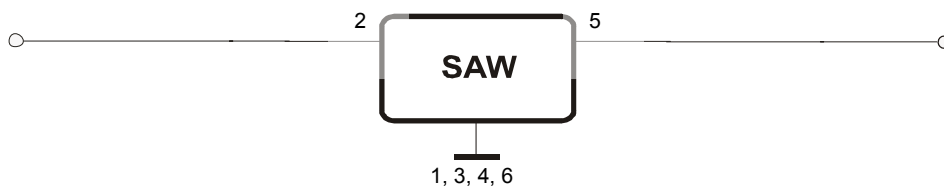

Tele Filter GmbH
 Potsdamer Straße 18
 D 14 513 TELTOW / Germany
 Tel: (+49) 3328 4784-0 / Fax: (+49) 3328 4784-30
 E-Mail: tft@telefilter.com

Stability characteristics

After the following tests the filter shall meet the whole specification:

1. Shock: 500g, 18 ms, half sine wave, 3 shocks each plane;
DIN IEC 68 T2 - 27
2. Vibration: 10 Hz to 500 Hz, 0,35 mm or 5 g respectively, 1 octave per min, 10 cycles per plan, 3 plans;
DIN IEC 68 T2 - 6
3. Change of temperature: -55 °C to 125°C / 30 min. each / 10 cycles
DIN IEC 68 part 2 – 14 Test N
4. Resistance to solder heat (reflow): reflow possible: twice max.;
for temperature conditions refer to the attached "Air reflow temperature conditions" on page 4;

Packing

Tape & Reel: IEC 286 – 3, with exception of value for N and minimum bending radius;
tape type II, embossed carrier tape with top cover tape on the upper side;

max. pieces of filters peer reel:	9000
reel of empty components at start:	min. 300 mm
reel of empty components at start including leader:	min. 500 mm
trailer:	min. 300 mm

Tape (all dimensions in mm)

- W : 8,00 ± 0,3
- Po : 4,00 ± 0,1
- Do : 1,50 +0,1/-0
- E : 1,75 ± 0,1
- F : 3,50 ± 0,05
- G(min) : 0,75
- P2 : 2,00 ± 0,05
- P1 : 4,00 ± 0,1
- D1(min) : 1,50
- Ao : 3,25 ± 0,1
- Bo : 3,25 ± 0,1
- Ct : 5,5 ± 0,1

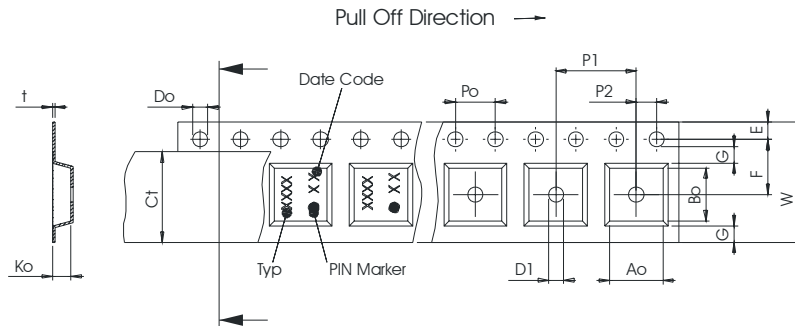

Reel (all dimensions in mm)

- A : 330
- W1 : 8,4 +1,5/-0
- W2(max) : 14,4
- N(min) : 50
- C : 13,0 +0,5/-0,2

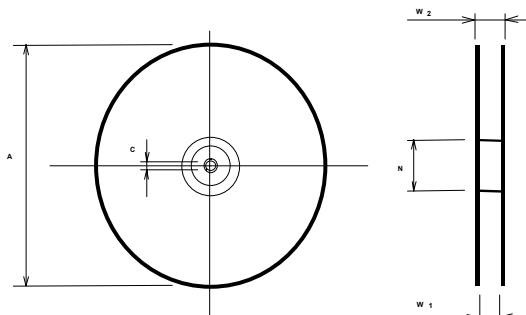

The minimum bending radius is 45 mm.

Tele Filter GmbH
Potsdamer Straße 18
D 14 513 TELTOW / Germany
Tel: (+49) 3328 4784-0 / Fax: (+49) 3328 4784-30
E-Mail: tft@telefilter.com

VI TELEFILTER reserves the right to make changes to the product(s) and/or information contained herein without notice. No liability is assumed as a result of their use or application. No rights under any patent accompany the sale of any such product(s) or information.

Air reflow temperature conditions

Conditions	Exposure
Average ramp-up rate (30°C to 217°C)	less than 3°C/second
> 100°C	between 300 and 600 seconds
> 150°C	between 240 and 500 seconds
> 217°C	between 30 and 150 seconds
Peak temperature	max. 260°C
Time within 5°C of actual peak temperature	between 10 and 30 seconds
Cool-down rate (Peak to 50°C)	less than 6°C/second
Time from 30°C to Peak temperature	no greater than 300 seconds

Chip-mount air reflow profile

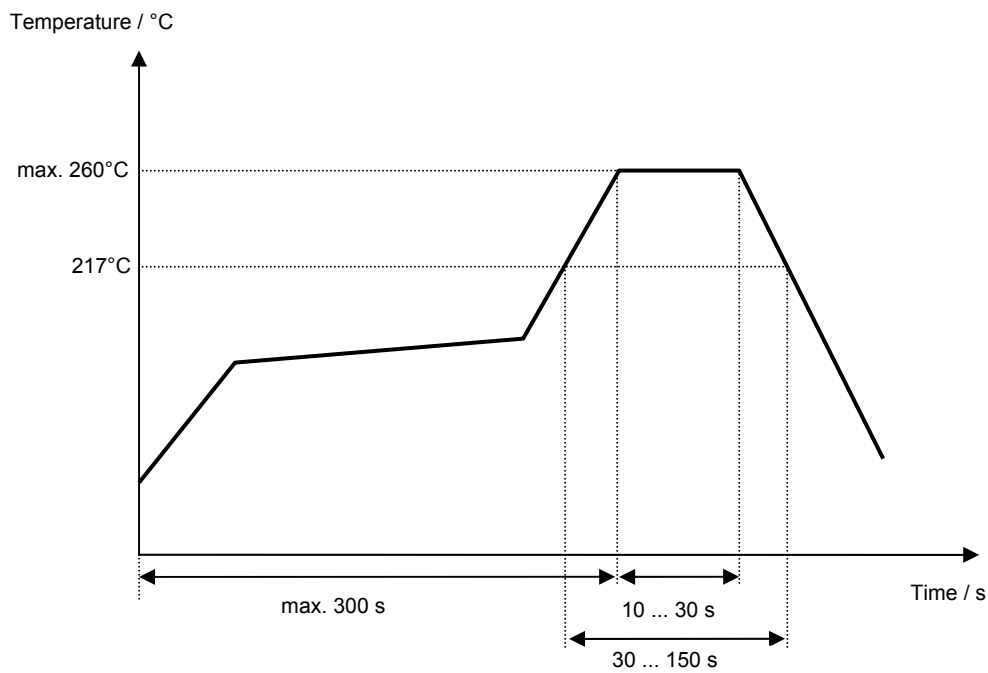

History

Version	Reason of Changes	Name	Date
1.0	- Generation of filter specification.	Martens	25.10.2004
1.1	- Added filter characteristic, changed typical values	Martens	13.12.2004
1.2	- added detailed information about the phase linearity (p-p)	S.Springfeldt	06.07.2009