

FDPF33N25T

N-Channel UniFET™ MOSFET

250 V, 33 A, 94 mΩ



FDPF33N25T N-Channel UniFET™ MOSFET

Features

- $R_{DS(on)} = 94 \text{ m}\Omega$ (Max.) @ $V_{GS} = 10 \text{ V}$, $I_D = 16.5 \text{ A}$
- Low Gate Charge (Typ. 36.8 nC)
- Low Crss (Typ. 39 pF)
- Improved dv/dt Capability

Description

UniFET™ MOSFET is Fairchild Semiconductor®'s high voltage MOSFET family based on planar stripe and DMOS technology. This MOSFET is tailored to reduce on-state resistance, and to provide better switching performance and higher avalanche energy strength. This device family is suitable for switching power converter applications such as power factor correction (PFC), flat panel display (FPD) TV power, ATX and electronic lamp ballasts.

Applications

- PDP TV
- Lighting
- Uninterruptible Power Supply
- AC-DC Power Supply

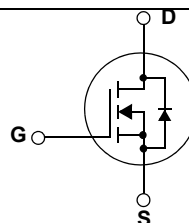
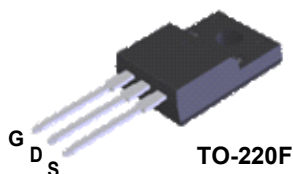

Absolute Maximum Ratings

Symbol	Parameter		FDPF33N25T	Unit
V_{DSS}	Drain-Source Voltage		250	V
I_D	Drain Current	- Continuous ($T_C = 25^\circ\text{C}$)	33*	A
		- Continuous ($T_C = 100^\circ\text{C}$)	20.4*	A
I_{DM}	Drain Current	- Pulsed (Note 1)	132*	A
V_{GSS}	Gate-Source voltage		± 30	V
E_{AS}	Single Pulsed Avalanche Energy (Note 2)		918	mJ
I_{AR}	Avalanche Current (Note 1)		33	A
E_{AR}	Repetitive Avalanche Energy (Note 1)		23.5	mJ
dv/dt	Peak Diode Recovery dv/dt (Note 3)		4.5	V/ns
P_D	Power Dissipation	($T_C = 25^\circ\text{C}$)	37	W
		- Derate above 25°C	0.29	W/°C
T_J, T_{STG}	Operating and Storage Temperature Range		-55 to +150	°C
T_L	Maximum Lead Temperature for Soldering Purpose, 1/8" from Case for 5 Seconds		300	°C

*Drain current limited by maximum junction temperature

Thermal Characteristics

Symbol	Parameter	FDPF33N25T	Unit
$R_{\theta JC}$	Thermal Resistance, Junction-to-Case, Max.	3.4	°C/W
$R_{\theta JA}$	Thermal Resistance, Junction-to-Ambient, Max.	62.5	°C/W

Package Marking and Ordering Information

Device Marking	Device	Package	Reel Size	Tape Width	Quantity
FDPF33N25T	FDPF33N25T	TO-220F	-	-	50

Electrical Characteristics T_C = 25°C unless otherwise noted

Symbol	Parameter	Conditions	Min	Typ	Max	Unit
Off Characteristics						
BV _{DSS}	Drain-Source Breakdown Voltage	V _{GS} = 0V, I _D = 250μA, T _J = 25°C	250	--	--	V
ΔBV _{DSS} / ΔT _J	Breakdown Voltage Temperature Coefficient	I _D = 250μA, Referenced to 25°C	--	0.25	--	V/°C
I _{DSS}	Zero Gate Voltage Drain Current	V _{DS} = 250V, V _{GS} = 0V V _{DS} = 200V, T _C = 125°C	--	--	1 10	μA μA
I _{GSSF}	Gate-Body Leakage Current, Forward	V _{GS} = 30V, V _{DS} = 0V	--	--	100	nA
I _{GSSR}	Gate-Body Leakage Current, Reverse	V _{GS} = -30V, V _{DS} = 0V	--	--	-100	nA
On Characteristics						
V _{GS(th)}	Gate Threshold Voltage	V _{DS} = V _{GS} , I _D = 250μA	3.0	--	5.0	V
R _{DS(on)}	Static Drain-Source On-Resistance	V _{GS} = 10V, I _D = 16.5A	--	0.077	0.094	Ω
g _{FS}	Forward Transconductance	V _{DS} = 40V, I _D = 16.5A	--	26.6	--	S
Dynamic Characteristics						
C _{iss}	Input Capacitance	V _{DS} = 25V, V _{GS} = 0V, f = 1.0MHz	--	1640	2135	pF
C _{oss}	Output Capacitance		--	330	430	pF
C _{rss}	Reverse Transfer Capacitance		--	39	59	pF
Switching Characteristics						
t _{d(on)}	Turn-On Delay Time	V _{DD} = 125V, I _D = 33A R _G = 25Ω	--	35	80	ns
t _r	Turn-On Rise Time		--	230	470	ns
t _{d(off)}	Turn-Off Delay Time		--	75	160	ns
t _f	Turn-Off Fall Time		(Note 4)	--	120	250
Q _g	Total Gate Charge	V _{DS} = 200V, I _D = 33A V _{GS} = 10V	--	36.8	48	nC
Q _{gs}	Gate-Source Charge		--	10	--	nC
Q _{gd}	Gate-Drain Charge		(Note 4)	--	17	--
Drain-Source Diode Characteristics and Maximum Ratings						
I _S	Maximum Continuous Drain-Source Diode Forward Current		--	--	33	A
I _{SM}	Maximum Pulsed Drain-Source Diode Forward Current		--	--	132	A
V _{SD}	Drain-Source Diode Forward Voltage	V _{GS} = 0V, I _S = 33A	--	--	1.4	V
t _{rr}	Reverse Recovery Time	V _{GS} = 0V, I _S = 33A di _F /dt = 100A/μs	--	220	--	ns
Q _{rr}	Reverse Recovery Charge		--	1.71	--	μC

Notes:

1. Repetitive Rating: Pulse width limited by maximum junction temperature
2. L = 1.35mH, I_{AS} = 33A, V_{DD} = 50V, R_G = 25Ω, Starting T_J = 25°C
3. I_{SD} ≤ 33A, di/dt ≤ 200A/μs, V_{DD} ≤ BV_{DSS}, Starting T_J = 25°C
4. Essentially Independent of Operating Temperature Typical Characteristics

Typical Performance Characteristics

Figure 1. On-Region Characteristics

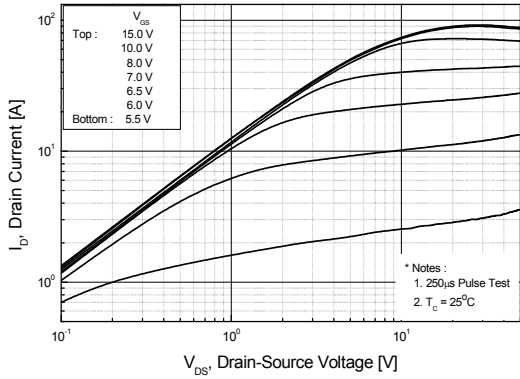

Figure 2. Transfer Characteristics

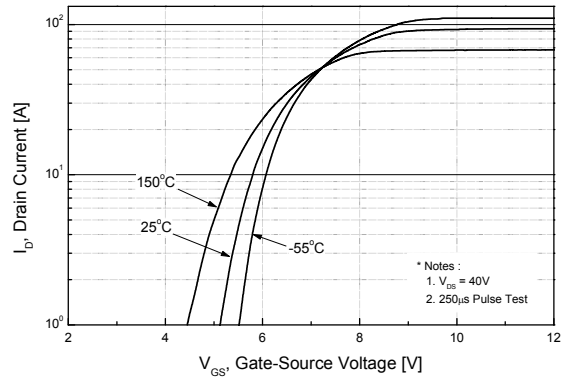

Figure 3. On-Resistance Variation vs. Drain Current and Gate Voltage

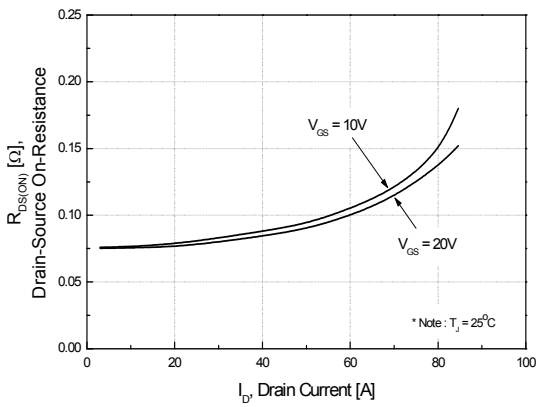

Figure 4. Body Diode Forward Voltage Variation vs. Source Current and Temperature

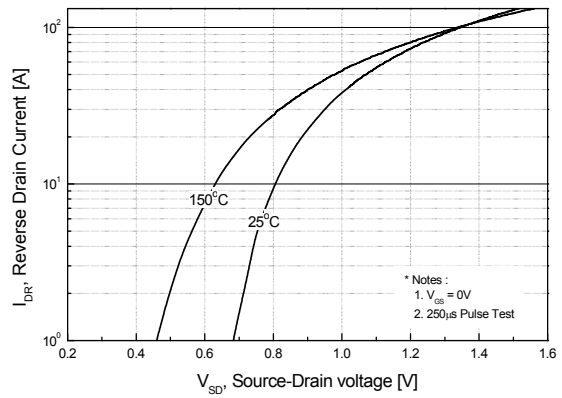

Figure 5. Capacitance Characteristics

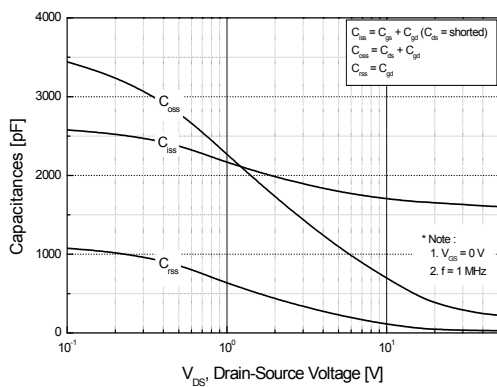
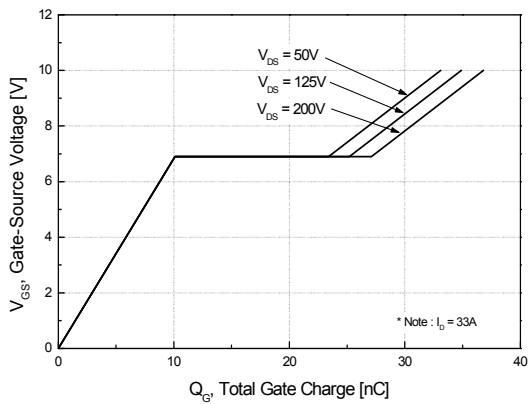

Figure 6. Gate Charge Characteristics



Typical Performance Characteristics (Continued)

Figure 7. Breakdown Voltage Variation vs. Temperature

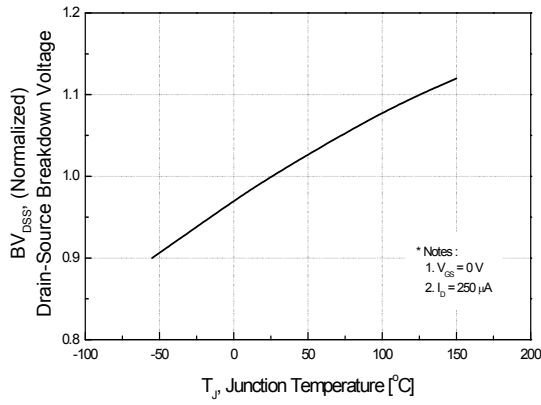

Figure 8. On-Resistance Variation vs. Temperature

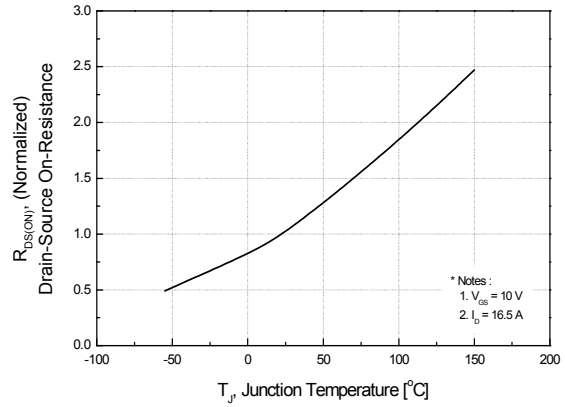

Figure 9. Maximum Safe Operating Area

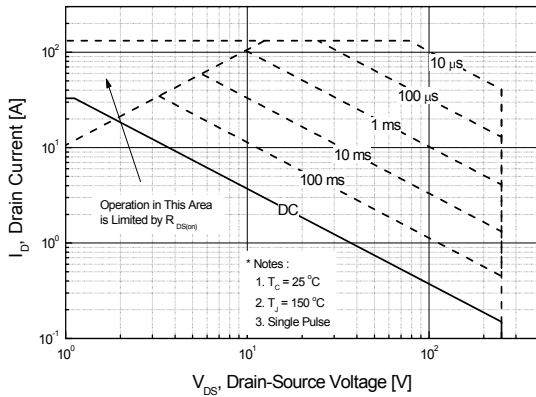

Figure 10. Maximum Drain Current vs. Case Temperature

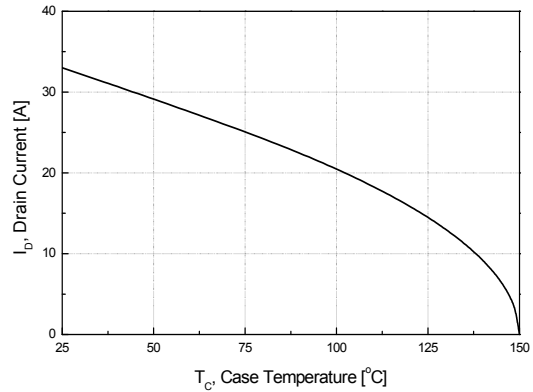
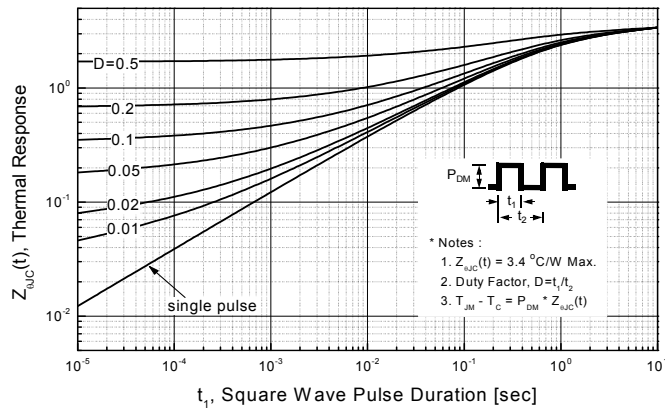
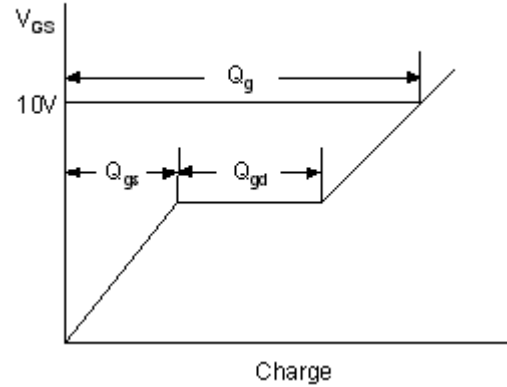
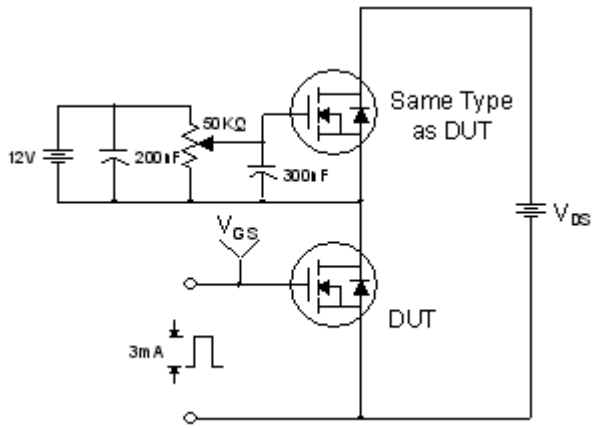

Figure 11. Transient Thermal Response Curve



Gate Charge Test Circuit & Waveform



Resistive Switching Test Circuit & Waveforms

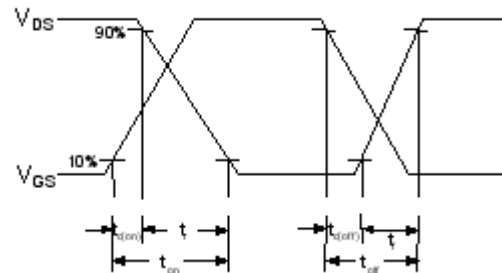
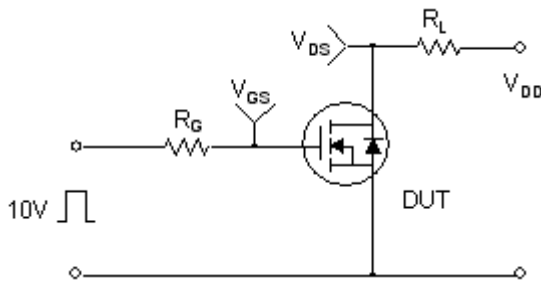

Unclamped Inductive Switching Test Circuit & Waveforms

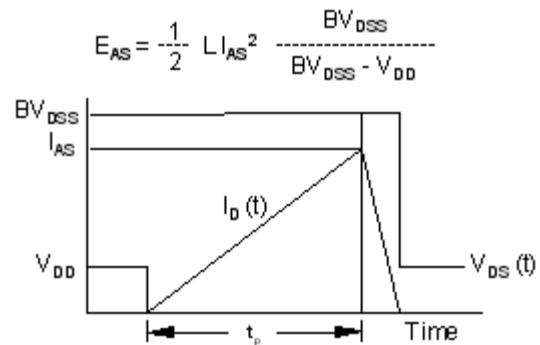
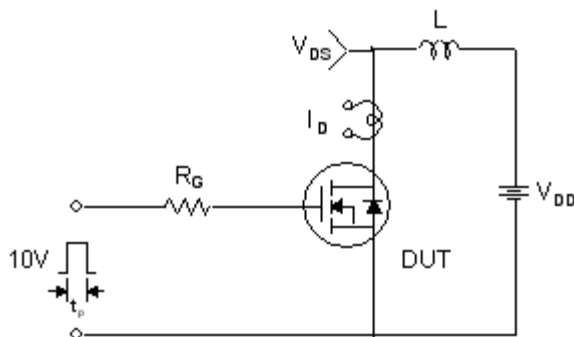

Peak Diode Recovery dv/dt Test Circuit & Waveforms





TRADEMARKS

The following includes registered and unregistered trademarks and service marks, owned by Fairchild Semiconductor and/or its global subsidiaries, and is not intended to be an exhaustive list of all such trademarks.

- | | | | |
|--------------------------|---|---|--------------------------|
| 2Cool™ | FPS™ | PowerTrench® | Sync-Lock™ |
| AccuPower™ | F-PFS™ | PowerXS™ | SYSTEM GENERAL ®* |
| AX-CAP®* | FRFET® | Programmable Active Droop™ | TinyBoost™ |
| BitSiC™ | Global Power Resource SM | QFET® | TinyBuck™ |
| Build it Now™ | Green Bridge™ | QS™ | TinyCalc™ |
| CorePLUS™ | Green FPS™ | Quiet Series™ | TinyLogic® |
| CorePOWER™ | Green FPS™ e-Series™ | RapidConfigure™ | TINYOPTO™ |
| CROSSVOLT™ | Gmax™ | IntelliMAX™ | TinyPower™ |
| CTL™ | GTO™ | ISOPLANAR™ | TinyPWM™ |
| Current Transfer Logic™ | IntelliMAX™ | Marking Small Speakers Sound Louder and Better™ | TinyWire™ |
| DEUXPEED® | ISOPANAR™ | MegaBuck™ | TranSiC® |
| Dual Cool™ | Marking Small Speakers Sound Louder and Better™ | MICROCOUPLER™ | TriFault Detect™ |
| EcoSPARK® | MegaBuck™ | MicroFET™ | TRUECURRENT®* |
| EfficientMax™ | MICROCOUPLER™ | MicroPak™ | µSerDes™ |
| ESBC™ | MicroFET™ | MicroPak2™ | µSerDes™ |
| F ® | MicroPak™ | MillerDrive™ | UHC® |
| Fairchild® | MicroPak2™ | MotionMax™ | Ultra FRFET™ |
| Fairchild Semiconductor® | MillerDrive™ | mWSaver™ | UNiFET™ |
| FACT Quiet Series™ | MotionMax™ | OptoHit™ | VCX™ |
| FACT® | mWSaver™ | OPTOLOGIC® | VisualMax™ |
| FAST® | OptoHit™ | OPTOPLANAR® | VoltagePlus™ |
| FastvCore™ | OPTOLOGIC® | PowerTrench® | XS™ |
| FETBench™ | OPTOPLANAR® | PowerXS™ | |
| | | Programmable Active Droop™ | |
| | | QFET® | |
| | | QS™ | |
| | | Quiet Series™ | |
| | | RapidConfigure™ | |
| | | IntelliMAX™ | |
| | | ISOPLANAR™ | |
| | | Marking Small Speakers Sound Louder and Better™ | |
| | | MegaBuck™ | |
| | | MICROCOUPLER™ | |
| | | MicroFET™ | |
| | | MicroPak™ | |
| | | MicroPak2™ | |
| | | MillerDrive™ | |
| | | MotionMax™ | |
| | | mWSaver™ | |
| | | OptoHit™ | |
| | | OPTOLOGIC® | |
| | | OPTOPLANAR® | |
| | | PowerTrench® | |
| | | PowerXS™ | |
| | | Programmable Active Droop™ | |
| | | QFET® | |
| | | QS™ | |
| | | Quiet Series™ | |
| | | RapidConfigure™ | |
| | | IntelliMAX™ | |
| | | ISOPLANAR™ | |
| | | Marking Small Speakers Sound Louder and Better™ | |
| | | MegaBuck™ | |
| | | MICROCOUPLER™ | |
| | | MicroFET™ | |
| | | MicroPak™ | |
| | | MicroPak2™ | |
| | | MillerDrive™ | |
| | | MotionMax™ | |
| | | mWSaver™ | |
| | | OptoHit™ | |
| | | OPTOLOGIC® | |
| | | OPTOPLANAR® | |
| | | PowerTrench® | |
| | | PowerXS™ | |
| | | Programmable Active Droop™ | |
| | | QFET® | |
| | | QS™ | |
| | | Quiet Series™ | |
| | | RapidConfigure™ | |
| | | IntelliMAX™ | |
| | | ISOPLANAR™ | |
| | | Marking Small Speakers Sound Louder and Better™ | |
| | | MegaBuck™ | |
| | | MICROCOUPLER™ | |
| | | MicroFET™ | |
| | | MicroPak™ | |
| | | MicroPak2™ | |
| | | MillerDrive™ | |
| | | MotionMax™ | |
| | | mWSaver™ | |
| | | OptoHit™ | |
| | | OPTOLOGIC® | |
| | | OPTOPLANAR® | |
| | | PowerTrench® | |
| | | PowerXS™ | |
| | | Programmable Active Droop™ | |
| | | QFET® | |
| | | QS™ | |
| | | Quiet Series™ | |
| | | RapidConfigure™ | |
| | | IntelliMAX™ | |
| | | ISOPLANAR™ | |
| | | Marking Small Speakers Sound Louder and Better™ | |
| | | MegaBuck™ | |
| | | MICROCOUPLER™ | |
| | | MicroFET™ | |
| | | MicroPak™ | |
| | | MicroPak2™ | |
| | | MillerDrive™ | |
| | | MotionMax™ | |
| | | mWSaver™ | |
| | | OptoHit™ | |
| | | OPTOLOGIC® | |
| | | OPTOPLANAR® | |
| | | PowerTrench® | |
| | | PowerXS™ | |
| | | Programmable Active Droop™ | |
| | | QFET® | |
| | | QS™ | |
| | | Quiet Series™ | |
| | | RapidConfigure™ | |
| | | IntelliMAX™ | |
| | | ISOPLANAR™ | |
| | | Marking Small Speakers Sound Louder and Better™ | |
| | | MegaBuck™ | |
| | | MICROCOUPLER™ | |
| | | MicroFET™ | |
| | | MicroPak™ | |
| | | MicroPak2™ | |
| | | MillerDrive™ | |
| | | MotionMax™ | |
| | | mWSaver™ | |
| | | OptoHit™ | |
| | | OPTOLOGIC® | |
| | | OPTOPLANAR® | |
| | | PowerTrench® | |
| | | PowerXS™ | |
| | | Programmable Active Droop™ | |
| | | QFET® | |
| | | QS™ | |
| | | Quiet Series™ | |
| | | RapidConfigure™ | |
| | | IntelliMAX™ | |
| | | ISOPLANAR™ | |
| | | Marking Small Speakers Sound Louder and Better™ | |
| | | MegaBuck™ | |
| | | MICROCOUPLER™ | |
| | | MicroFET™ | |
| | | MicroPak™ | |
| | | MicroPak2™ | |
| | | MillerDrive™ | |
| | | MotionMax™ | |
| | | mWSaver™ | |
| | | OptoHit™ | |
| | | OPTOLOGIC® | |
| | | OPTOPLANAR® | |
| | | PowerTrench® | |
| | | PowerXS™ | |
| | | Programmable Active Droop™ | |
| | | QFET® | |
| | | QS™ | |
| | | Quiet Series™ | |
| | | RapidConfigure™ | |
| | | IntelliMAX™ | |
| | | ISOPLANAR™ | |
| | | Marking Small Speakers Sound Louder and Better™ | |
| | | MegaBuck™ | |
| | | MICROCOUPLER™ | |
| | | MicroFET™ | |
| | | MicroPak™ | |
| | | MicroPak2™ | |
| | | MillerDrive™ | |
| | | MotionMax™ | |
| | | mWSaver™ | |
| | | OptoHit™ | |
| | | OPTOLOGIC® | |
| | | OPTOPLANAR® | |
| | | PowerTrench® | |
| | | PowerXS™ | |
| | | Programmable Active Droop™ | |
| | | QFET® | |
| | | QS™ | |
| | | Quiet Series™ | |
| | | RapidConfigure™ | |
| | | IntelliMAX™ | |
| | | ISOPLANAR™ | |
| | | Marking Small Speakers Sound Louder and Better™ | |
| | | MegaBuck™ | |
| | | MICROCOUPLER™ | |
| | | MicroFET™ | |
| | | MicroPak™ | |
| | | MicroPak2™ | |
| | | MillerDrive™ | |
| | | MotionMax™ | |
| | | mWSaver™ | |
| | | OptoHit™ | |
| | | OPTOLOGIC® | |
| | | OPTOPLANAR® | |
| | | PowerTrench® | |
| | | PowerXS™ | |
| | | Programmable Active Droop™ | |
| | | QFET® | |
| | | QS™ | |
| | | Quiet Series™ | |
| | | RapidConfigure™ | |
| | | IntelliMAX™ | |
| | | ISOPLANAR™ | |
| | | Marking Small Speakers Sound Louder and Better™ | |
| | | MegaBuck™ | |
| | | MICROCOUPLER™ | |
| | | MicroFET™ | |
| | | MicroPak™ | |
| | | MicroPak2™ | |
| | | MillerDrive™ | |
| | | MotionMax™ | |
| | | mWSaver™ | |
| | | OptoHit™ | |
| | | OPTOLOGIC® | |
| | | OPTOPLANAR® | |
| | | PowerTrench® | |
| | | PowerXS™ | |
| | | Programmable Active Droop™ | |
| | | QFET® | |
| | | QS™ | |
| | | Quiet Series™ | |
| | | RapidConfigure™ | |
| | | IntelliMAX™ | |
| | | ISOPLANAR™ | |
| | | Marking Small Speakers Sound Louder and Better™ | |
| | | MegaBuck™ | |
| | | MICROCOUPLER™ | |
| | | MicroFET™ | |
| | | MicroPak™ | |
| | | MicroPak2™ | |
| | | MillerDrive™ | |
| | | MotionMax™ | |
| | | mWSaver™ | |
| | | OptoHit™ | |
| | | OPTOLOGIC® | |
| | | OPTOPLANAR® | |
| | | PowerTrench® | |
| | | PowerXS™ | |
| | | Programmable Active Droop™ | |
| | | QFET® | |
| | | QS™ | |
| | | Quiet Series™ | |
| | | RapidConfigure™ | |
| | | IntelliMAX™ | |
| | | ISOPLANAR™ | |
| | | Marking Small Speakers Sound Louder and Better™ | |
| | | MegaBuck™ | |
| | | MICROCOUPLER™ | |
| | | MicroFET™ | |
| | | MicroPak™ | |
| | | MicroPak2™ | |
| | | MillerDrive™ | |
| | | MotionMax™ | |
| | | mWSaver™ | |
| | | OptoHit™ | |
| | | OPTOLOGIC® | |
| | | OPTOPLANAR® | |
| | | PowerTrench® | |
| | | PowerXS™ | |
| | | Programmable Active Droop™ | |
| | | QFET® | |
| | | QS™ | |
| | | Quiet Series™ | |
| | | RapidConfigure™ | |
| | | IntelliMAX™ | |
| | | ISOPLANAR™ | |
| | | Marking Small Speakers Sound Louder and Better™ | |
| | | MegaBuck™ | |
| | | MICROCOUPLER™ | |
| | | MicroFET™ | |
| | | MicroPak™ | |
| | | MicroPak2™ | |
| | | MillerDrive™ | |
| | | MotionMax™ | |
| | | mWSaver™ | |
| | | OptoHit™ | |
| | | OPTOLOGIC® | |
| | | OPTOPLANAR® | |
| | | PowerTrench® | |
| | | PowerXS™ | |
| | | Programmable Active Droop™ | |
| | | QFET® | |
| | | QS™ | |
| | | Quiet Series™ | |
| | | RapidConfigure™ | |
| | | IntelliMAX™ | |
| | | ISOPLANAR™ | |
| | | Marking Small Speakers Sound Louder and Better™ | |
| | | MegaBuck™ | |
| | | MICROCOUPLER™ | |
| | | MicroFET™ | |
| | | MicroPak™ | |
| | | MicroPak2™ | |
| | | MillerDrive™ | |
| | | MotionMax™ | |
| | | mWSaver™ | |
| | | OptoHit™ | |
| | | OPTOLOGIC® | |
| | | OPTOPLANAR® | |
| | | PowerTrench® | |
| | | PowerXS™ | |
| | | Programmable Active Droop™ | |
| | | QFET® | |
| | | QS™ | |
| | | Quiet Series™ | |
| | | RapidConfigure™ | |
| | | IntelliMAX™ | |
| | | ISOPLANAR™ | |
| | | Marking Small Speakers Sound Louder and Better™ | |
| | | MegaBuck™ | |
| | | MICROCOUPLER™ | |
| | | MicroFET™ | |
| | | MicroPak™ | |
| | | MicroPak2™ | |
| | | MillerDrive™ | |
| | | MotionMax™ | |
| | | mWSaver™ | |
| | | OptoHit™ | |
| | | OPTOLOGIC® | |
| | | OPTOPLANAR® | |
| | | PowerTrench® | |
| | | PowerXS™ | |
| | | Programmable Active Droop™ | |
| | | QFET® | |
| | | QS™ | |
| | | Quiet Series™ | |
| | | RapidConfigure™ | |
| | | IntelliMAX™ | |
| | | ISOPLANAR™ | |
| | | Marking Small Speakers Sound Louder and Better™ | |
| | | MegaBuck™ | |
| | | MICROCOUPLER™ | |
| | | MicroFET™ | |
| | | MicroPak™ | |
| | | MicroPak2™ | |
| | | MillerDrive™ | |
| | | MotionMax™ | |
| | | mWSaver™ | |
| | | OptoHit™ | |
| | | OPTOLOGIC® | |
| | | OPTOPLANAR® | |
| | | PowerTrench® | |
| | | PowerXS™ | |
| | | Programmable Active Droop™ | |
| | | QFET® | |
| | | QS™ | |
| | | Quiet Series™ | |
| | | RapidConfigure™ | |
| | | IntelliMAX™ | |
| | | ISOPLANAR™ | |
| | | Marking Small Speakers Sound Louder and Better™ | |
| | | MegaBuck™ | |
| | | MICROCOUPLER™ | |
| | | MicroFET™ | |
| | | MicroPak™ | |
| | | MicroPak2™ | |
| | | MillerDrive™ | |
| | | MotionMax™ | |
| | | mWSaver™ | |
| | | OptoHit™ | |
| | | OPTOLOGIC® | |
| | | OPTOPLANAR® | |
| | | PowerTrench® | |
| | | PowerXS™ | |
| | | Programmable Active Droop™ | |
| | | QFET® | |
| | | QS™ | |
| | | Quiet Series™ | |
| | | RapidConfigure™ | </ |