

CMPA5585025F

25 W, 5.5 - 8.5 GHz, GaN MMIC, Power Amplifier

Cree's CMPA5585025F is a gallium nitride (GaN) High Electron Mobility Transistor (HEMT) based monolithic microwave integrated circuit (MMIC). GaN has superior properties compared to silicon or gallium arsenide, including higher breakdown voltage, higher saturated electron drift velocity and higher thermal conductivity. GaN HEMTs also offer greater power density and wider bandwidths compared to Si and GaAs transistors. This MMIC is available in a 10 lead metal/ceramic flanged package for optimal electrical and thermal performance.

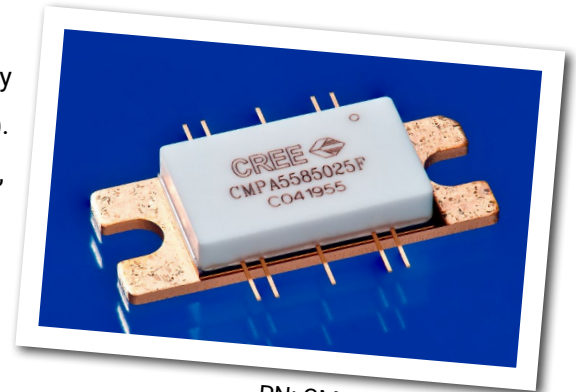

PN: CMPA5585025F
Package Type: 440208

Typical Performance Over 5.8-8.4 GHz ($T_c = 25^\circ\text{C}$)

| Parameter | 5.8 GHz | 6.4 GHz | 7.2 GHz | 7.9 GHz | 8.4 GHz | Units |
|-------------------------------------|---------|---------|---------|---------|---------|-------|
| Small Signal Gain | 29.5 | 24.0 | 24.0 | 24.0 | 22.0 | dB |
| Output Power ¹ | 15 | 23 | 20 | 19 | 19 | W |
| Power Gain ¹ | 21.7 | 19.5 | 17.2 | 18.5 | 18.6 | dB |
| Power Added Efficiency ¹ | 30 | 25 | 20.5 | 19 | 19.5 | % |

Note¹: Measured at -30 dBc, 1.6 MHz from carrier, in the CMPA5585025F-AMP under OQPSK modulation, 1.6 Msps, PN23, Alpha Filter = 0.2.

Features

- 25 dB Small Signal Gain
- 35 W Typical P_{SAT}
- Operation up to 28 V
- High Breakdown Voltage
- High Temperature Operation
- Size 1.00 x 0.385 inches

Applications

- Point to Point Radio
- Communications
- Satellite Communication Uplink

Absolute Maximum Ratings (not simultaneous)

| Parameter | Symbol | Rating | Units | Conditions |
|--------------------------------------|------------|-----------|----------|--------------------------------|
| Drain-source Voltage | V_{DSS} | 84 | V_{DC} | 25°C |
| Gate-source Voltage | V_{GS} | -10, +2 | V_{DC} | 25°C |
| Power Dissipation | P_{DISS} | 55 | W | |
| Storage Temperature | T_{STG} | -65, +150 | °C | |
| Operating Junction Temperature | T_J | 225 | °C | |
| Maximum Forward Gate Current | I_{GMAX} | 10 | mA | 25°C |
| Soldering Temperature ¹ | T_S | 245 | °C | |
| Screw Torque | τ | 40 | in-oz | |
| Thermal Resistance, Junction to Case | R_{JUC} | 1.55 | °C/W | OQPSK, 85°C, $P_{DISS} = 55$ W |
| Thermal Resistance, Junction to Case | R_{JUC} | 1.80 | °C/W | CW, 85°C, $P_{DISS} = 77$ W |
| Case Operating Temperature | T_C | -40, +140 | °C | $P_{DISS} = 55$ W |
| Case Operating Temperature | T_C | -40, +85 | °C | $P_{DISS} = 77$ W |

Note:

¹ Refer to the Application Note on soldering at www.cree.com/RF/Document-Library

Electrical Characteristics (Frequency = 5.5 GHz to 8.5 GHz unless otherwise stated; $T_C = 25^\circ\text{C}$)

| Characteristics | Symbol | Min. | Typ. | Max. | Units | Conditions |
|---------------------------------------|--------------|-------|------|------|----------|---|
| DC Characteristics¹ | | | | | | |
| Gate Threshold Voltage | $V_{GS(TH)}$ | -3.8 | -3.0 | -2.3 | V | $V_{DS} = 10$ V, $I_D = 13.2$ mA |
| Gate Quiescent Voltage | $V_{GS(Q)}$ | - | -2.7 | - | V_{DC} | $V_{DS} = 28$ V, $I_D = 285$ mA |
| Saturated Drain Current ² | I_{DS} | 10.6 | 12.8 | - | A | $V_{DS} = 6.0$ V, $V_{GS} = 2.0$ V |
| Drain-Source Breakdown Voltage | V_{BD} | 84 | 100 | - | V | $V_{GS} = -8$ V, $I_D = 13.2$ mA |
| RF Characteristics³ | | | | | | |
| Small Signal Gain | S21 | 18.25 | 24 | - | dB | $V_{DD} = 28$ V, $I_{DQ} = 285$ mA, $P_{IN} = -20$ dBm |
| Input Return Loss | S11 | - | 10 | - | dB | $V_{DD} = 28$ V, $I_{DQ} = 285$ mA |
| Output Return Loss | S22 | - | 6 | - | dB | $V_{DD} = 28$ V, $I_{DQ} = 285$ mA |
| Output Mismatch Stress | VSWR | - | - | 5:1 | Ψ | No damage at all phase angles, $V_{DD} = 28$ V, $I_{DQ} = 285$ mA, $P_{OUT} = 25$ W OQPSK |

Notes:

¹ Measured on-wafer prior to packaging.

² Scaled from PCM data.

³ Measured in the CMPA5585025F-AMP

Electrical Characteristics Continued... (T_c = 25°C)

| Characteristics | Symbol | Min. | Typ. | Max. | Units | Conditions |
|---|-----------------|-------|------|-------|-------|---|
| RF Characteristics^{1,2,3,4} | | | | | | |
| Power Added Efficiency | PAE1 | 24.5 | 30.0 | – | % | V _{DD} = 28 V, I _{DQ} = 285 mA, Frequency = 5.8 GHz |
| Power Added Efficiency | PAE2 | 16.5 | 20.5 | – | % | V _{DD} = 28 V, I _{DQ} = 285 mA, Frequency = 7.2 GHz |
| Power Added Efficiency | PAE3 | 15.5 | 19.0 | – | % | V _{DD} = 28 V, I _{DQ} = 285 mA, Frequency = 7.9 GHz |
| Power Added Efficiency | PAE4 | 15.0 | 19.5 | – | % | V _{DD} = 28 V, I _{DQ} = 285 mA, Frequency = 8.4 GHz |
| Power Gain | G _{P1} | 19.5 | 21.7 | – | dB | V _{DD} = 28 V, I _{DQ} = 285 mA, Frequency = 5.8 GHz |
| Power Gain | G _{P2} | 16.25 | 17.2 | – | dB | V _{DD} = 28 V, I _{DQ} = 285 mA, Frequency = 7.2 GHz |
| Power Gain | G _{P3} | 16.55 | 18.5 | – | dB | V _{DD} = 28 V, I _{DQ} = 285 mA, Frequency = 7.9 GHz |
| Power Gain | G _{P4} | 16.75 | 18.6 | – | dB | V _{DD} = 28 V, I _{DQ} = 285 mA, Frequency = 8.4 GHz |
| OQPSK Linearity | ACLR1 | – | -36 | -27.0 | dB | V _{DD} = 28 V, I _{DQ} = 285 mA, Frequency = 5.8 GHz |
| OQPSK Linearity | ACLR2 | – | -36 | -28.5 | dB | V _{DD} = 28 V, I _{DQ} = 285 mA, Frequency = 7.2 GHz |
| OQPSK Linearity | ACLR3 | – | -36 | -26.0 | dB | V _{DD} = 28 V, I _{DQ} = 285 mA, Frequency = 7.9 GHz |
| OQPSK Linearity | ACLR4 | – | -42 | -32.5 | dB | V _{DD} = 28 V, I _{DQ} = 285 mA, Frequency = 8.4 GHz |

Notes:

¹ Measured in the CMPA5585025F-AMP

² Under OQPSK modulated signal, 1.6 Msps, PN23, Alpha Filter = 0.2.

³ Measured at P_{AVE} = 40 dBm.

⁴ Fixture loss de-embedded.

Electrostatic Discharge (ESD) Classifications

| Parameter | Symbol | Class | Test Methodology |
|---------------------|--------|------------------|---------------------|
| Human Body Model | HBM | 1A (> 250 V) | JEDEC JESD22 A114-D |
| Charge Device Model | CDM | II (200 < 500 V) | JEDEC JESD22 C101-C |

Typical Performance of the CMPA5585025F

Figure 1. CMPA5585025F Linear Output Power, Gain and PAE at -30 dBc, 1.6 MHz from carrier
 $V_{DD} = 28\text{ V}$, $I_{DQ} = 285\text{ mA}$, 1.6 Mps OQPSK Modulation

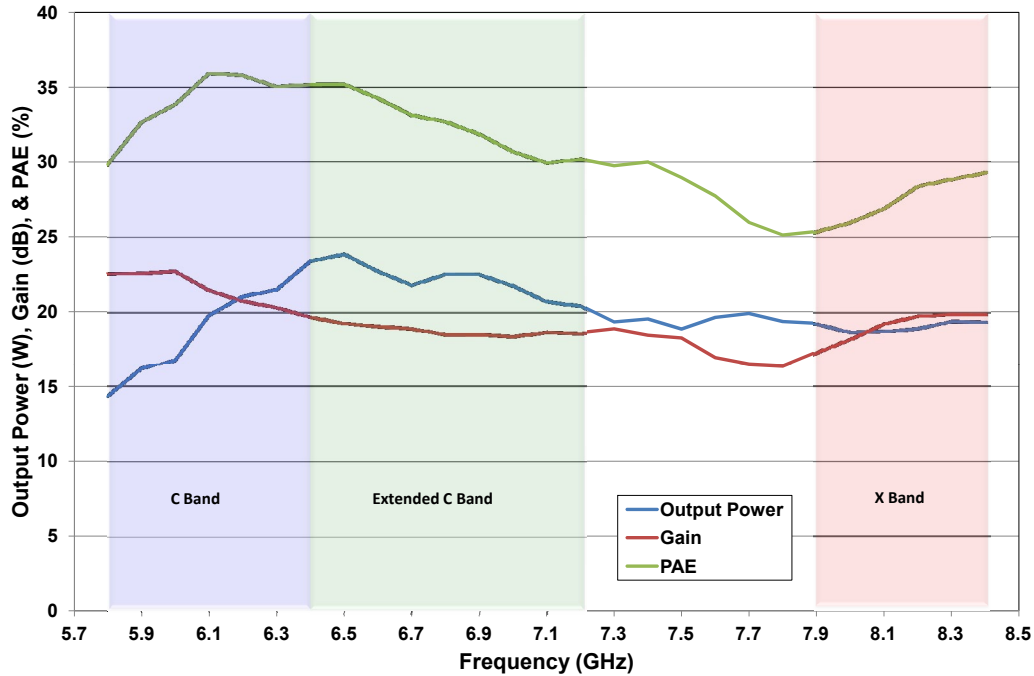
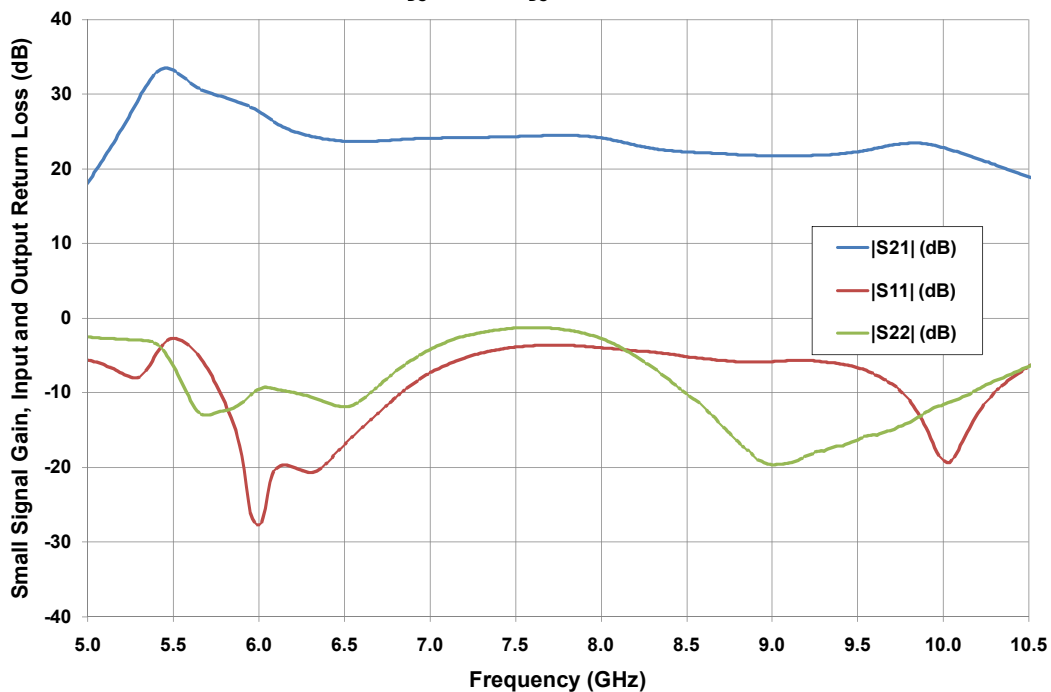

Figure 2. Typical Small Signal Gain and Return Loss vs Frequency of the CMPA5585025F measured in CMPA5585025F-AMP Amplifier Circuit.

$V_{DS} = 28\text{ V}$, $I_{DS} = 285\text{ mA}$



Typical Performance of the CMPA5585025F

Figure 3. CMPA5585025F C-band Spectral Mask at 15 W
 PAE = 29.1% at 5.8 GHz, 28.5% at 6.4 GHz & 25.6% at 7.2 GHz

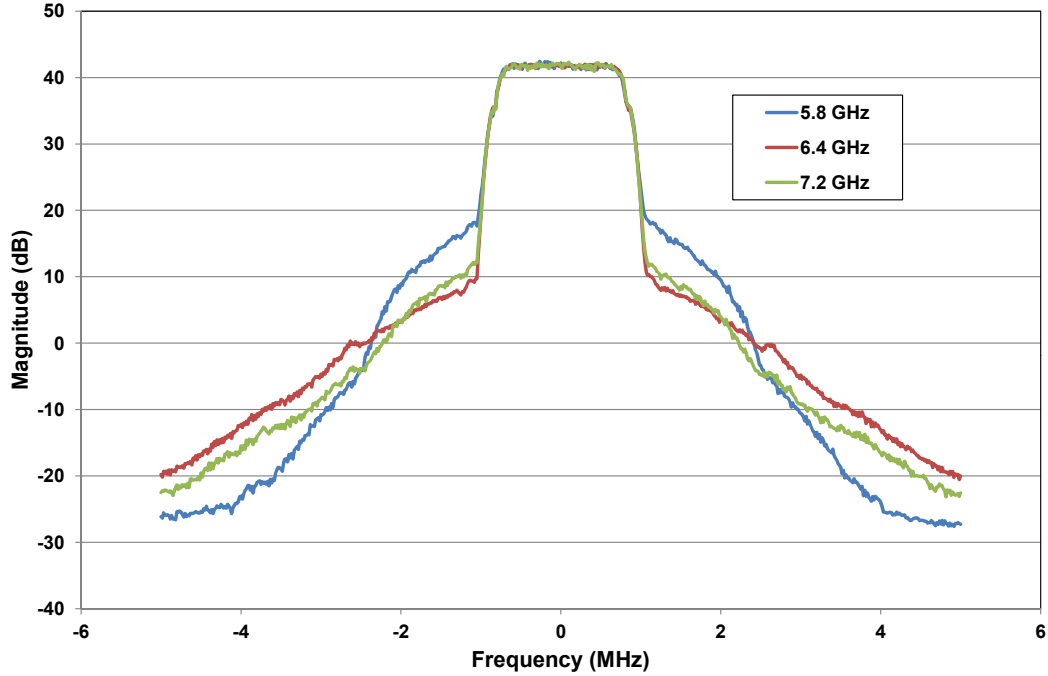
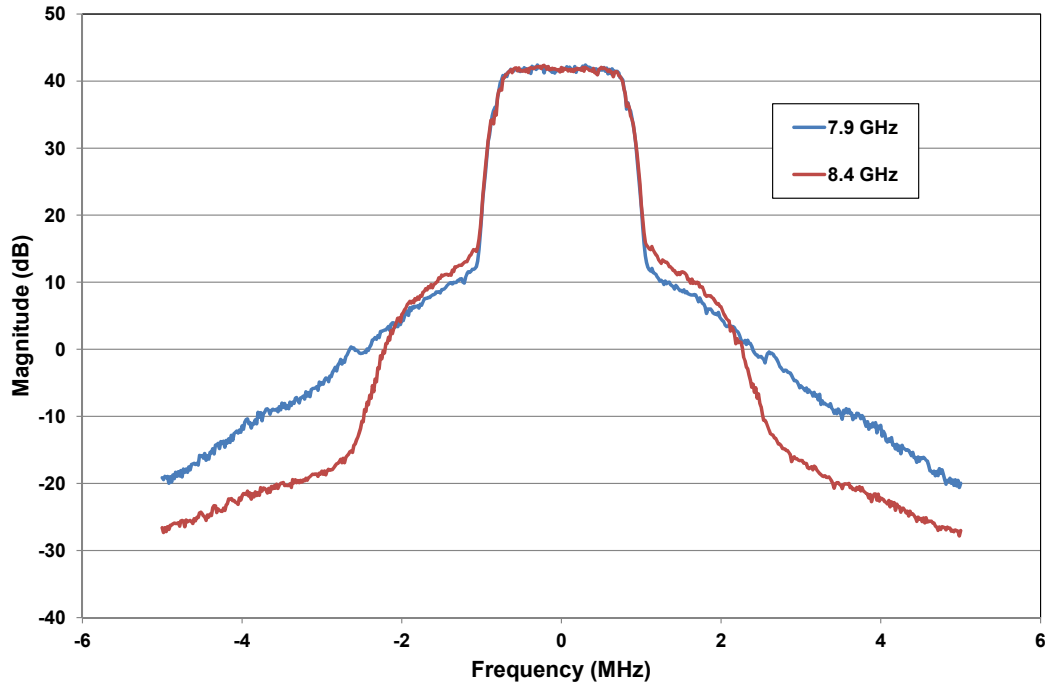

Figure 4. CMPA5585025F X-band Spectral Mask at 15 W
 PAE = 25.6% at 7.9 GHz & 25.3% at 8.4 GHz



Typical Performance of the CMPA5585025F

Figure 5. CMPA5585025F C-band Linearity, Gain, and PAE vs Average Output Power
 $V_{DS} = 28\text{ V}$, $I_{DS} = 285\text{ mA}$, OQPSK, 1.6 Msps

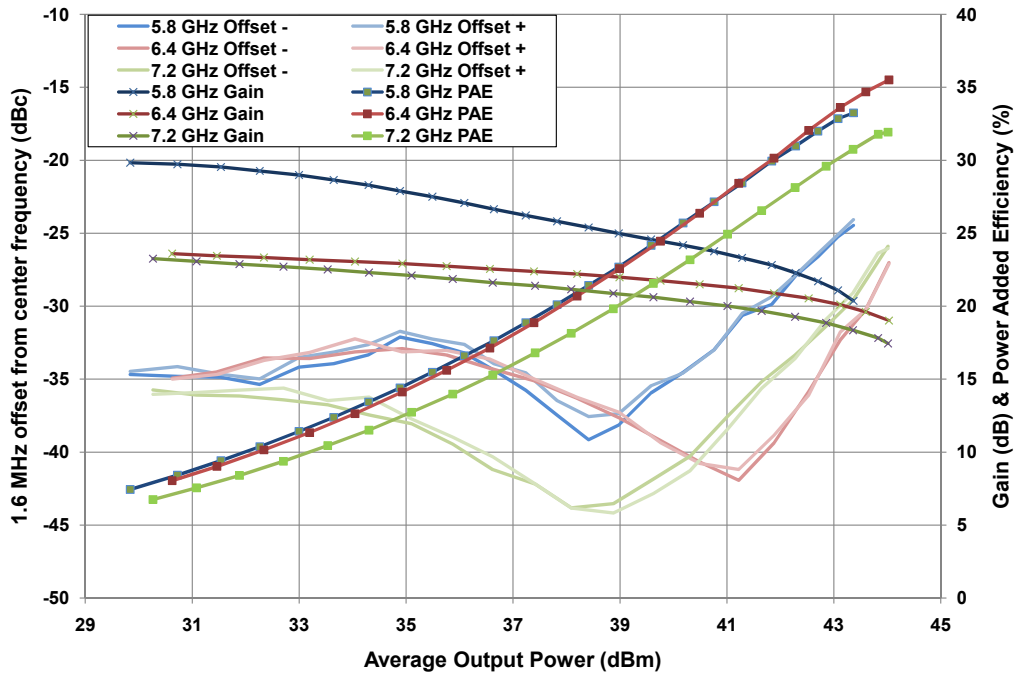
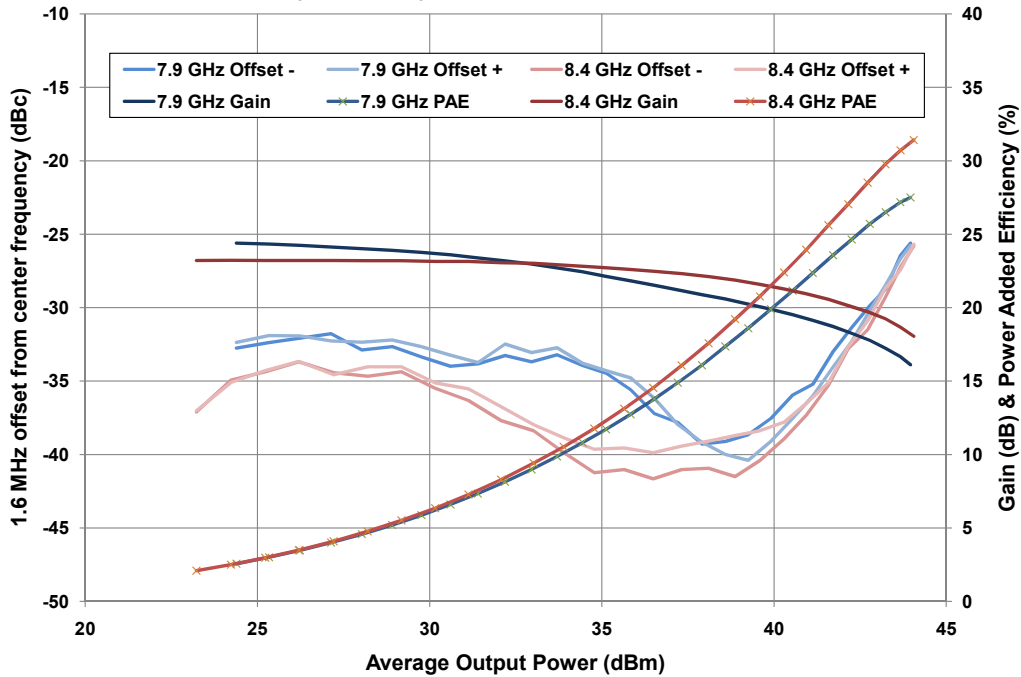

Figure 6. CMPA5585025F X-band Linearity, Gain, and PAE vs Average Output Power
 $V_{DS} = 28\text{ V}$, $I_{DS} = 285\text{ mA}$, OQPSK, 1.6 Msps



Typical Performance of the CMPA5585025F

Figure 7. CMPA5585025F EVM vs Average Output Power
 $V_{DS} = 28\text{ V}$, $I_{DS} = 285\text{ mA}$, 1.6 Msps OQPSK Modulation

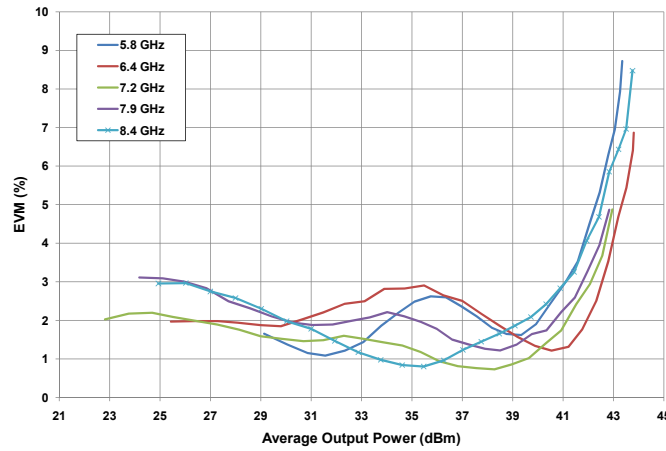

Figure 8. CMPA5585025F - Linearity vs Average Output Power
 OQPSK, 1.6 Msps, $I_{DS} = 285\text{ mA}$

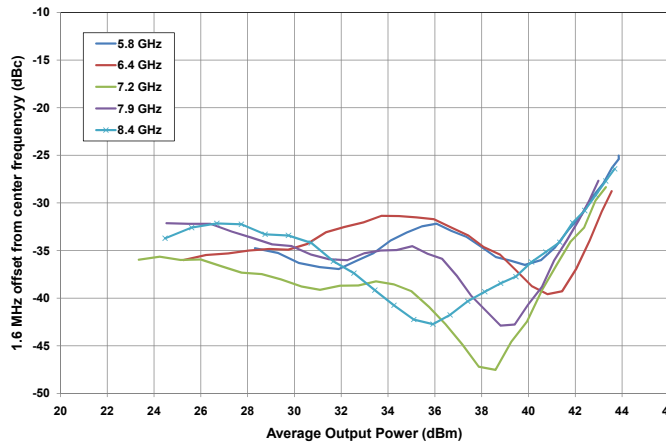
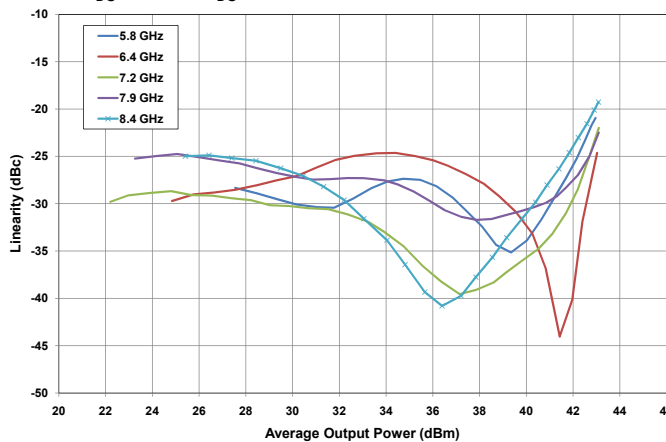

Figure 9. CMPA5585025F Linearity vs Average Output Power
 $V_{DS} = 28\text{ V}$, $I_{DS} = 285\text{ mA}$, IM3 5 MHz spacing



Typical Performance of the CMPA5585025F

Figure 10. CMPA5585025F - C-band Output Power, Gain and PAE vs Input Power
 $V_{DS} = 28\text{ V}, I_{DS} = 1.2\text{ A, CW}$

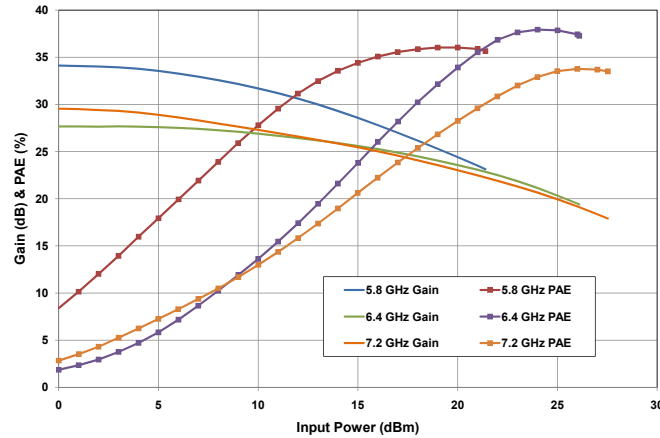

Figure 11. CMPA5585025F - X-band Output Power, Gain and PAE vs Input Power
 $V_{DS} = 28\text{ V}, I_{DS} = 1.2\text{ A, CW}$

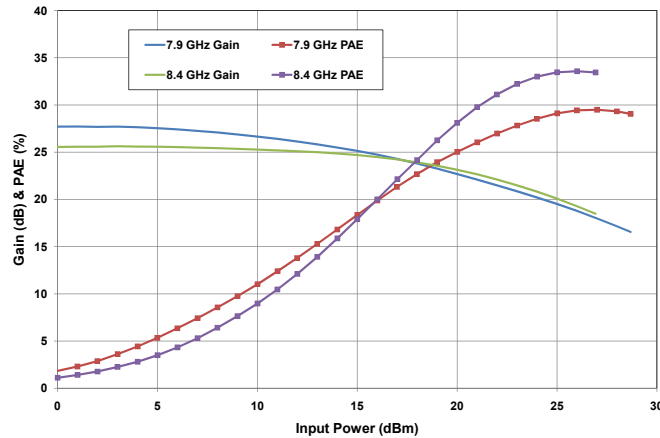
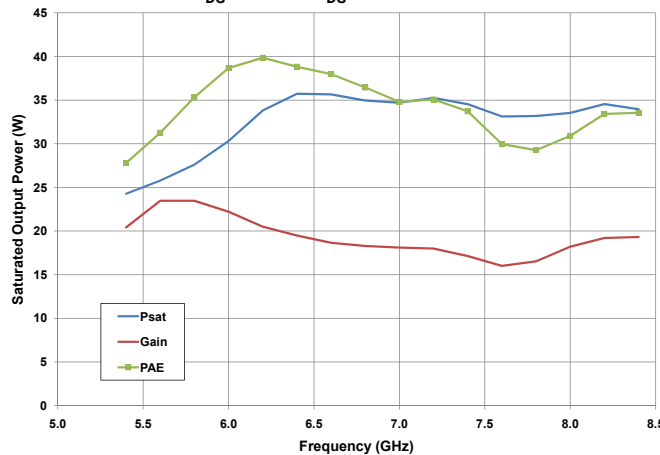

Figure 12. CMPA5585025F - Power, Gain and PAE vs Frequency
 $V_{DS} = 28\text{ V}, I_{DS} = 1.2\text{ A, CW}$



Typical Performance of the CMPA5585025F

Figure 13. CMPA5585025F - Typical Drain Current vs Average Output Power
 $V_{DS} = 28\text{ V}$, $I_{DS} = 285\text{ mA}$, OQPSK, 1.6 Msps

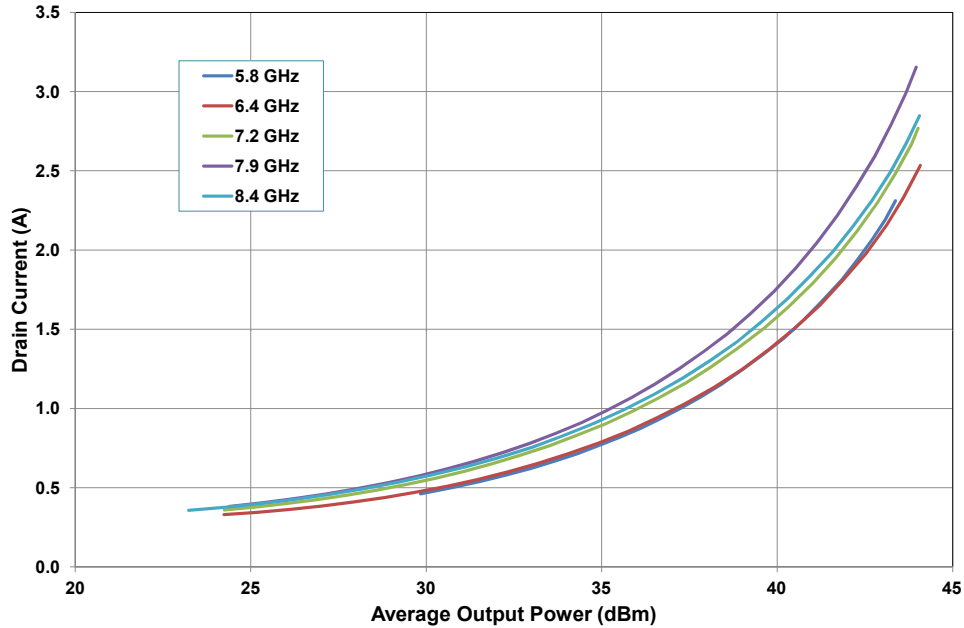
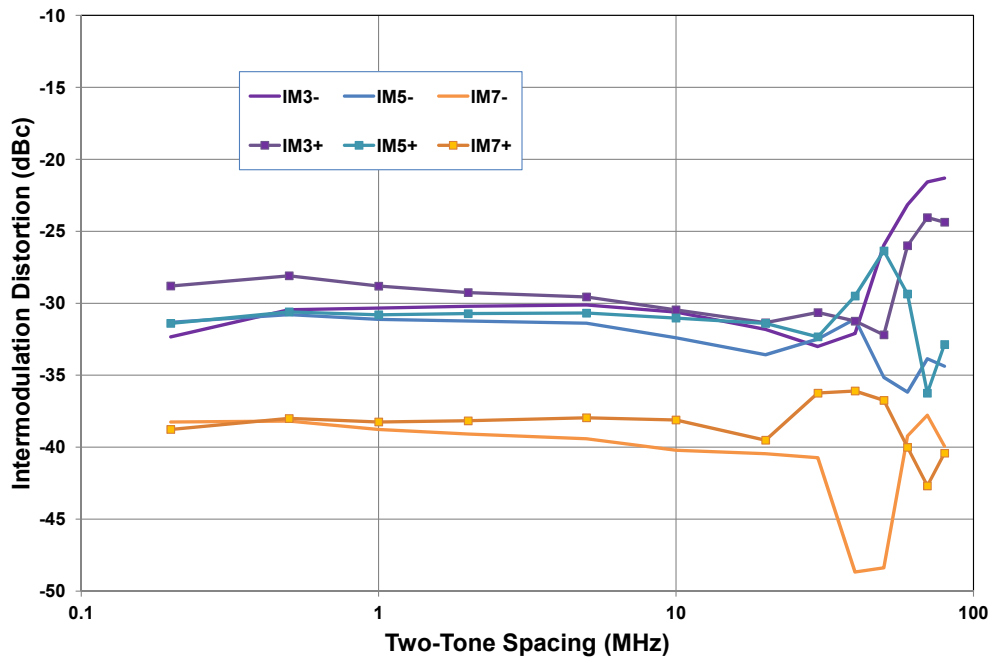

Figure 14. CMPA5585025F - Intermodulation Distortion Products vs Tone Spacing
 $V_{DS} = 28\text{ V}$, $I_{DS} = 285\text{ mA}$, Center Freq = 7.9 GHz



Note: Divergence in IM5 and IM7 at tone spacings greater than 20 MHz is due to the bias components on the test fixture.

Typical Performance of the CMPA5585025F

Figure 15. CMPA5585025F - AM-AM
 $V_{DS} = 28\text{ V}, I_{DS} = 285\text{ mA}$

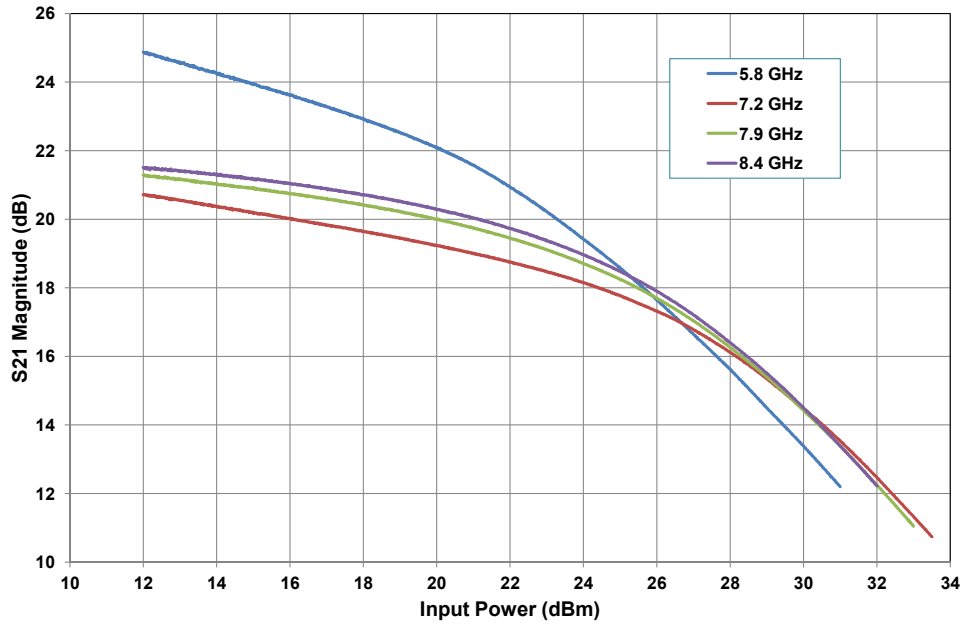
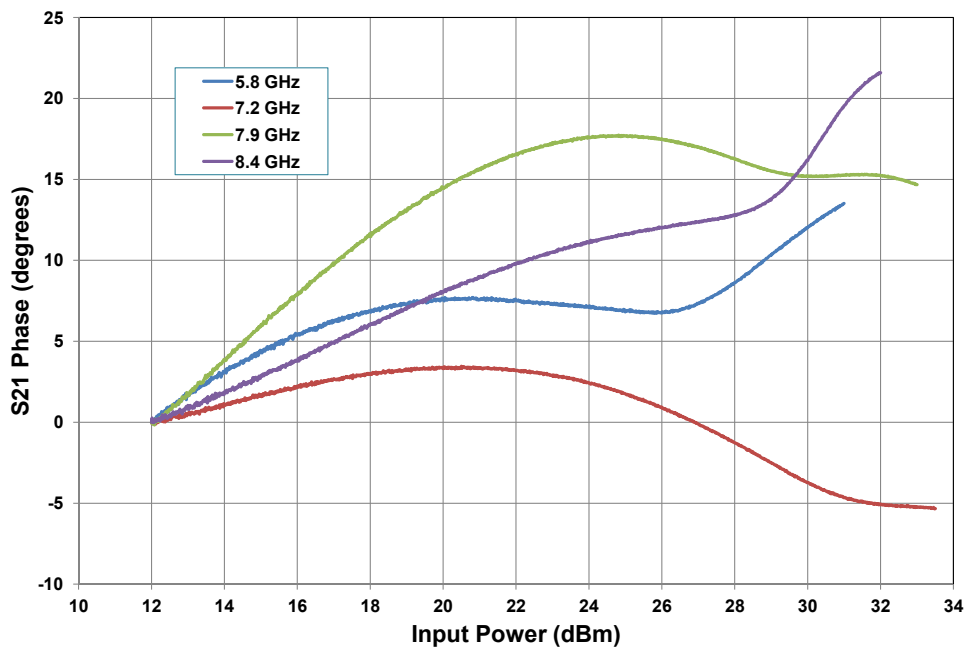

Figure 16. CMPA5585025F -Normalized AM-PM
 $V_{DS} = 28\text{ V}, I_{DS} = 285\text{ mA}$



Typical Performance of the CMPA5585025F

Figure 17. CMPA5585025F EVM vs Average Output Power
 $V_{DS} = 28\text{ V}, I_{DS} = 285\text{ mA}, 256\text{ QAM}$

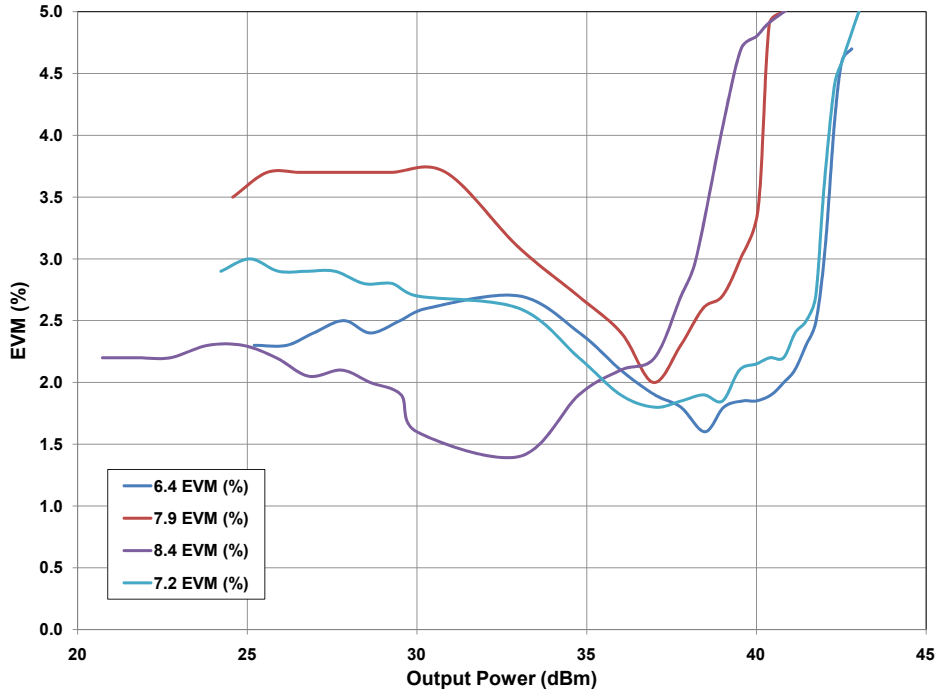
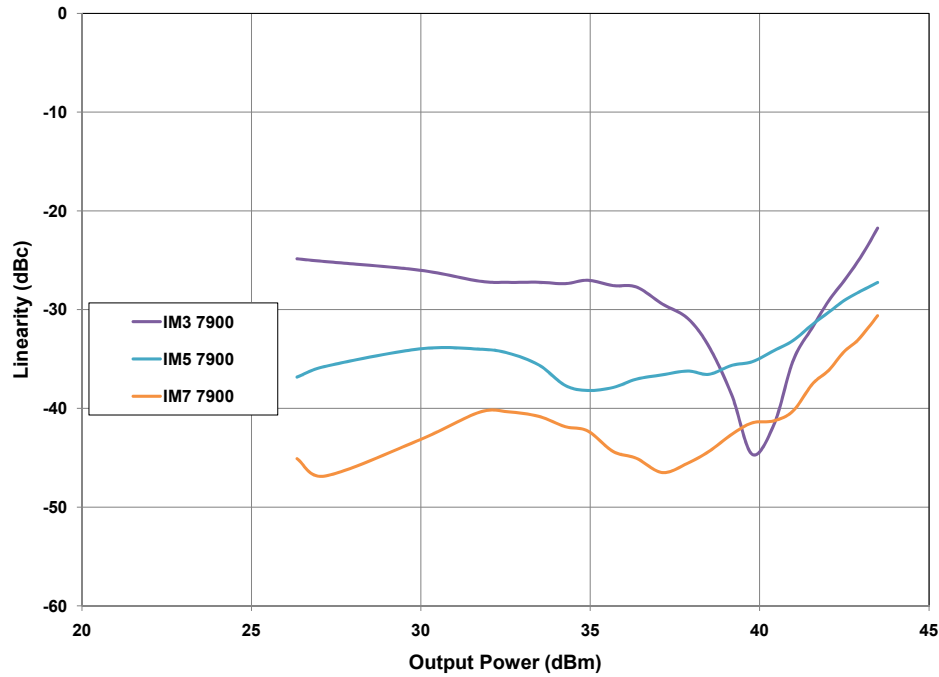
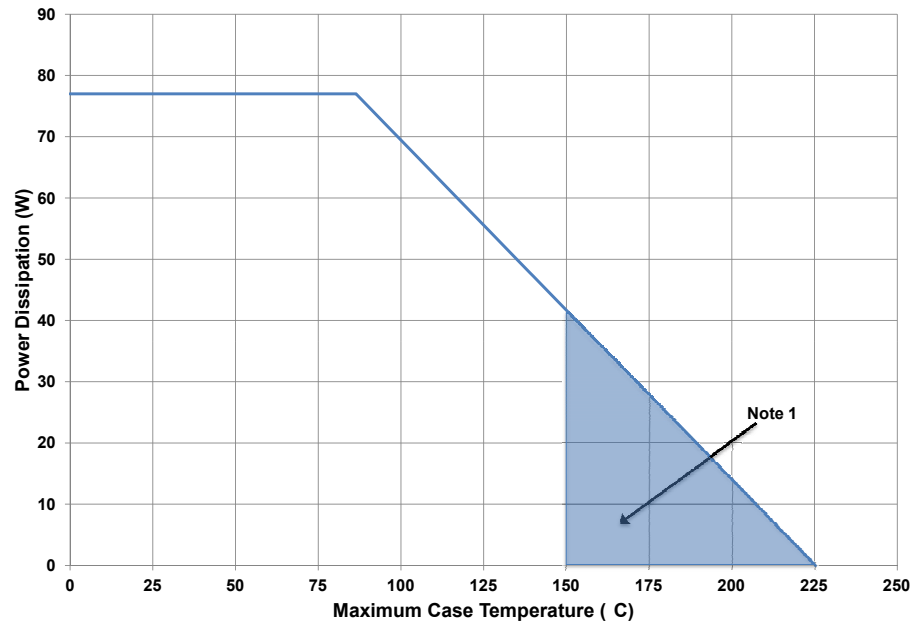

Figure 18. CMPA5585025F Linearity vs Average Output Power
 $V_{DS} = 28\text{ V}, I_{DS} = 285\text{ mA}, \text{IM3, IM5, IM7, } 5\text{ MHz spacing}$



CMPA5585025F Power Dissipation De-rating Curve



Note 1. Area exceeds Maximum Case Operating Temperature (See Page 2).

CMPA5585025F-AMP Demonstration Amplifier Circuit Bill of Materials

| Designator | Description | Qty |
|--------------------------|--|-----|
| C1, C3, C7, C8, C10, C13 | CAP, 1.0 uF, +/-10%, 1210, 100V, X7R | 6 |
| C2, C4, C5, C6, C9, C12 | CAP, 33000 pF, 0805, 100V, X7R | 6 |
| C11, C14 | CAP ELECT 3.3UF 80V FK SMD | 2 |
| R1, R2 | RES 0.0 OHM 1/16W 0402 SMD | 2 |
| J1, J2 | CONN, SMA, PANEL MOUNT JACK, FLANGE, 4-HOLE, BLUNT POST, 20MIL | 2 |
| J3 | CONNECTOR, HEADER, RT>PLZ .1CEN LK 9POS | 1 |
| - | PCB, TACONIC, RF-35P-0200-CL1/CL1 | 1 |
| Q1 | CMQA5585025F | 1 |

CMQA5585025F-AMP Demonstration Amplifier Circuit

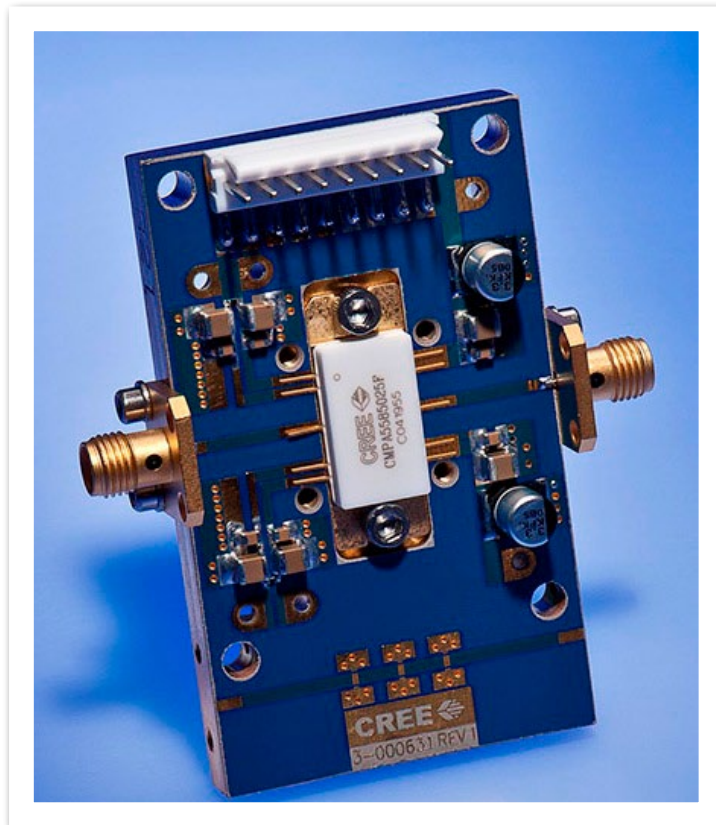

CMPA5585025F-AMP Demonstration Amplifier Circuit

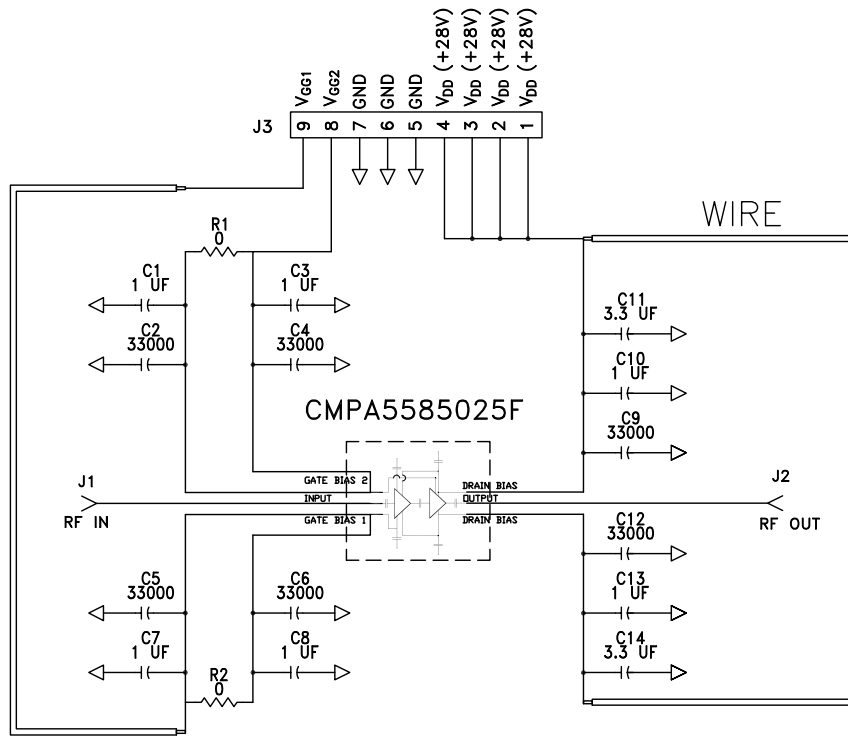

CMPA5585025F-AMP Demonstration Amplifier Circuit Outline

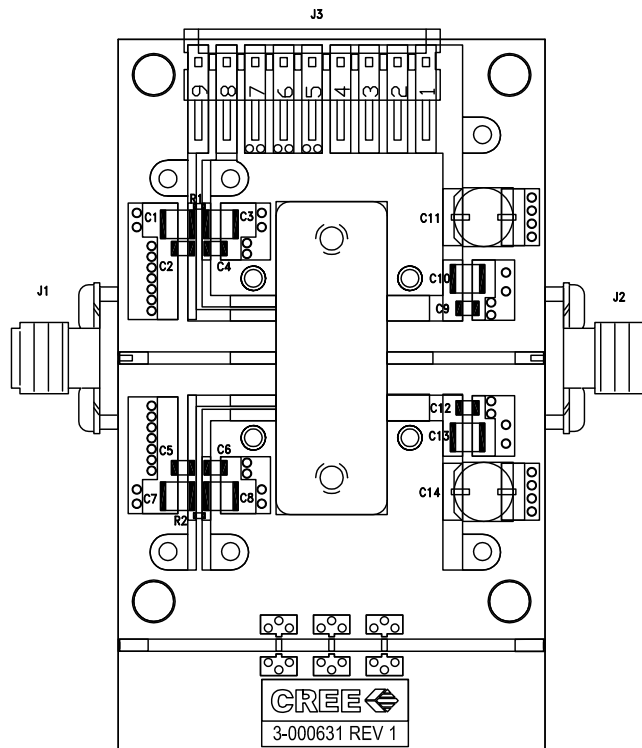

CMPA5585025F-AMP Demonstration Amplifier Circuit

To configure the CPM5585025F test fixture to enable independent V_{G1} / V_{G2} control of the device, a cut must be made to the microstrip line just above the R1 resistor as shown. Pin 9 will then supply V_{G1} and Pin 8 will supply V_{G2} .

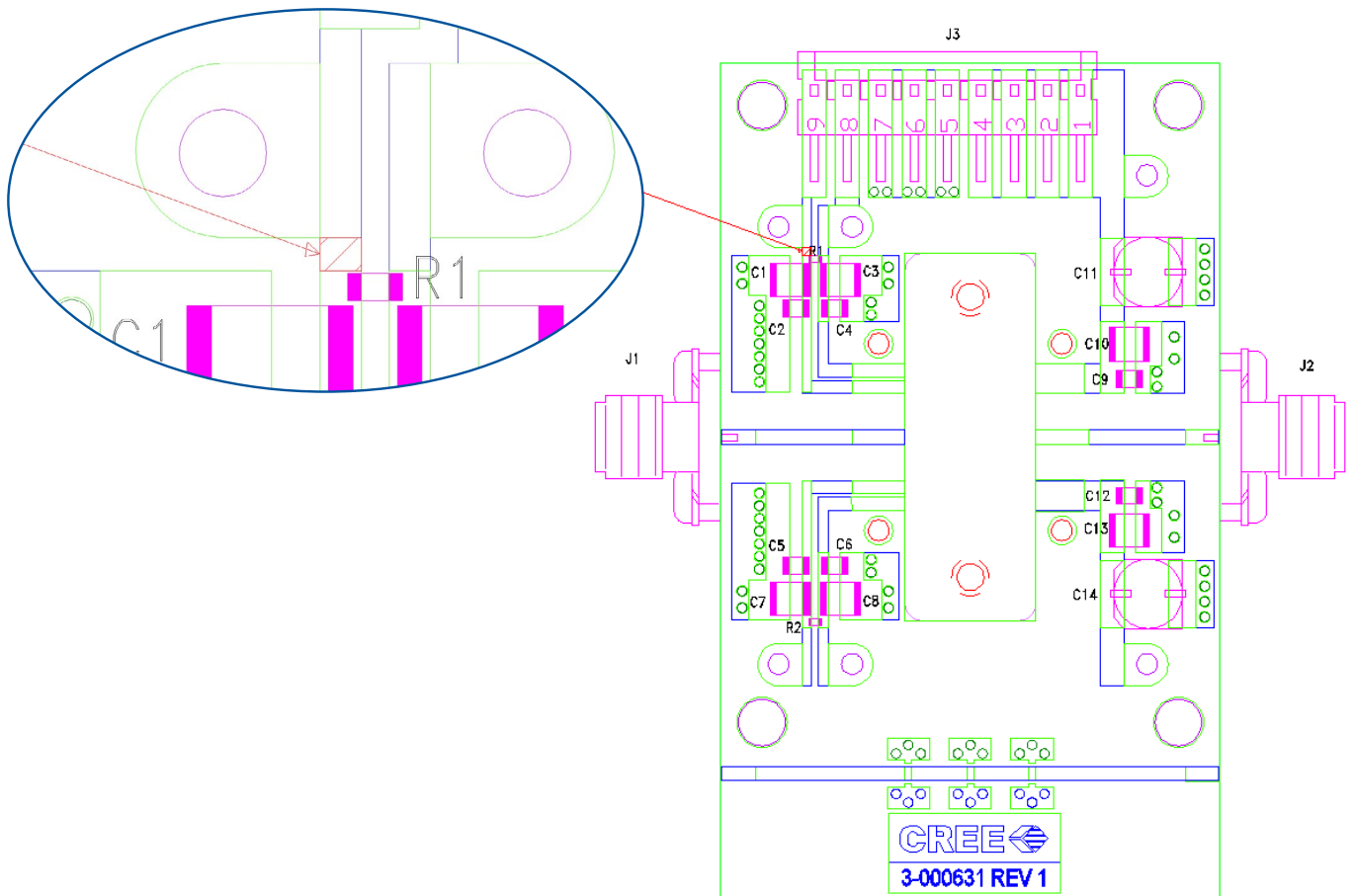

Product Dimensions CMPA5585025F (Package Type – 440208)

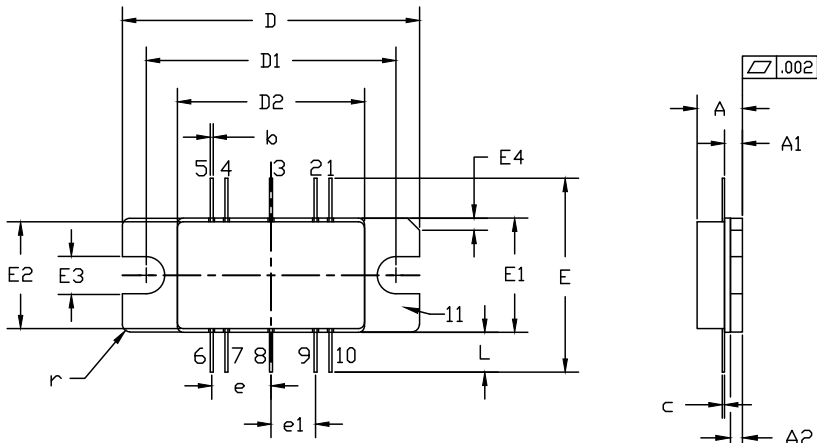

PIN 1: GATE BIAS 6: DRAIN BIAS
 2: GATE BIAS 7: DRAIN BIAS
 3: RF IN 8: RF OUT
 4: GATE BIAS 9: DRAIN BIAS
 5: GATE BIAS 10: DRAIN BIAS
 11: SOURCE

NOTES:

1. DIMENSIONING AND TOLERANCING PER ANSI Y14.5M - 1994.
2. CONTROLLING DIMENSION: INCH.
3. ADHESIVE FROM LID MAY EXTEND A MAXIMUM OF 0.020" BEYOND EDGE OF LID.
4. LID MAY BE MISALIGNED TO THE BODY OF PACKAGE BY A MAXIMUM OF 0.008" IN ANY DIRECTION.

| DIM | INCHES | | MILLIMETERS | | NOTES |
|-----|-----------|-------|-------------|-------|-------------|
| | MIN | MAX | MIN | MAX | |
| A | 0.148 | 0.168 | 3.76 | 4.27 | |
| A1 | 0.055 | 0.065 | 1.40 | 1.65 | |
| A2 | 0.035 | 0.045 | 0.89 | 1.14 | |
| b | 0.01 TYP | | 0.254 TYP | | 10x |
| c | 0.007 | 0.009 | 0.18 | 0.23 | |
| D | 0.995 | 1.005 | 25.27 | 25.53 | |
| D1 | 0.835 | 0.845 | 21.21 | 21.46 | |
| D2 | 0.623 | 0.637 | 15.82 | 16.18 | |
| E | 0.653 TYP | | 16.59 TYP | | |
| E1 | 0.380 | 0.390 | 9.65 | 9.91 | |
| E2 | 0.355 | 0.365 | 9.02 | 9.27 | |
| E3 | 0.120 | 0.130 | 3.05 | 3.30 | |
| E4 | 0.035 | 0.045 | 0.89 | 1.14 | 45° CHAMFER |
| e | 0.200 TYP | | 5.08 TYP | | 4x |
| e1 | 0.150 TYP | | 3.81 TYP | | 4x |
| L | 0.115 | 0.155 | 2.92 | 3.94 | 10x |
| r | 0.025 TYP | | .635 TYP | | 3x |

| Pin Number | Qty |
|------------|-----------------------|
| 1 | Gate Bias for Stage 2 |
| 2 | Gate Bias for Stage 2 |
| 3 | RF In |
| 4 | Gate Bias for Stage 1 |
| 5 | Gate Bias for Stage 1 |
| 6 | Drain Bias |
| 7 | Drain Bias |
| 8 | RF Out |
| 9 | Drain Bias |
| 10 | Drain Bias |
| 11 | Source |

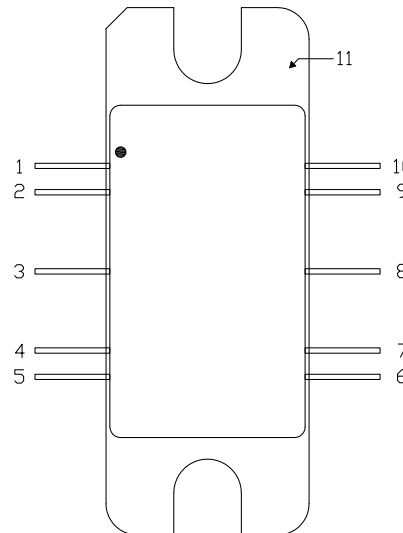

Part Number System

CMPA5585025F

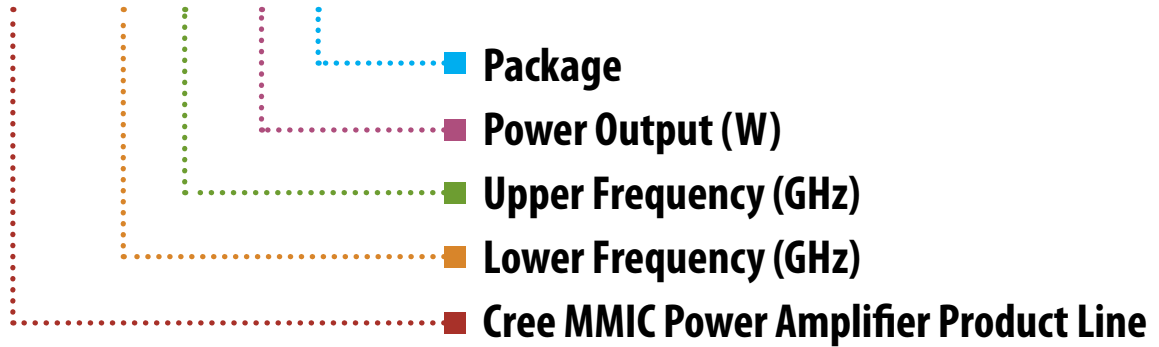

| Parameter | Value | Units |
|------------------------------|--------|-------|
| Lower Frequency | 5.5 | GHz |
| Upper Frequency ¹ | 8.5 | GHz |
| Power Output | 25 | W |
| Package | Flange | - |

Table 1.

Note¹: Alpha characters used in frequency code indicate a value greater than 9.9 GHz. See Table 2 for value.

| Character Code | Code Value |
|----------------|--------------------------------|
| A | 0 |
| B | 1 |
| C | 2 |
| D | 3 |
| E | 4 |
| F | 5 |
| G | 6 |
| H | 7 |
| J | 8 |
| K | 9 |
| Examples: | 1A = 10.0 GHz 2H = 27.0 GHz |

Table 2.

Product Ordering Information

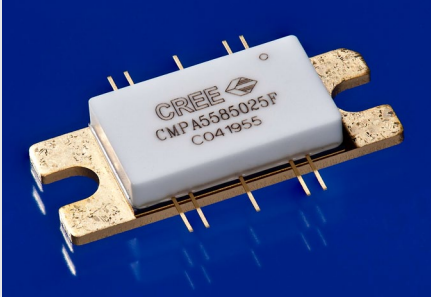
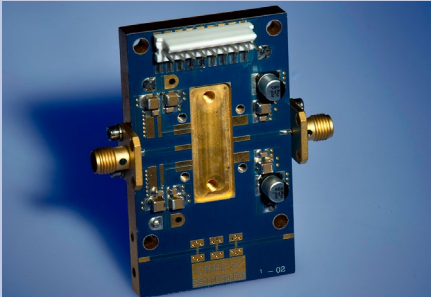
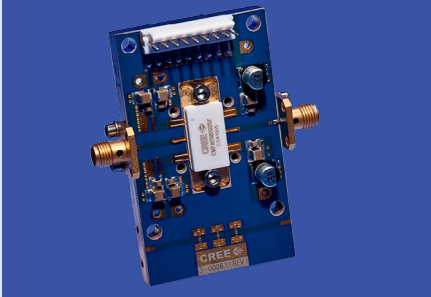
| Order Number | Description | Unit of Measure | Image |
|------------------|------------------------------------|-----------------|---|
| CMPA5585025F | GaN MMIC | Each |  |
| CMPA5585025F-TB | Test board without GaN MMIC | Each |  |
| CMPA5585025F-AMP | Test board with GaN MMIC installed | Each |  |



Disclaimer

Specifications are subject to change without notice. Cree, Inc. believes the information contained within this data sheet to be accurate and reliable. However, no responsibility is assumed by Cree for its use or for any infringement of patents or other rights of third parties which may result from its use. No license is granted by implication or otherwise under any patent or patent rights of Cree. Cree makes no warranty, representation or guarantee regarding the suitability of its products for any particular purpose. "Typical" parameters are the average values expected by Cree in large quantities and are provided for information purposes only. These values can and do vary in different applications, and actual performance can vary over time. All operating parameters should be validated by customer's technical experts for each application. Cree products are not designed, intended, or authorized for use as components in applications intended for surgical implant into the body or to support or sustain life, in applications in which the failure of the Cree product could result in personal injury or death, or in applications for the planning, construction, maintenance or direct operation of a nuclear facility. CREE and the CREE logo are registered trademarks of Cree, Inc.

For more information, please contact:

Cree, Inc.
4600 Silicon Drive
Durham, North Carolina, USA 27703
www.cree.com/RF

Sarah Miller
Marketing
Cree, RF Components
1.919.407.5302

Ryan Baker
Marketing & Sales
Cree, RF Components
1.919.407.7816

Tom Dekker
Sales Director
Cree, RF Components
1.919.407.5639