

## X Band Driver Amplifier

### GaAs Monolithic Microwave IC

#### Description

The CHA5012 chip is a monolithic two-stage medium power amplifier designed for X band applications.

This device is manufactured using a GaInP HBT process, including via holes through the substrate and air bridges. A nitride layer protects the transistors and the passive components. Special heat removal techniques are implemented to guarantee high reliability.

To simplify the assembly process:

- the backside of the chip is both RF and DC grounded
- bond pads and back side are gold plated for compatibility with eutectic die attach method and thermosonic or thermocompression bonding process.

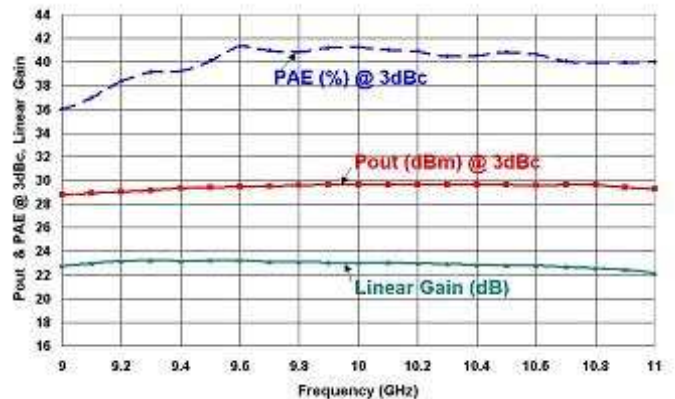
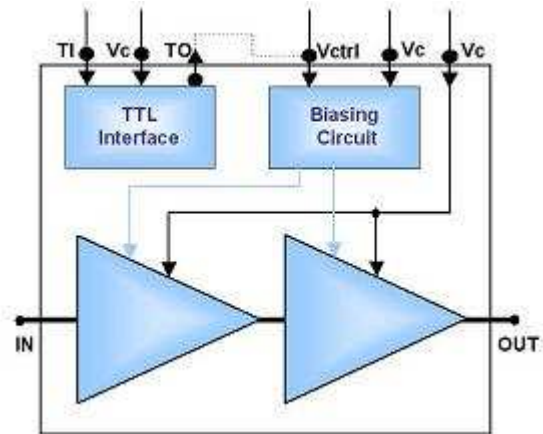

*Pout & PAE @ 3dB gain compression and Linear Gain (Temperature 25°C)*

#### Main Features

- Frequency band : 9.2-10.8 GHz
- Pout @3dB Gain compression : 29.5 dBm
- P.A.E @3dB Gain Compression : 40 %
- Two biasing modes:
  - Digital control thanks to TTL interface
  - Analog control thanks to biasing circuit
- Chip size: 2.87 x 1.47 x 0.1 mm<sup>3</sup>

#### Main Characteristics

Tamb = +25°C, Vc = +7.5V (Pulse 100µs 20%)

Symbol	Parameter	Min	Typ	Max	Unit
Fop	Operating frequency range	9.2		10.8	GHz
G	Small signal gain	21	23		dB
P3dB	Output power at 3dB compression		29.5		dBm
Icq	Power supply quiescent current		200		mA

ESD Protections : Electrostatic discharge sensitive device observe handling precautions

## Electrical Characteristics

Vc= +7.5V (Pulse 100µs 20%)

Symbol	Parameter	Min	Typ	Max	Unit
Fop	Operating frequency range	9.2		10.8	GHz
G	Small signal gain at 25°C	21	22.5		dB
ΔG	Small signal gain flatness at 25°C		±0.5		dB
ΔG_T	Linear gain variation vs temperature		-0.025		dB/°C
Pin	Input Power (1)			17	dBm
P1dB	Output power at 1dB gain compression at 25°C		28		dBm
P3dB	Output power at 3dB gain compression at 25°C	27.5	29.5		dBm
	Output power at 3dB gain compression at 80°C	27	29		
PAE_3dBc	PAE at 3dB gain compression at 25°C		40		%
	PAE at 3dB gain compression at 80°C		37		
dBS11	Input Return Loss		-12	-10	dB
dBS22	Output Return Loss		-10	-7	dB
Vc	Power supply voltage		7.5		V
Icq	Power supply quiescent current (2)		200		mA
Ic_3dBc	Consumption under 3dB compression		290		mA
Vctrl	Collector current control voltage		5		V
Ictrl	Biasing circuit consumption		5		mA
I_Tl	TTL input consumption		1		mA
TI_Low	TTL input voltage low level		0	0.4	V
TI_High	TTL input voltage high level (2)	2.5	5		mA

(1) Output Load 50Ω

(2) For Vc=7.5V, TTL interface settles Icq to 200 mA when TI=TI\_High . If needed, Icq can be tuned thanks to Vctrl if the analog biasing circuit is used

## Absolute Maximum Ratings (3)

Tamb = 25°C

Symbol	Parameter	Values	Unit
Top	Operating temperature range	-40 to +80	°C
Vc	Power supply voltage (4)	10	V
Icq	Power supply quiescent current	320	mA
Ic_sat	Power supply current in saturation	350	mA
Vct	Collector current control voltage	6.5	V
Tj	Maximum Junction temperature	175	°C
Tstg	Storage temperature range	-55 to +125	°C

(3) Operation of this device above anyone of these parameters may cause permanent damage.

(4) Without RF input power

Typical measurement characteristics

Measurement conditions :

Vc=7.5V

TTL interface used for biasing. TI\_High=5V and TI\_Low=0V (Ic Quiescent=200mA)

Pulse width=100µs, Duty cycle= 20%

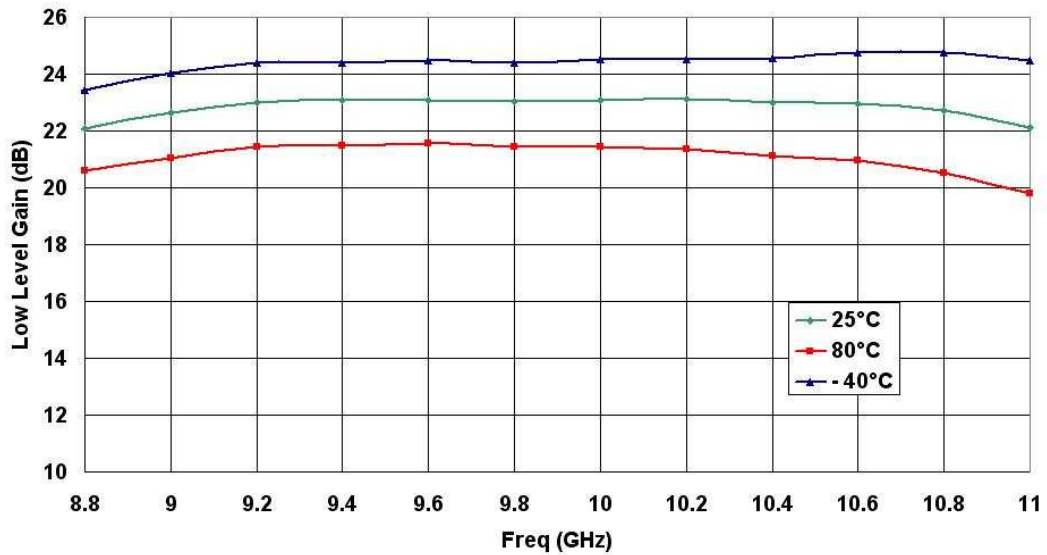

Linear gain versus frequency and temperature

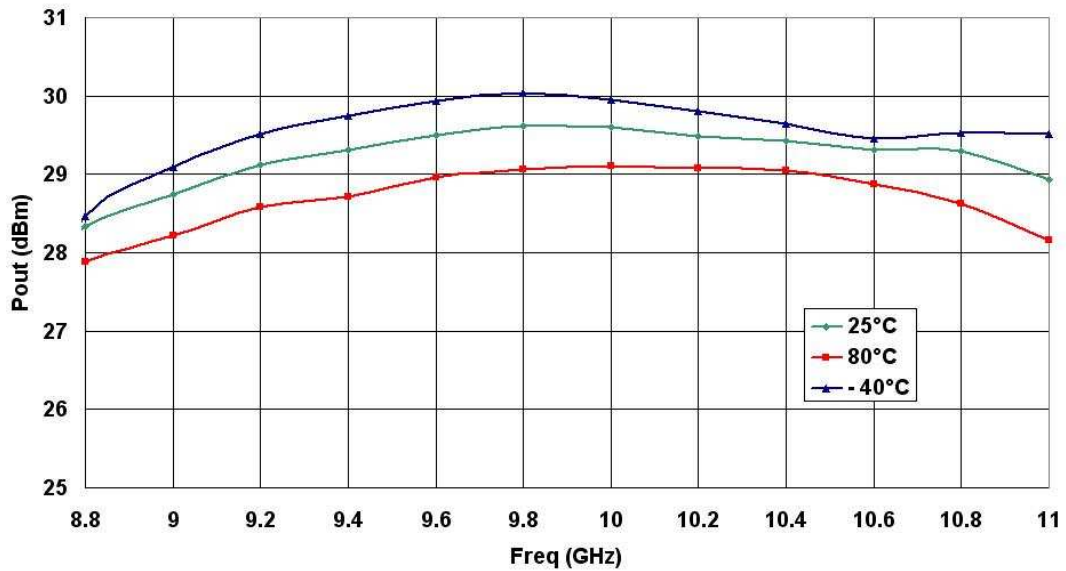

Output power @3dB gain compression versus frequency and temperature

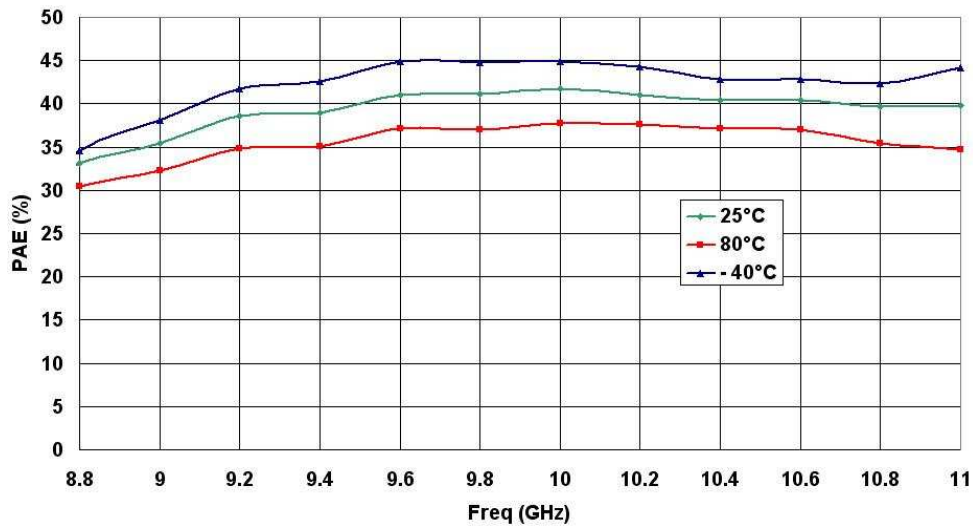

**Power added efficiency @3dB gain compression versus frequency and temperature**

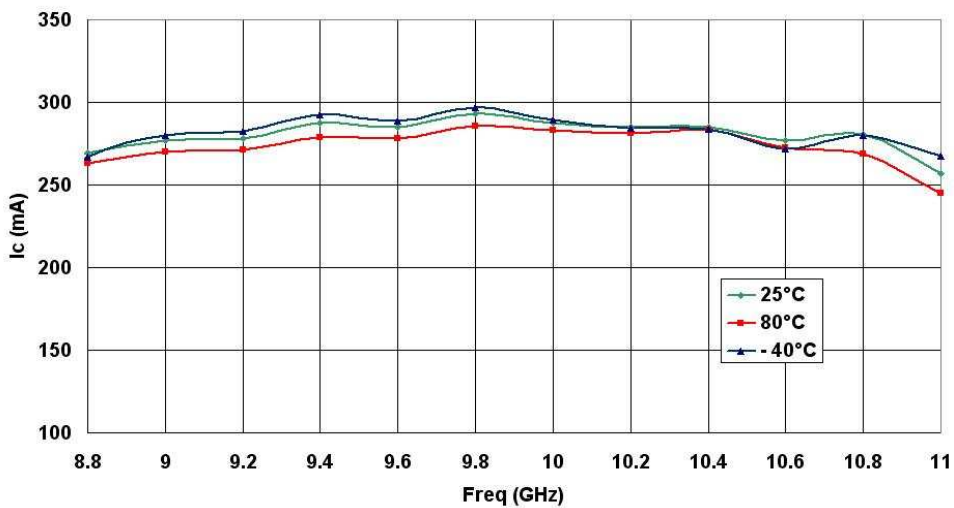

**Collector current @3dB gain compression versus frequency and temperature**

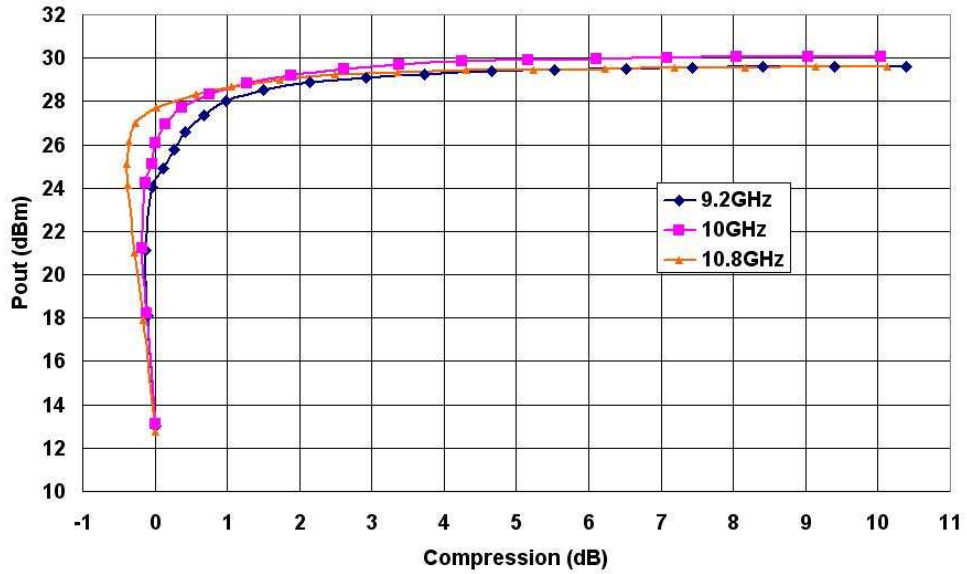

Output power versus gain compression and frequency (Temp.=25°C)

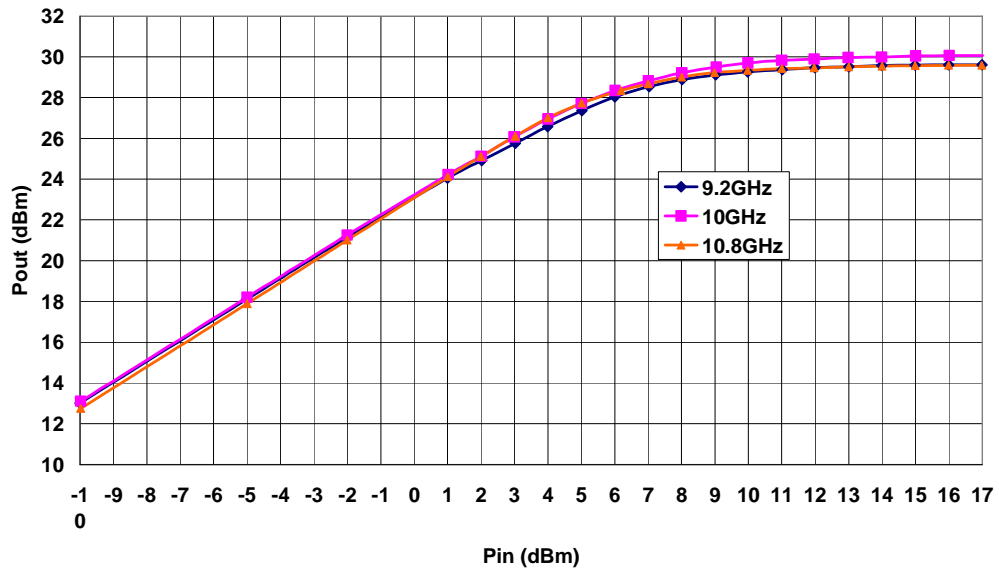

Output power versus Pin and frequency (Temp.=25°C)

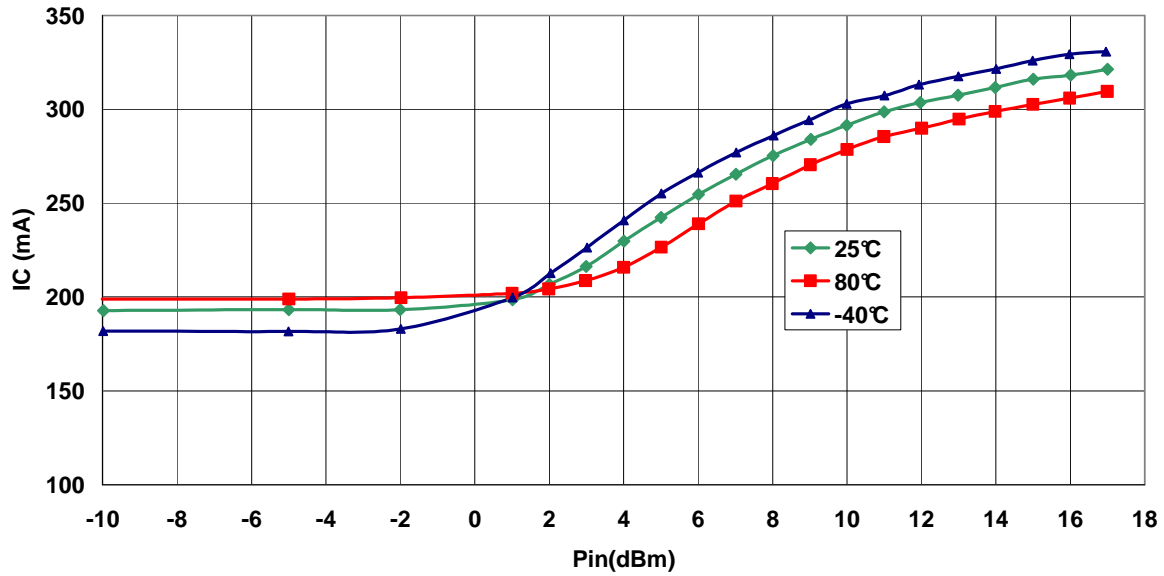

**Collector current versus input power and temperature @10GHz**

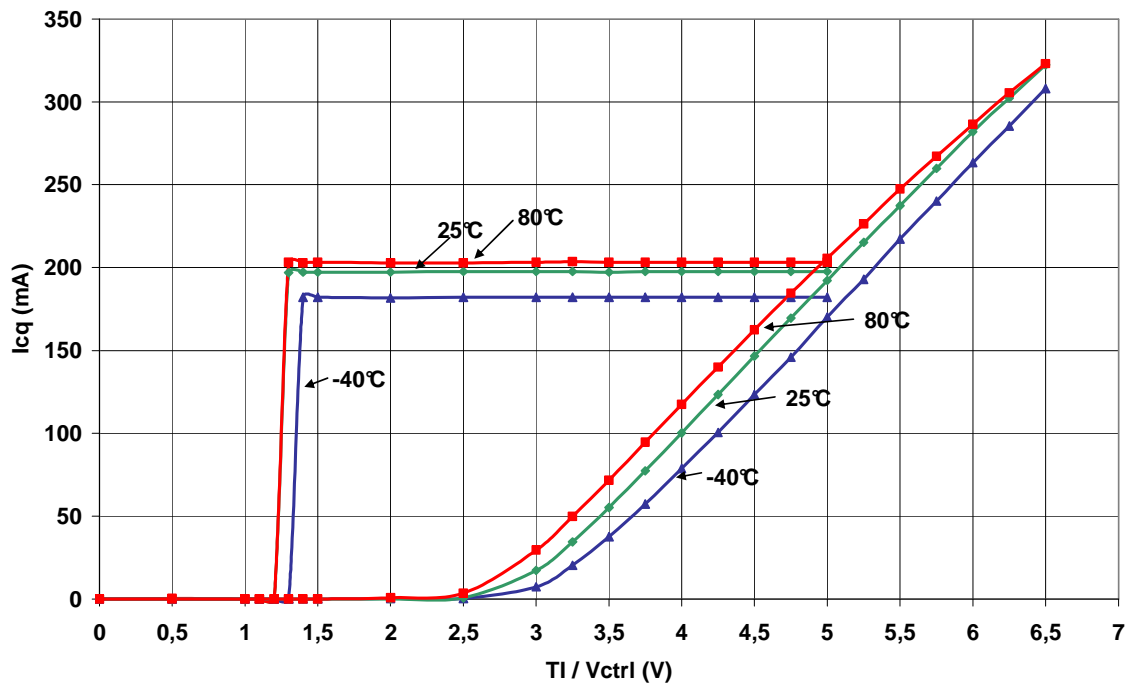

**Collector quiescent current versus TI, Vctrl and temperature**

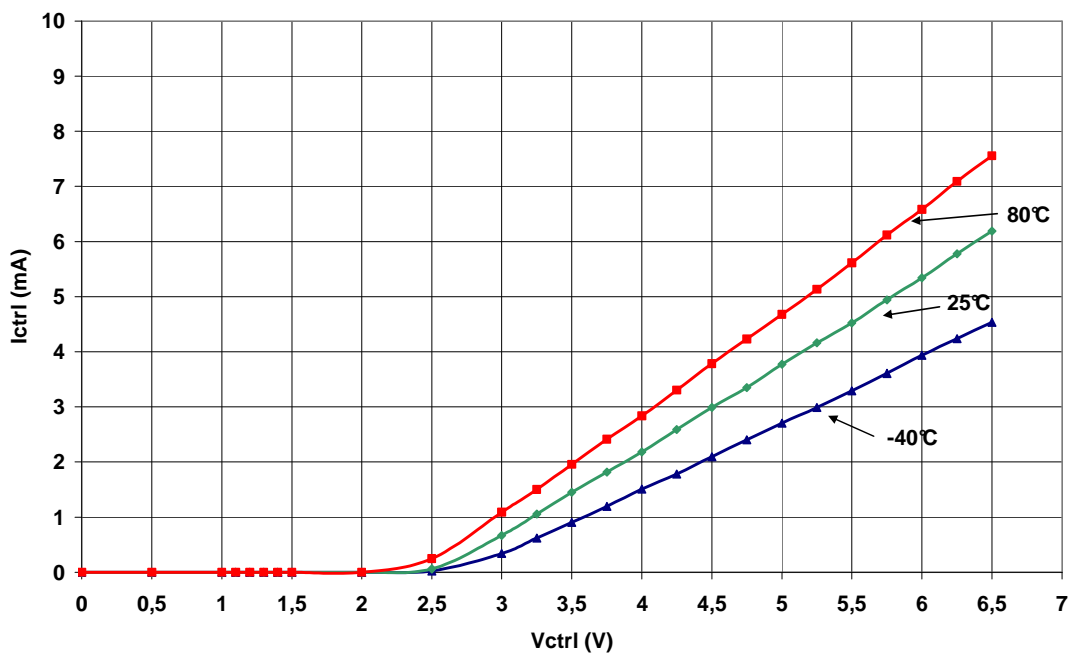

Control current versus  $V_{ctrl}$  and temperature

## Chip Mechanical Data and Pin references

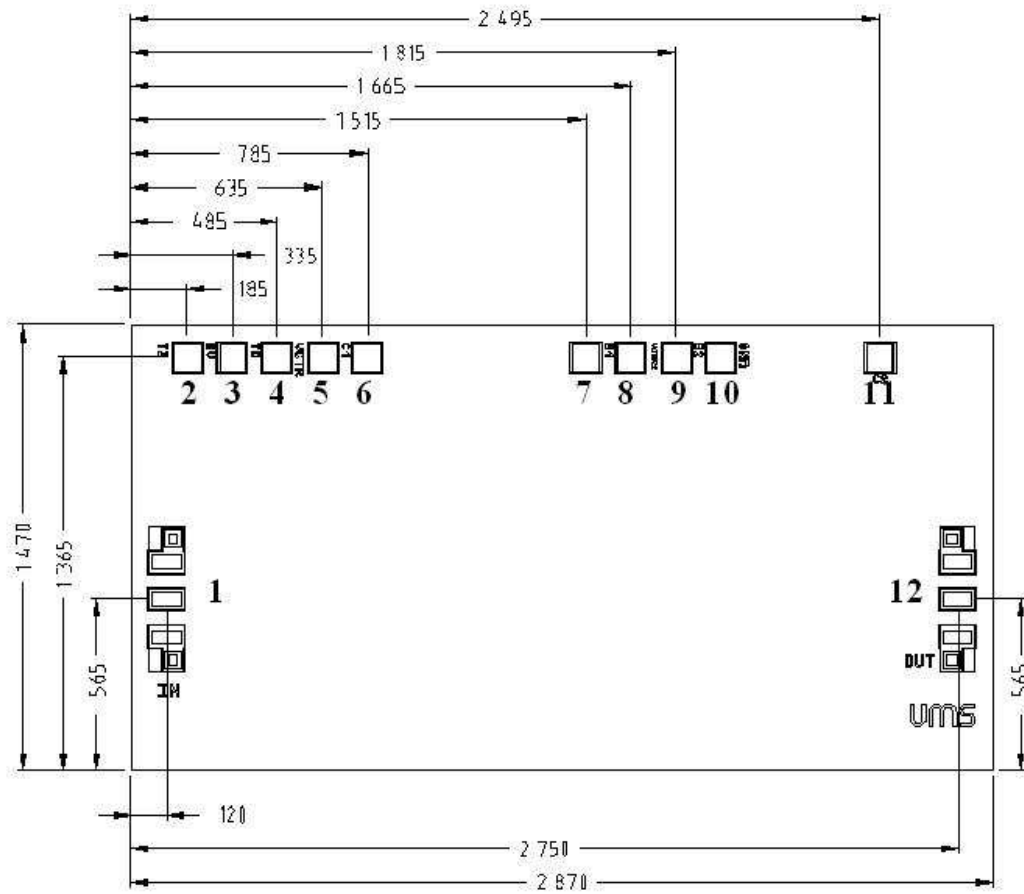

UNITS :  $\mu\text{m}$   
 Tol :  $\pm 35\mu\text{m}$

Chip thickness =  $100 \pm 10 \mu\text{m}$   
 RF pads (1, 12) =  $118 \times 68 \mu\text{m}^2$   
 DC pads (2, 3, 4, 5, 9, 6, 7, 8, 9, 10, 11) =  $96 \times 96 \mu\text{m}^2$

Pin number	Pin name	Description
1	IN	Input RF port
7, 9		NC
5, 8	Vctrl	Collector current control voltage
2	TI	TTL input
4	TO	TTL output
10	GND	Ground (NC)
3, 6, 11	Vc	Power supply voltage
12	OUT	Output RF port



**Bonding recommendations**

Port	Connection
IN (1)	Inductance ( $L_{bonding}$ ) = 0.3nH 400 $\mu$ m length with wire diameter of 25 $\mu$ m
OUT (12)	Inductance ( $L_{bonding}$ ) = 0.3nH 400 $\mu$ m length with wire diameter of 25 $\mu$ m

**Assembly recommendations in test fixture using TTL interface**

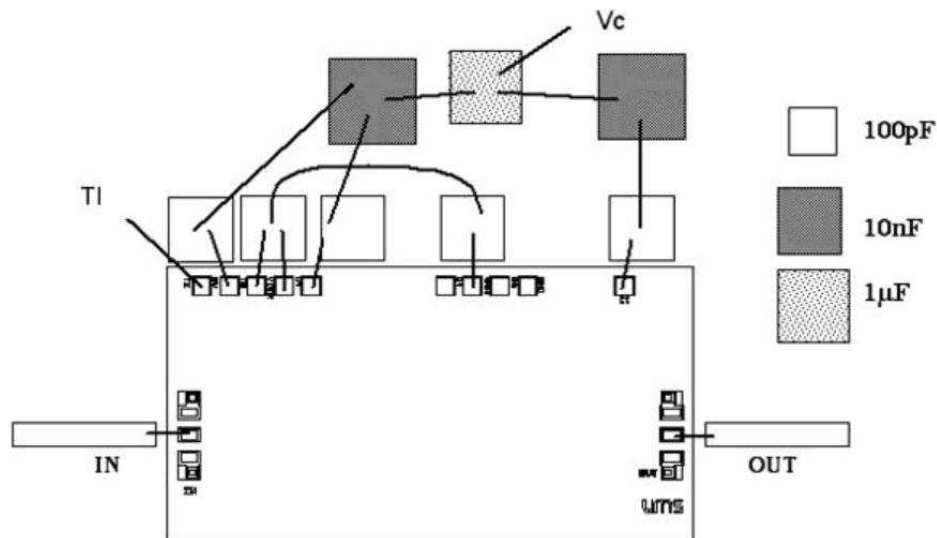

Note: when the TTL interface is used for biasing, the pin TO (pin number 4) must be connected to the pins Vctrl (pins number 5 and 8).

**Assembly recommendations in test fixture using analog biasing circuits**

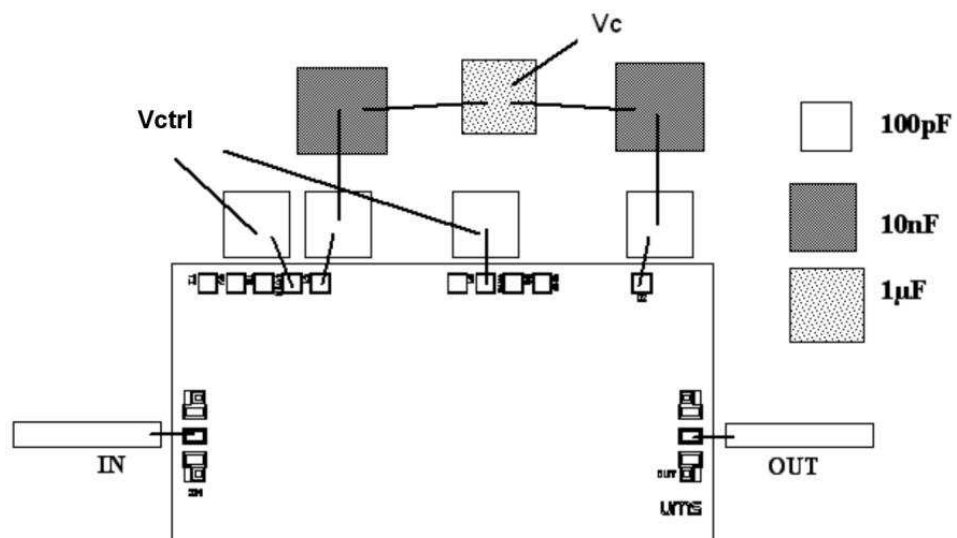

## Recommended ESD management

Refer to the application note AN0020 available at <http://www.ums-gaas.com> for ESD sensitivity and handling recommendations for the UMS products.

## Ordering Information

Chip form : CHA5012-99F/00

Information furnished is believed to be accurate and reliable. However **United Monolithic Semiconductors S.A.S.** assumes no responsibility for the consequences of use of such information nor for any infringement of patents or other rights of third parties which may result from its use. No license is granted by implication or otherwise under any patent or patent rights of **United Monolithic Semiconductors S.A.S.** Specifications mentioned in this publication are subject to change without notice. This publication supersedes and replaces all information previously supplied. **United Monolithic Semiconductors S.A.S.** products are not authorised for use as critical components in life support devices or systems without express written approval from **United Monolithic Semiconductors S.A.S.**