

Product will be discontinued.

Product Discontinuation Notice Issued on 24 Nov 2014

SpiceLED[™]

Like spice, its diminutive size is a stark contrast to its standout performance in terms of brightness, durability and reliability. Despite being the smallest in size yet the SpiceLED[™] packs a powerful performance and is a highly reliable design device. Its versatility enables its application in automotive appliances, key-pad illumination, hand-held devices such as PDAs, notebooks, compact back-lighting applications, consumer appliances, office equipment, audio and video equipment.

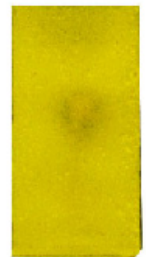

Features:

- > High brightness surface mount LED.
- > Super wide viewing angle of 160°.
- > Equivalent to 0603 package outline. Copper lead-frame construction.
- > Qualified according to JEDEC moisture sensitivity Level 2.
- > Compatible to IR reflow soldering.
- > Environmental friendly; RoHS compliance.

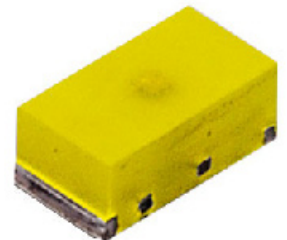

Applications:

- > Signage: full colour display video notice board, signage, special effect lighting.



Optical Characteristics at Tj=25°C

Part Ordering Number	Color	Viewing Angle°	Luminous Intensity @ IF = 20mA IV (mcd)		
			Min.	Typ.	Max.
● SSF-HLG-UV1-1	Warm White	160	450.00	600.0	900.00

● Not for new design

NOTE

1. All part number above comes in a quantity of 3000 units per reel.
2. Other luminous intensity groups are also available upon request
3. Luminous intensity is measured with an accuracy of ± 11%.
4. Wavelength binning is carried for all units as per the wavelength-binning table. Only one wavelength group is allowed for each reel.

Part Number	Vf @ If = 20mA			Vr @ Ir = 10uA
	Min. (V)	Typ. (V)	Max. (V)	Min. (V)
SSF-HLG	2.9	3.2	3.6	5

Forward voltage, Vf is measured with an accuracy of ± 0.1 V.

Absolute Maximum Ratings

	Maximum Value	Unit
DC forward current	30	mA
Peak pulse current; (tp ≤ 10µs, Duty cycle = 0.1)	100	mA
Reverse voltage; Ir _{max} = 10µA	5	V
ESD threshold (HBM)	2000	V
LED junction temperature	110	°C
Operating temperature	-40 ... +100	°C
Storage temperature	-40 ... +100	°C
Power dissipation (at room temperature)	80	mW

SSF-HLG, Warm White Color Grouping

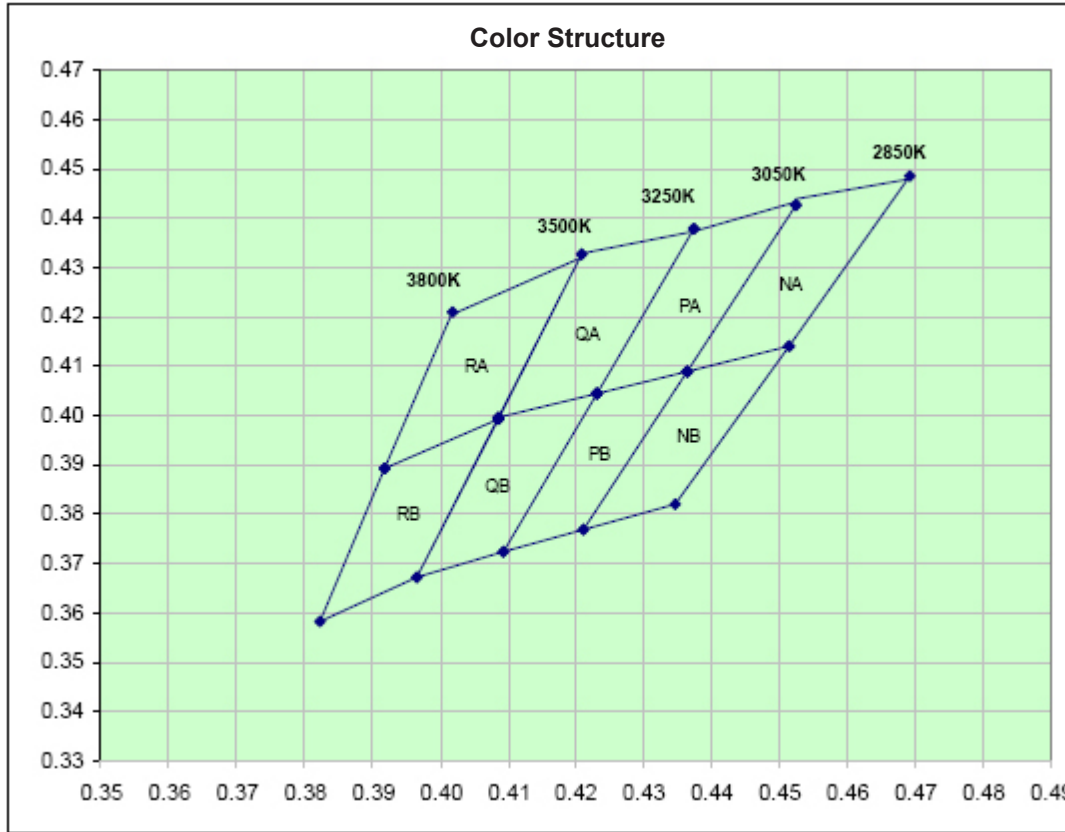

Chromaticity coordinate groups are measured with an accuracy of ± 0.01 .

Bin		1	2	3	4
RA	Cx	0.402	0.392	0.409	0.421
	Cy	0.421	0.389	0.399	0.433
RB	Cx	0.392	0.382	0.397	0.409
	Cy	0.389	0.358	0.367	0.399
QA	Cx	0.421	0.409	0.423	0.437
	Cy	0.433	0.400	0.405	0.438
QB	Cx	0.409	0.397	0.409	0.423
	Cy	0.400	0.367	0.372	0.405
PA	Cx	0.437	0.423	0.436	0.452
	Cy	0.438	0.405	0.409	0.443
PB	Cx	0.423	0.409	0.421	0.436
	Cy	0.405	0.372	0.377	0.409
NA	Cx	0.452	0.436	0.451	0.469
	Cy	0.443	0.409	0.414	0.448
NB	Cx	0.436	0.421	0.435	0.451
	Cy	0.409	0.377	0.382	0.414

InGaN wavelength is very sensitive to drive current. Operating at lower current is not recommended and may yield unpredictable performance. Current pulsing should be used for dimming purposes.

Luminous Intensity Group at Tj=25°C

Brightness Group	Luminous Intensity IV (mcd)
U1	450.0...560.0
U2	560.0...715.0
V1	715.0...900.0

Luminous intensity is measured with an accuracy of ± 11%.

Vf Binning (Optional)

Vf Bin @ 20mA	Forward Voltage (V)
01	2.90 ... 3.00
02	3.00 ... 3.10
03	3.10 ... 3.20
04	3.20 ... 3.30
05	3.30 ... 3.40
06	3.40 ... 3.50
07	3.50 ... 3.60

Forward voltage, Vf is measured with an accuracy of ± 0.1 V.
 Please consult sales and marketing for special part number to incorporate Vf binning.

Relative Luminous Intensity Vs Forward Current

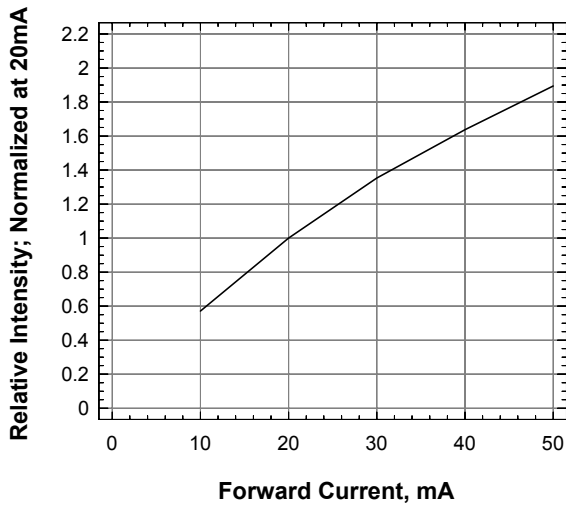

Forward Current Vs Forward Voltage

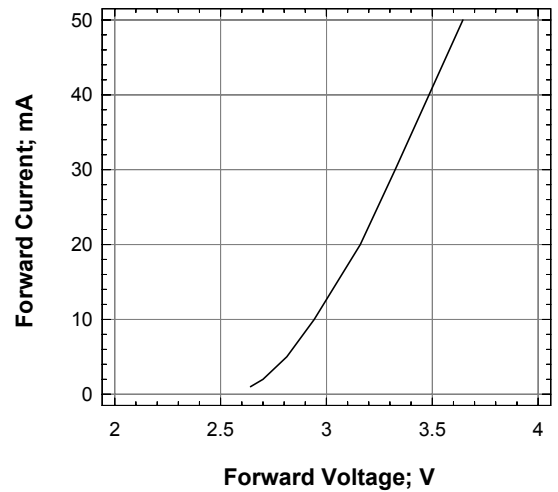

Forward Current Vs Ambient Temperature

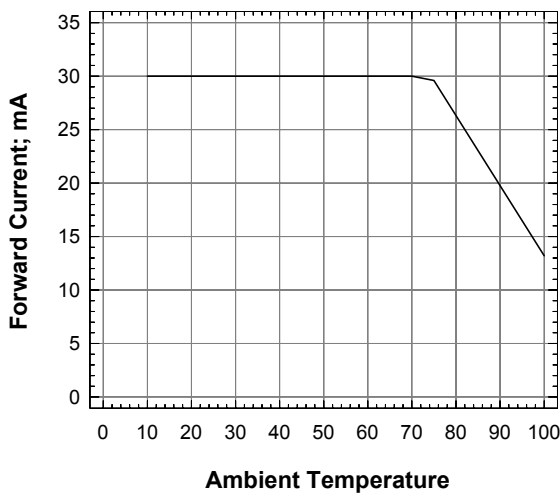

Relative Intensity Vs Wavelength

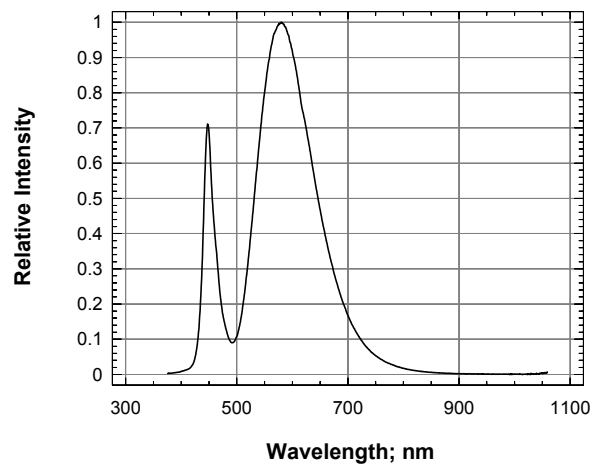

Radiation Pattern

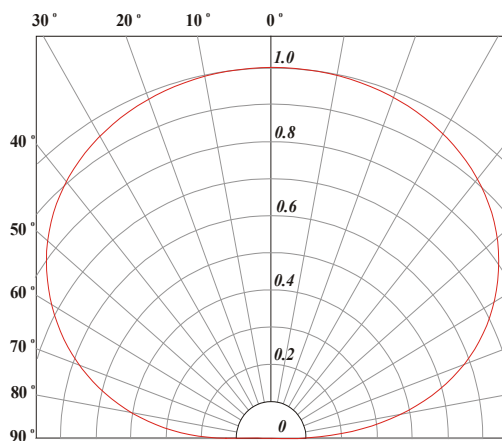

SpiceLED™ • InGaN Warm White S-Spice : SSF-HLG Package

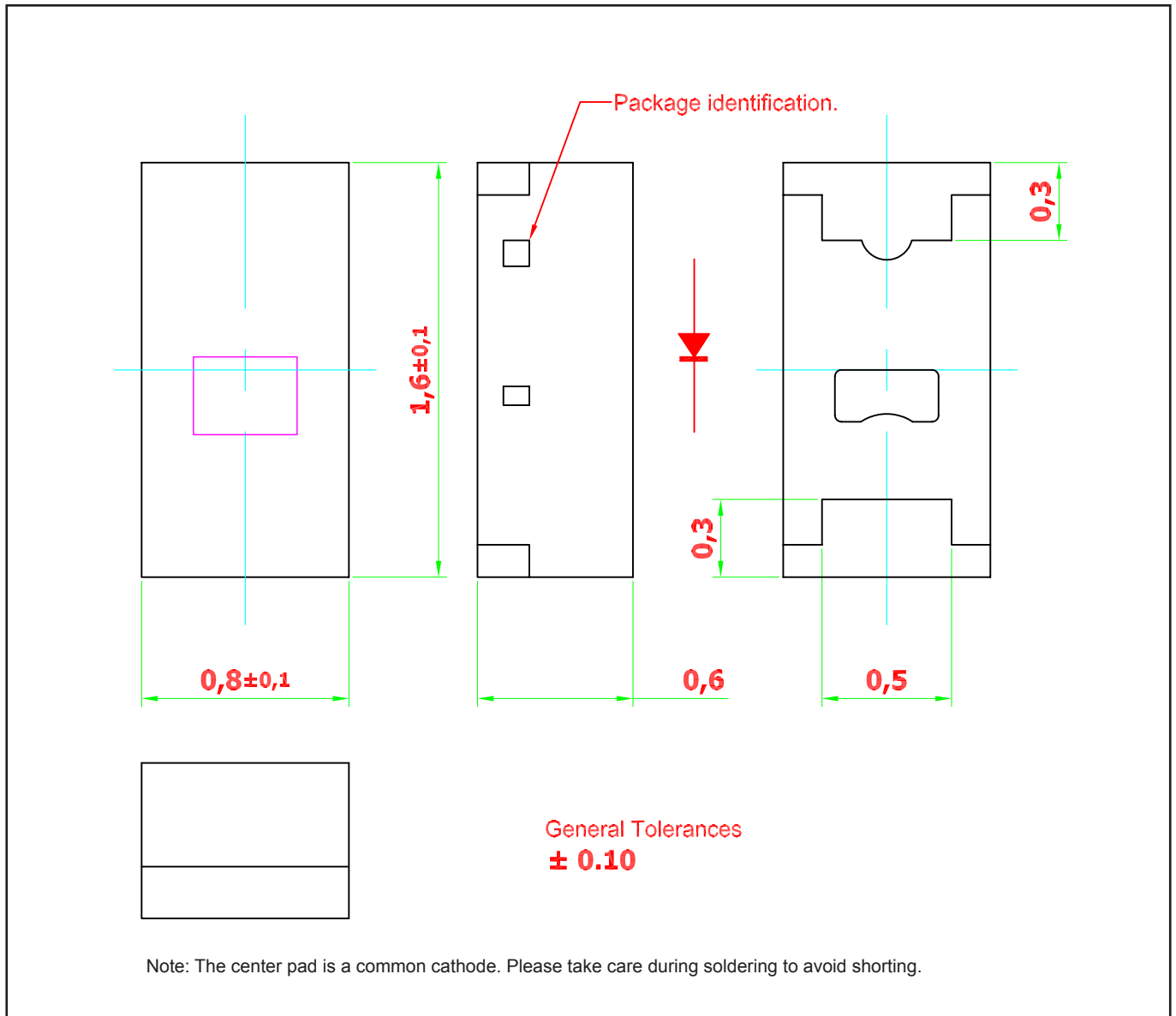

Material

Material	
Lead-frame	Cu Alloy With NiPdAu Plating
Package	High Temperature Resistant Epoxy Resin

Note: product is Pb free

Recommended Solder Pad

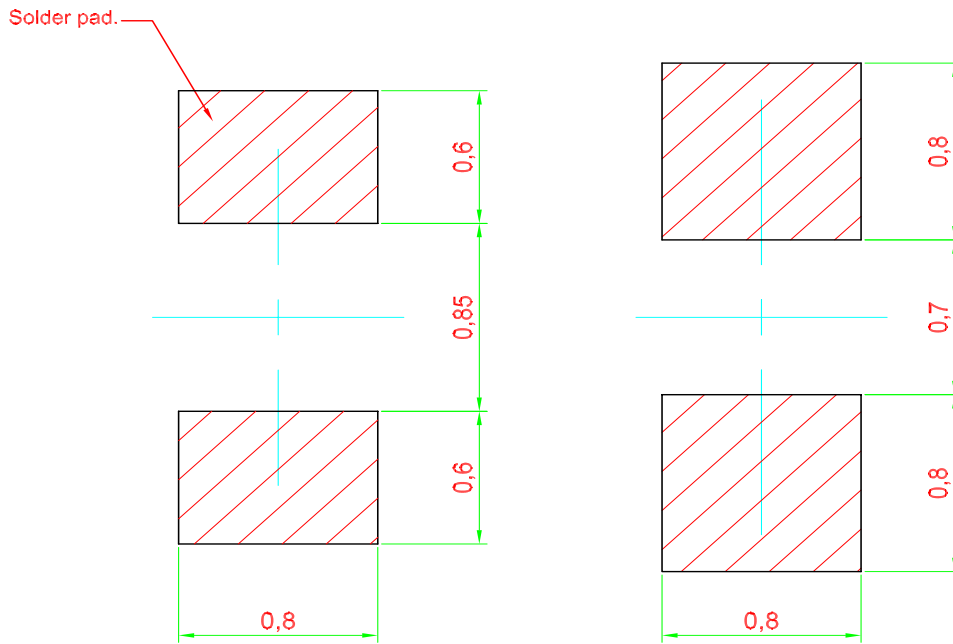

Recommended Solder-pad

Alternative Solder-pad
 Compatible to ChipLED 0603

Note: Component is based on a new package platform, which features “Bottom Only Terminations”. Solder joints are only formed at the bottom of the component and solder fillet will not be observable as the sides of the component.

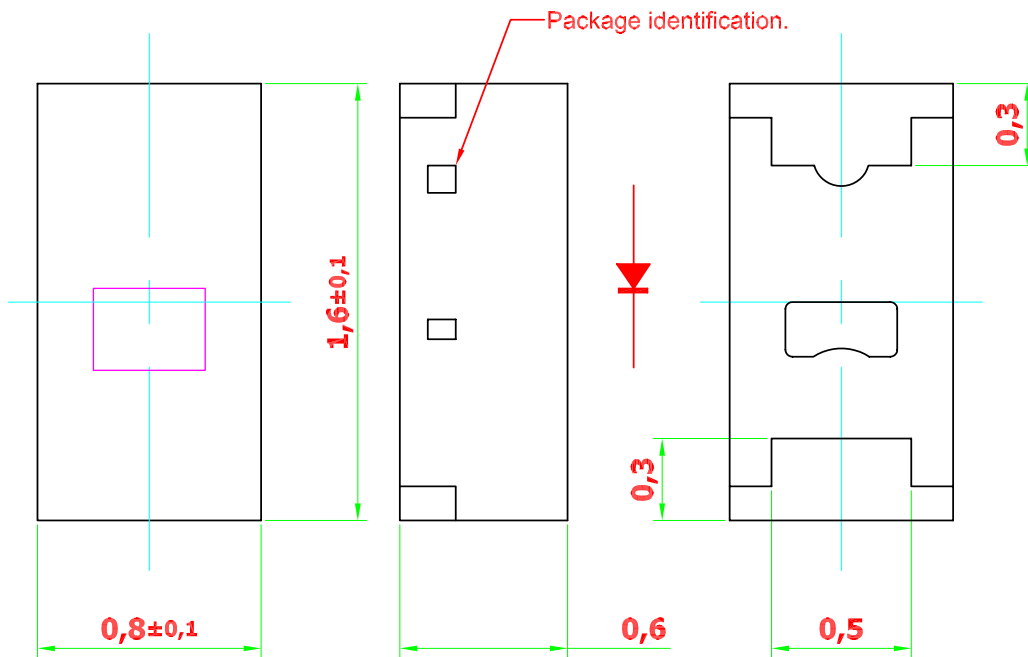

Surface are not intended for soldering

General Tolerances
± 0.10

Taping and orientation

- Reels come in quantity of 3000 units.
- Reel diameter is 180 mm.

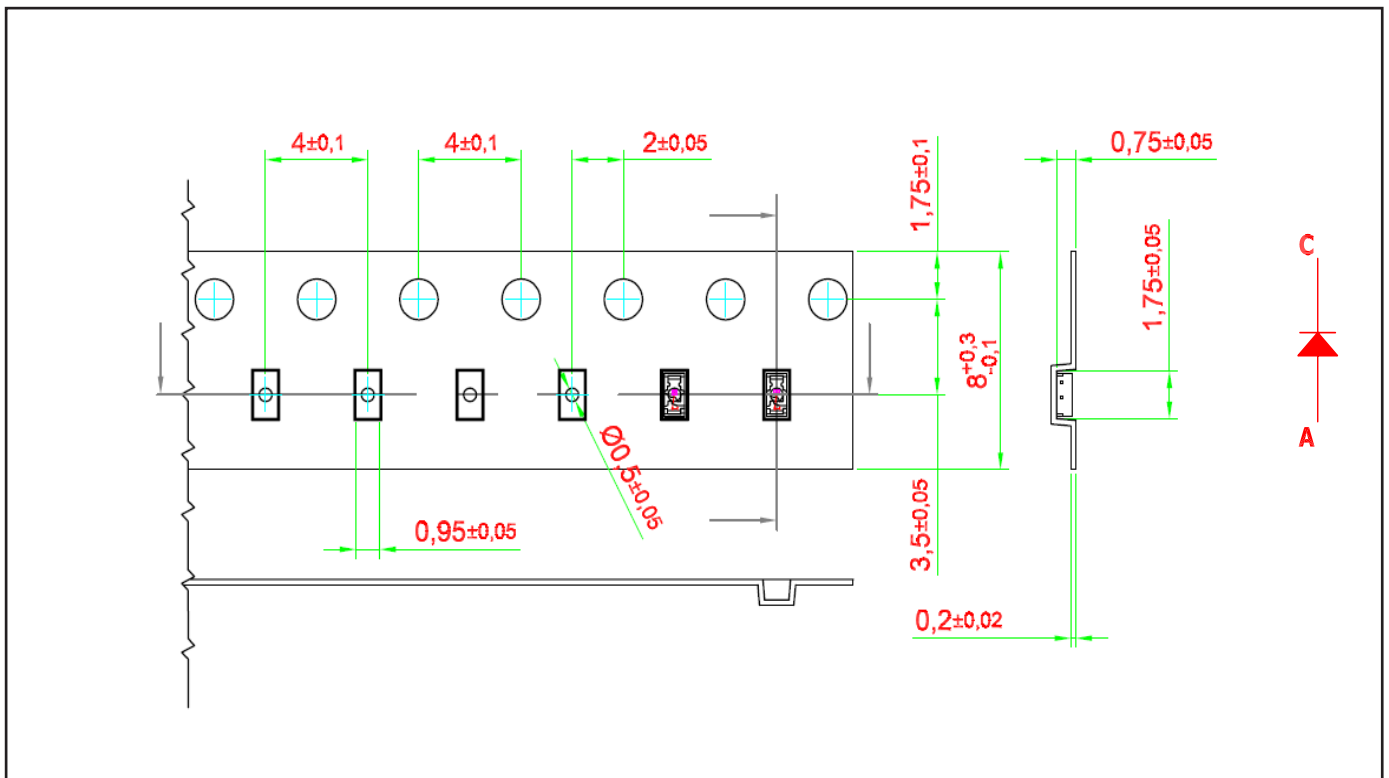

Packaging Specification

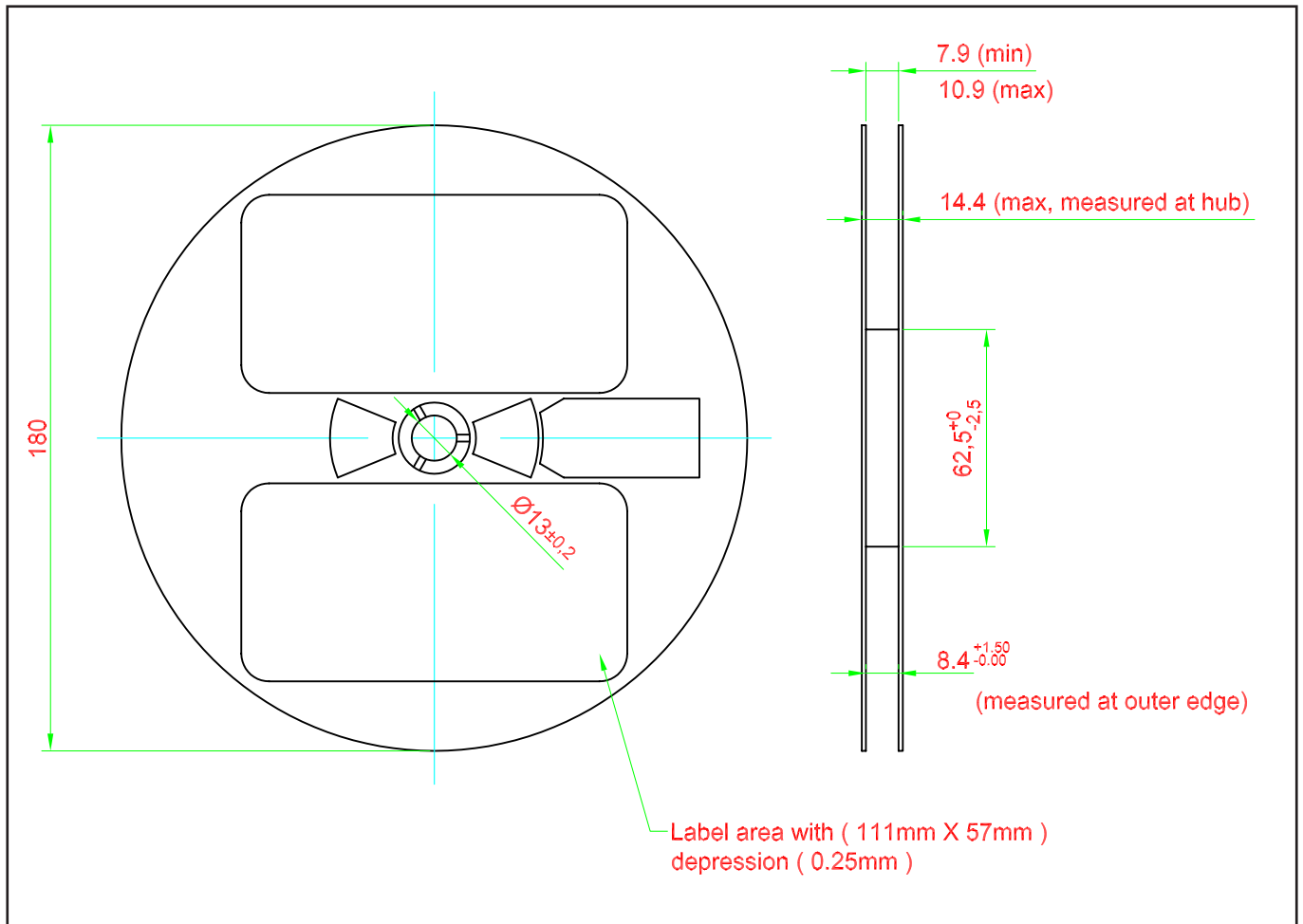

Packaging Specification

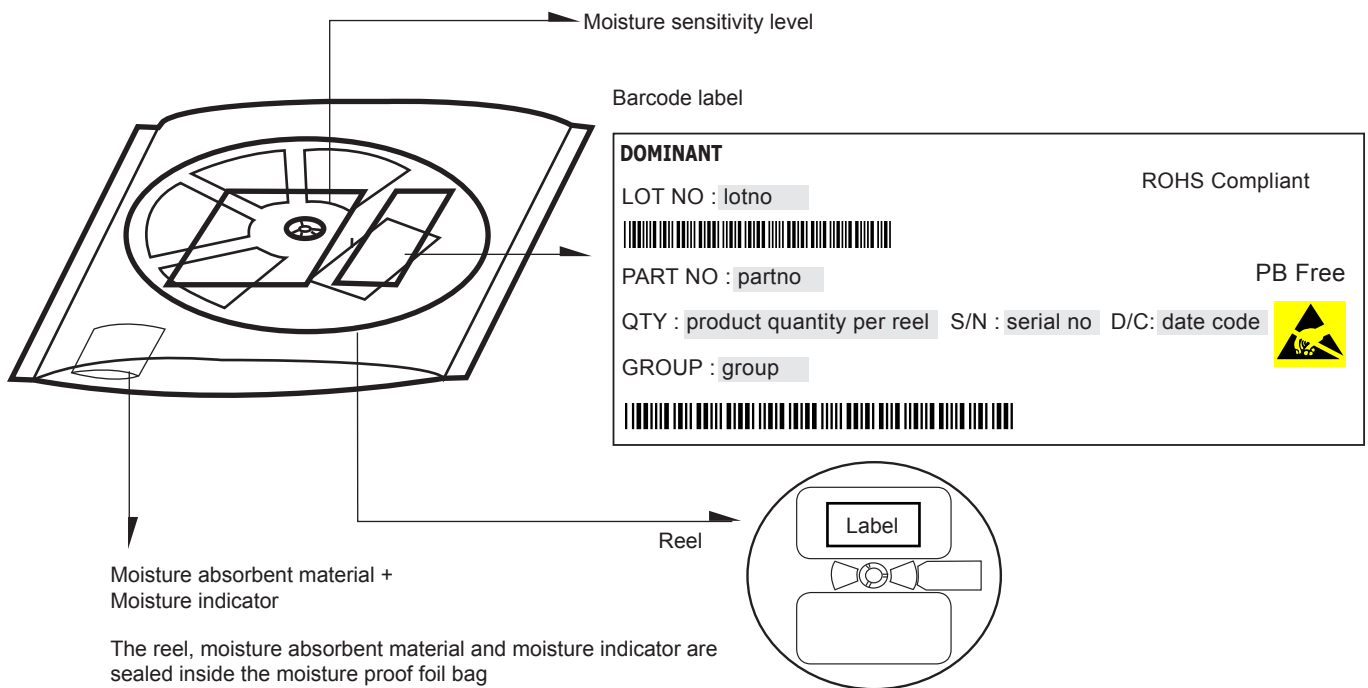

	Average 1pc SpiceLED	1 completed bag (3000pcs)
Weight (gram)	0.001	140 ± 10

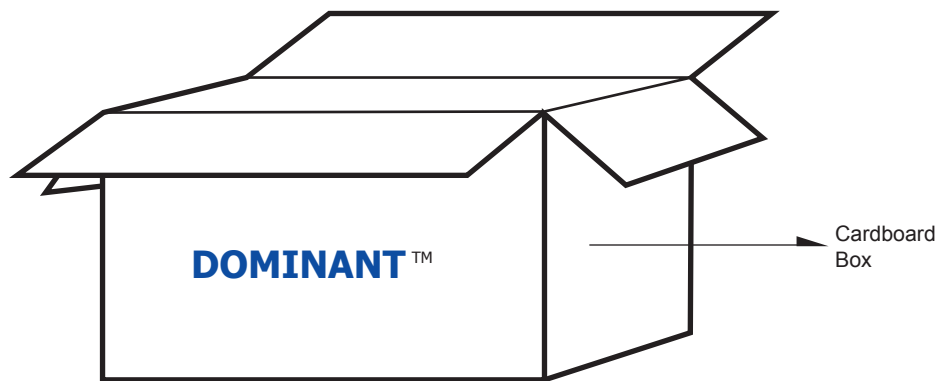

For SpiceLED™

Cardboard Box Size	Dimensions (mm)	Empty Box Weight (kg)	Reel / Box	Quantity / Box (pcs)
Small	300 x 250 x 250	0.58	15 reels MAX	45,000 MAX
Large	416 x 516 x 476	1.74	96 reels MAX	192,000 MAX

Recommended Pb-free Soldering Profile

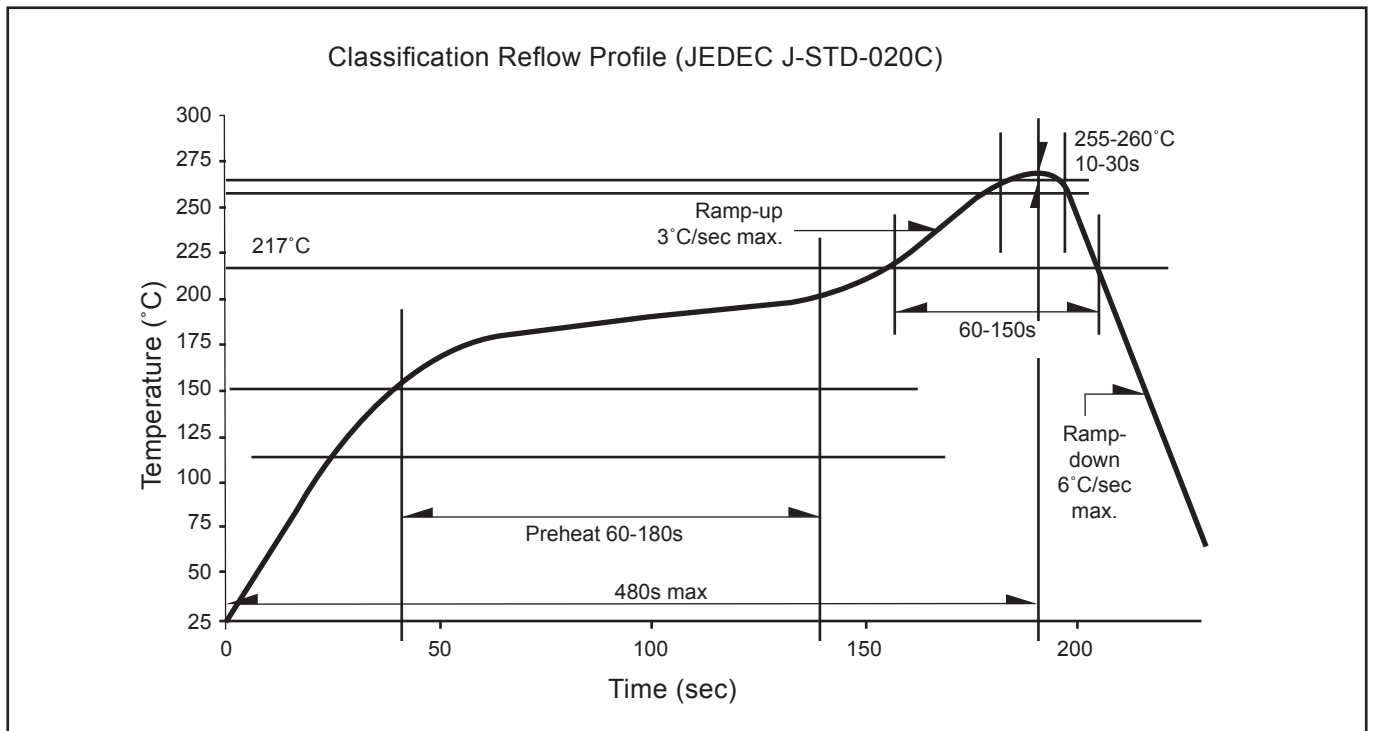

Revision History

Page	Subjects	Date of Modification
-	Initial release	14 Sep 2011
1, 2	Update Application Not for new design -> SSF-HLG-UV1-1	17 Dec 2012
8	Update Carrier Tape	13 Feb 2014

NOTE

All the information contained in this document is considered to be reliable at the time of publishing. However, DOMINANT Opto Technologies does not assume any liability arising out of the application or use of any product described herein.

DOMINANT Opto Technologies reserves the right to make changes to any products in order to improve reliability, function or design.

DOMINANT Opto Technologies products are not authorized for use as critical components in life support devices or systems without the express written approval from the Managing Director of DOMINANT Opto Technologies.

About Us

DOMINANT Opto Technologies is a dynamic Malaysian Corporation that is among the world's leading SMT LED Manufacturers. An excellence – driven organization, it offers a comprehensive product range for diverse industries and applications. Featuring an internationally certified quality assurance acclaim, DOMINANT's extra bright LEDs are perfectly suited for various lighting applications in the automotive, consumer and communications as well as industrial sectors. With extensive industry experience and relentless pursuit of innovation, DOMINANT's state-of-art manufacturing, research and testing capabilities have become a trusted and reliable brand across the globe. More information about DOMINANT Opto Technologies can be found on the Internet at <http://www.dominant-semi.com>.

Please contact us for more information:

Head Quarter

DOMINANT Opto Technologies Sdn. Bhd
Lot 6, Batu Berendam, FTZ Phase III, 75350 Melaka, Malaysia.
Tel: +606 283 3566 Fax: +606 283 0566
E-mail: sales@dominant-semi.com

