

## SBCB Series

### EMI In Data Line



These surface mount filters are specially designed to virtually eliminate the problems of conducted EMI in data line applications. They provide both differential and common mode noise attenuation.

These components contain tremendous electrode straight, solder heat resistance and outstanding solderability. These products are designed for flow, reflow and wave soldering required for surface mounting applications.

### Features

- These components are compatible with auto insertion equipment and easy installed for PC board.
- With four lines for voice and data line.
- Compact and high performance.

### Applications

- Attenuating noise of analog and digital signals for telecommunication devices.
- Prevention of interference from amateur radios, CB stations, or high frequency welders, etc.

### Product Identification

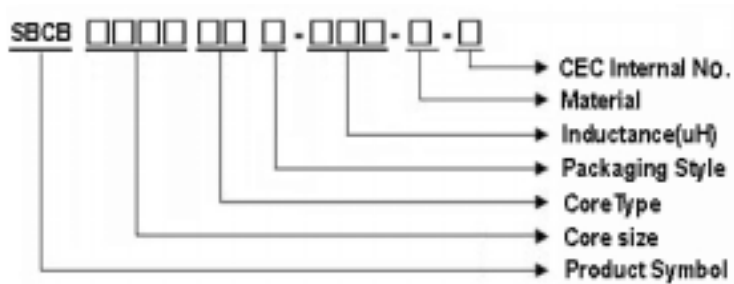

- Packaging: T : Tape and Reel
- Note: lead-free

### Shapes and Dimensions

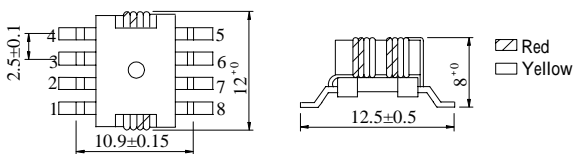

### Recommended Pattern

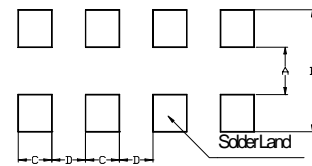

Dimensions in mm

TYPE	A	B	C	D
SBCB1104	8.0	13.0 ~ 14.0	1.15	2.0

**Electrical Characteristics**

Part Number	Test Frequency (KHz) 0.6V	Inductance L(μH)	DC Resistance ( ) Max
SBCB1104RIT-330-B3-N	100	25~50	0.07

**Test Instruments :** HP4192A LF Impedance Analyzer

**SBCB1104RI-330-B3-N**

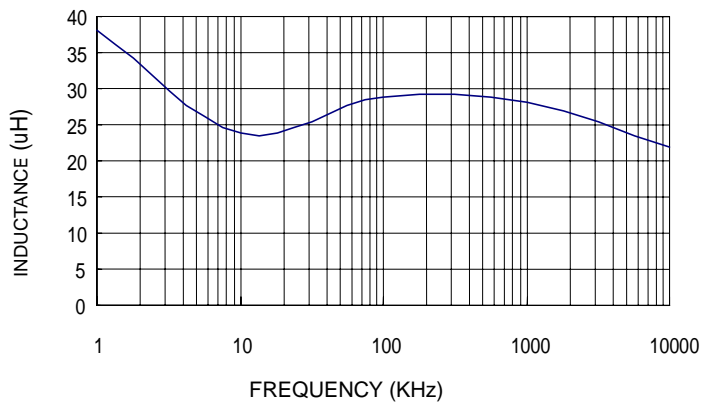

## Packaging Specifications

### Tape Dimensions

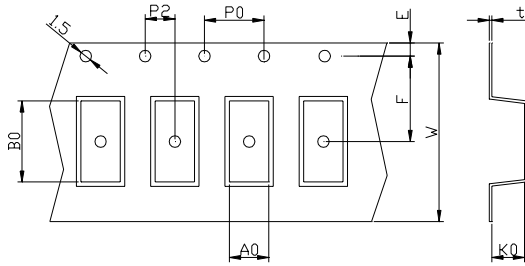

### Tape Material

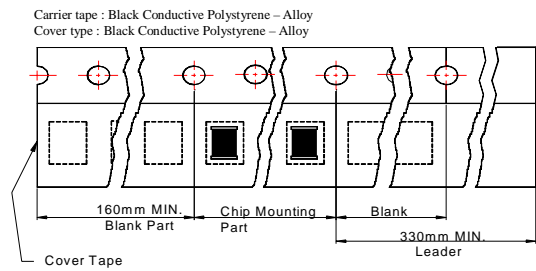

### Reel Dimensions

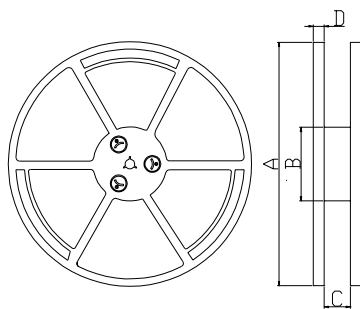

### Dimensions in mm

TYPE	Tape Dimensions									Reel Dimensions				Quantity
	W	E	F	P0	P2	A0	B0	K0	t	A	B	C	D	PCS / Reel
SBCB1104	24	1.75	11.5	4	2	12.4	15.5	9.1	0.36	330	100	24.4	2.4	350