

Features

- 3.2mmx1.6mm SMT LED. 1.0mm THICKNESS.
- LOW POWER CONSUMPTION.
- WIDE VIEWING ANGLE.
- IDEAL FOR BACKLIGHT AND INDICATOR.
- VARIOUS COLORS AND LENS TYPES AVAILABLE.

APTR3216MBW BLUE

Package Dimensions

Description

The Blue source color devices are made with GaN on SiC Light Emitting Diode.

Static electricity and surge damage the LEDs. It is recommended to use a wrist band or anti-electrostatic glove when handling the LEDs.

All devices, equipment and machinery must be electrically grounded.

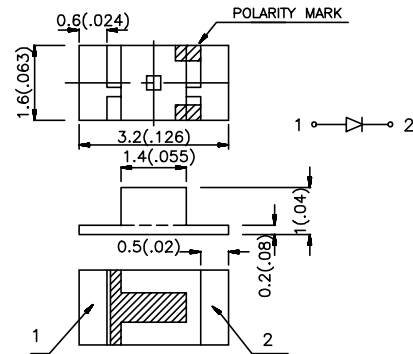

Notes:

1. All dimensions are in millimeters (inches).
2. Tolerance is ± 0.2 (0.0079") unless otherwise noted.
3. Lead spacing is measured where the lead emerge package.
4. Specifications are subjected to change without notice.

Selection Guide

Part No.	Dice	Lens Type	Iv (mcd) @ 20 mA		Viewing Angle
			Min.	Typ.	θ1/2
APTR3216MBW	BLUE (GaN)	WHITE DIFFUSED	2	8	120°

Note:

1. θ1/2 is the angle from optical centerline where the luminous intensity is 1/2 the optical centerline value.

Electrical / Optical Characteristics at T_A=25°C

Symbol	Parameter	Device	Typ.	Max.	Units	Test Conditions
λ_{peak}	Peak Wavelength	Blue	430		nm	IF=20mA
$\Delta\lambda_{1/2}$	Spectral Line Halfwidth	Blue	65		nm	IF=20mA
C	Capacitance	Blue	100		pF	VF=0V;f=1MHz
V _F	Forward Voltage	Blue	3.8	4.5	V	IF=20mA
I _r	Reverse Current	All		10	uA	VR = 5V

Absolute Maximum Ratings at T_A=25°C

Parameter	Blue	Units
Power dissipation	105	mW
DC Forward Current	30	mA
Peak Forward Current [1]	200	mA
Reverse Voltage	5	V
Operation/Storage Temperature	-40°C To +85°C	

Notes:

- 1/10 Duty Cycle, 0.1ms Pulse Width.
- 4mm below package base.

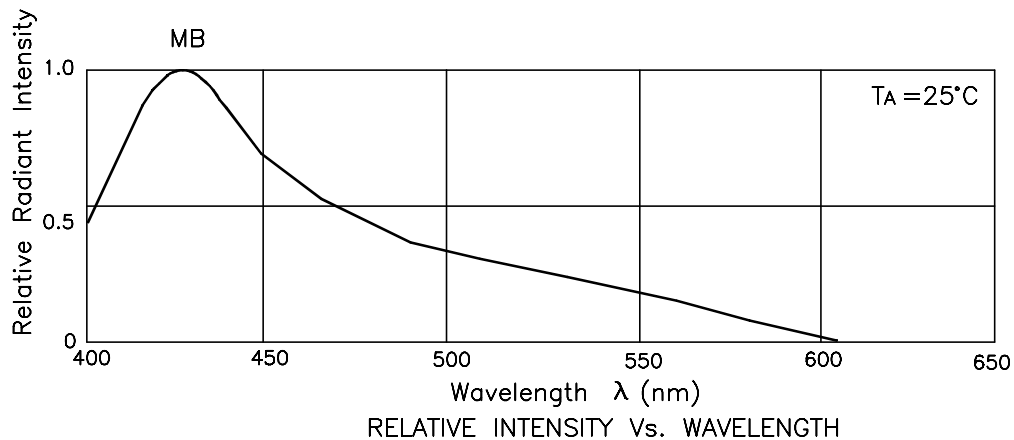

Blue APTR3216MBW

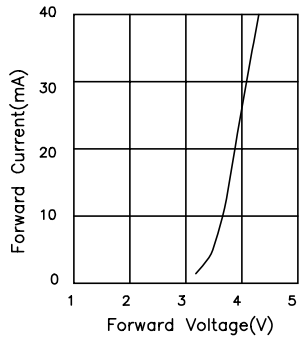

FORWARD CURRENT Vs. FORWARD VOLTAGE

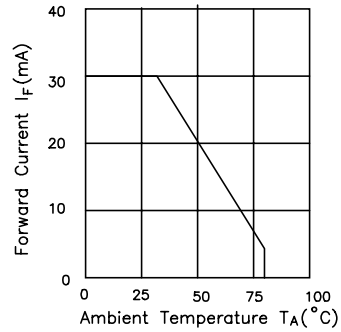

FORWARD CURRENT DERATING CURVE

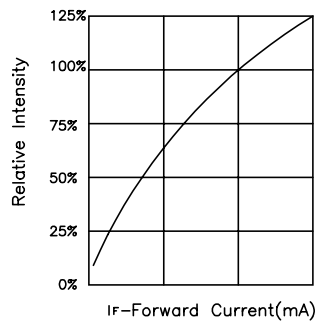

RELATIVE INTENSITY Vs. FORWARD CURRENT

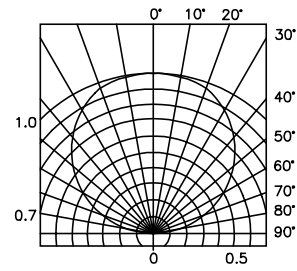

SPATIAL DISTRIBUTION

APTR3216MBW SMT Reflow Soldering Instructions

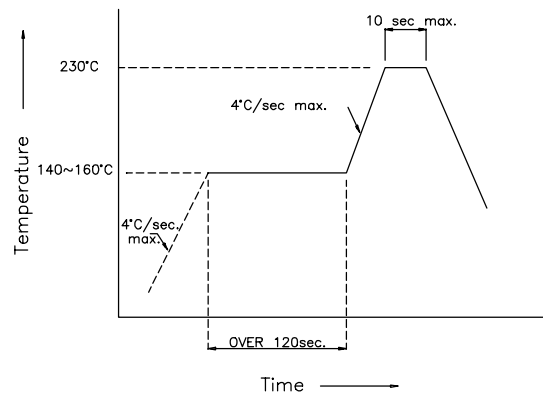

APTR3216MBW Recommended Soldering Pattern (Units : mm)

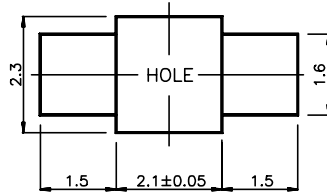

APTR3216MBW Tape Specifications (Units : mm)

