

Description

The AL8807BQ is a step-down DC/DC converter designed to drive LEDs with a constant current. The device can drive up to 9 LEDs, depending on the forward voltage of the LEDs, in series from a voltage source of 6V to 30V. Series connection of the LEDs provides identical LED currents resulting in uniform brightness and eliminating the need for ballast resistors. The AL8807BQ switches at frequency up to 1MHz with controlled rise and fall times to reduce EMI. This allows the use of small size external components, hence minimizing the PCB area needed.

Maximum output current of AL8807BQ is set via an external resistor connected between the V_{IN} and SET input pins. Dimming is achieved by applying a PWM signal at the CTRL input pin. An input voltage of 0.4V or lower at CTRL switches off the output MOSFET simplifying PWM dimming.

Features

- LED driving current up to 1.3A
- Better than 5% accuracy
- High efficiency up to 96%
- Optimally controlled switching speeds
- Operating input voltage from 6V to 30V
- PWM input for dimming control
- Open-Circuit LED protection
- LED Chain Short Circuited
- Over-Temperature Protection
- MSOP-8EP Available in "Green" Molding Compound (No Br, Sb) with lead Free Finish/ RoHS Compliant
 - **Totally Lead-Free & Fully RoHS Compliant (Notes 1 & 2)**
 - **Halogen and Antimony Free. "Green" Device (Note 3)**
- Automotive Grade
 - **Qualified to AEC-Q100 Standards for High Reliability**
 - **PPAP Capable (Note 4)**

- Notes:
1. No purposely added lead. Fully EU Directive 2002/95/EC (RoHS) & 2011/65/EU (RoHS 2) compliant.
 2. See http://www.diodes.com/quality/lead_free.html for more information about Diodes Incorporated's definitions of Halogen- and Antimony-free, "Green" and Lead-free.
 3. Halogen- and Antimony-free "Green" products are defined as those which contain <900ppm bromine, <900ppm chlorine (<1500ppm total Br + Cl) and <1000ppm antimony compounds.
 4. Automotive products are AEC-Q100 qualified and are PPAP capable. Automotive, AEC-Q100 and standard products are electrically and thermally the same, except where specified. For more information, please refer to http://www.diodes.com/quality/product_compliance_definitions/.

Pin Assignments

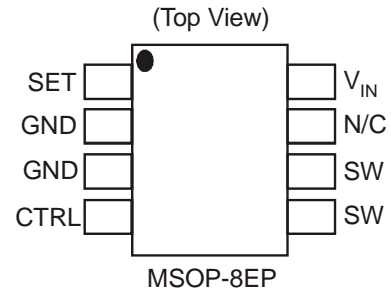

Applications

- Automotive Lamps

Typical Application Circuit

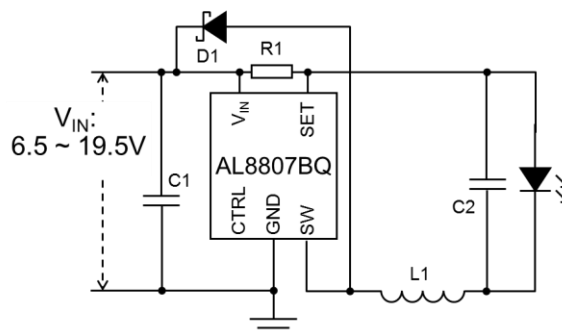

Pin Descriptions

Pin Name	Pin Number	Function
SET	1	Set Nominal Output Current Pin. Configure the output current of the device.
GND	2, 3	GND Pins
CTRL	4	Dimming and On/Off Control Input. <ul style="list-style-type: none"> • Leave floating for normal operation. ($V_{CTRL} = V_{REF} = 2.5V$ giving nominal average output current $I_{OUTnom} = 0.1/R_s$) • Drive to voltage below 0.4V to turn off output current • A PWM signal ($\geq 2.5V$) allows the output current to be adjusted below the level set by the resistor connected to SET input pin.
SW	5, 6	Switch Pin. Connect inductor/freewheeling diode here, minimizing track length at this pin to reduce EMI.
N/C	7	no connection
V_{IN}	8	Input Supply Pin. Must be locally decoupled to GND with $\geq 2.2\mu F$ X7R ceramic capacitor – see applications section for more information.
EP	EP	Exposed pad/TAB connects to GND and thermal mass for enhanced thermal impedance. Should not be used as electrical ground conduction path.

Functional Block Diagram

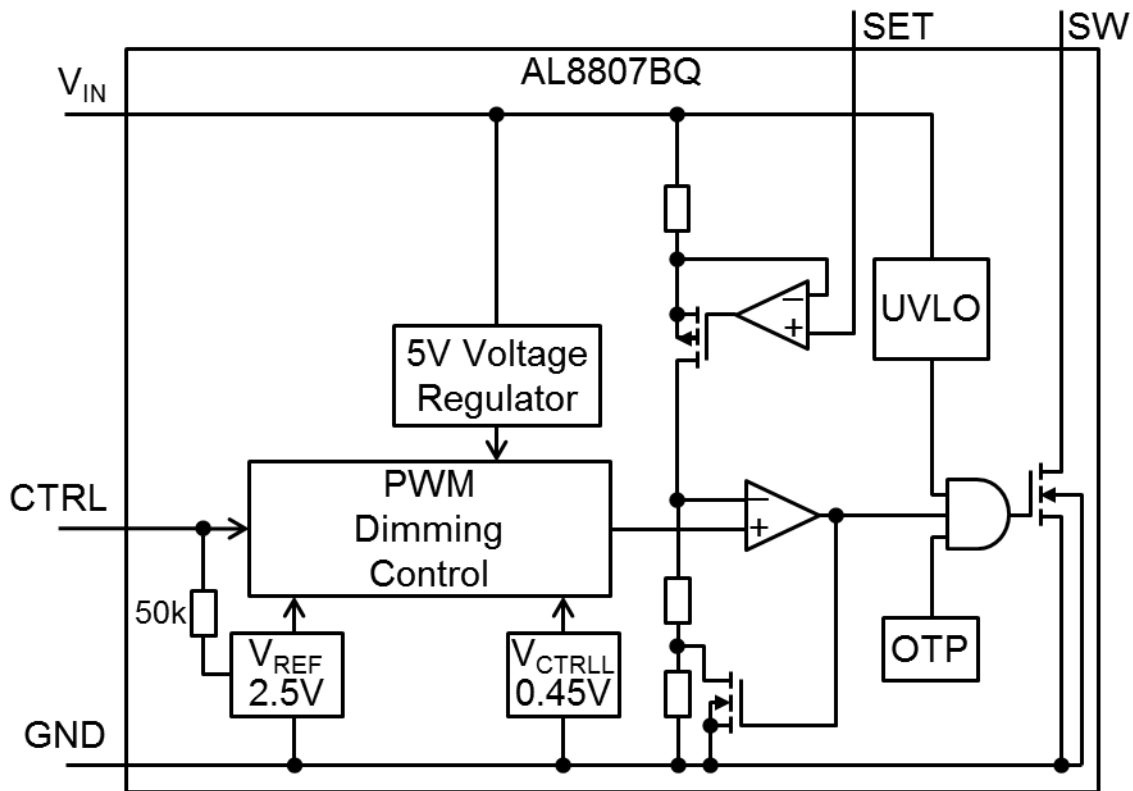

Absolute Maximum Ratings

Symbol	Parameter	Ratings	Unit	
ESD HBM	Human Body Model ESD Protection	4	kV	
ESD MM	Machine Model ESD Protection	300	V	
ESD CDM	Charged Device Model ESD Protection	1000	V	
V _{IN}	Continuous V _{IN} Pin Voltage Relative to GND	-0.3 to +40	V	
V _{SW}	SW Voltage Relative to GND	-0.3 to +40	V	
V _{CTRL}	CTRL Pin Input Voltage	-0.3 to +6	V	
I _{SW-RMS}	DC or RMS Switch Current	MSOP-8EP	1.6	A
I _{SW-PK}	Peak Switch Current (<10%)		2.5	A
T _J	Junction Temperature		+150	°C
T _{LEAD}	Lead Temperature Soldering		+300	°C
T _{ST}	Storage Temperature Range		-65 to +150	°C

Caution: Stresses greater than the 'Absolute Maximum Ratings' specified above, may cause permanent damage to the device. These are stress ratings only; functional operation of the device at these or any other conditions exceeding those indicated in this specification is not implied. Device reliability may be affected by exposure to absolute maximum rating conditions for extended periods of time.
Semiconductor devices are ESD sensitive and may be damaged by exposure to ESD events. Suitable ESD precautions should be taken when handling and transporting these devices.

Semiconductor devices are ESD sensitive and may be damaged by exposure to ESD events. Suitable ESD precautions should be taken when handling and transporting these devices.

Recommended Operating Conditions

Symbol	Parameter	Min	Max	Unit
V _{IN}	Operating Input Voltage Relative to GND	6.0	30	V
V _{CTRLH}	Voltage High for PWM Dimming Relative to GND	2.5	5.5	V
V _{CTRL}	Voltage Low for PWM Dimming Relative to GND	0	0.4	V
f _{SW}	Maximum Switching Frequency	—	1	MHz
I _{SW}	Continuous Switch Current	—	1.3	A
T _J	Junction Temperature Range	-40	+125	°C

Electrical Characteristics (V_{IN} = 12V, @T_A = +25°C, unless otherwise specified.)

Symbol	Parameter	Conditions	Min	Typ	Max	Unit
V _{INSU}	Internal Regulator Start Up Threshold	V _{IN} rising	—	—	5.9	V
V _{INSH}	Internal Regulator Hysteresis Threshold	V _{IN} falling	100	—	300	mV
I _Q	Quiescent Current	Output not switching (Note 5)	—	—	350	µA
I _S	Input Supply Current	CTRL pin floating f = 250kHz	—	1.8	5	mA
V _{TH}	Set Current Threshold Voltage	—	95	100	105	mV
V _{TH-H}	Set Threshold Hysteresis	—	—	±15	—	mV
I _{SET}	SET Pin Input Current	V _{SET} = V _{IN} -0.1	—	16	22	µA
R _{CTRL}	CTRL Pin Input Resistance	Referred to internal reference	—	50	—	kΩ
V _{REF}	Internal Reference Voltage	—	—	2.5	—	V
R _{DS(ON)}	On Resistance of SW MOSFET	I _{SW} = 1A	—	0.25	0.4	Ω
t _R	SW Rise Time	V _{SENSE} = 100 ±20mV f _{SW} = 250kHz	—	12	—	ns
t _F	SW Fall Time	V _{SW} = 0.1V~12V~0.1V C _L = 15pF	—	20	—	ns
T _{OTP}	Over-Temperature Shutdown	—	—	155	—	°C
T _{OTP-Hyst}	Over-Temperature Hysteresis	—	—	55	—	°C
I _{SW_Leakage}	Switch Leakage Current	V _{IN} =30V	—	—	0.5	µA
θ _{JA}	Thermal Resistance Junction-to-Ambient (Note 6)	(Note 7)	—	69	—	°C/W
θ _{JC}	Thermal Resistance Junction-to-case (Note 8)	(Note 7)	—	4.3	—	—

Notes: 5. AL8807BQ does not have a low power standby mode but current consumption is reduced when output switch is inhibited: V_{SENSE} = 0V. Parameter is tested with V_{CTRL} ≤ 2.5V.

6. Refer to figure 39 for the device derating curve.

7. Test condition for MSOP-8EP: Device mounted on FR-4 PCB (51mm x 51mm 2oz copper, minimum recommended pad layout on top layer and thermal vias to bottom layer with maximum area ground plane. For better thermal performance, larger copper pad for heat-sink is needed.

8. Dominant conduction path is via exposed pad.

Typical Performance Characteristics (@ $T_A = +25^\circ\text{C}$, unless otherwise specified.)

NEW PRODUCT

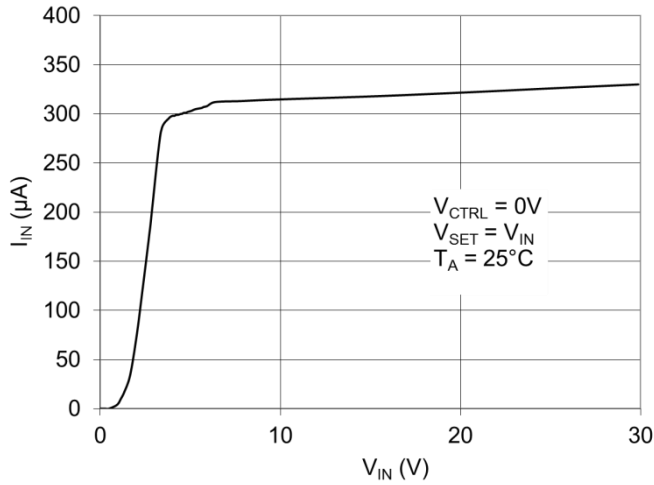

Figure 1. Supply Current (notswitching vs. Input Voltage)

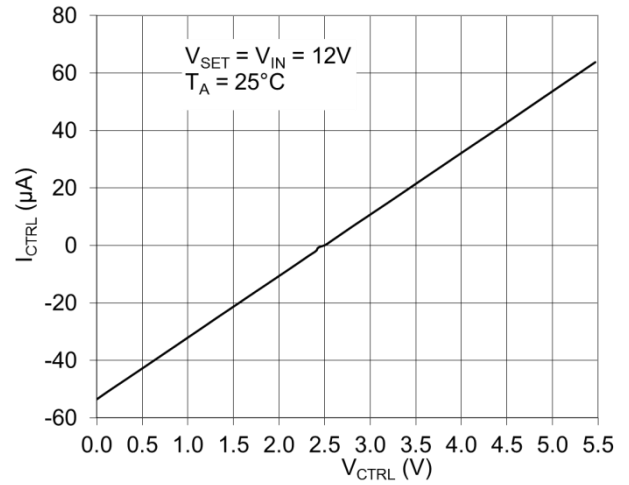

Figure 2 I_{CTRL} vs. V_{CTRL}

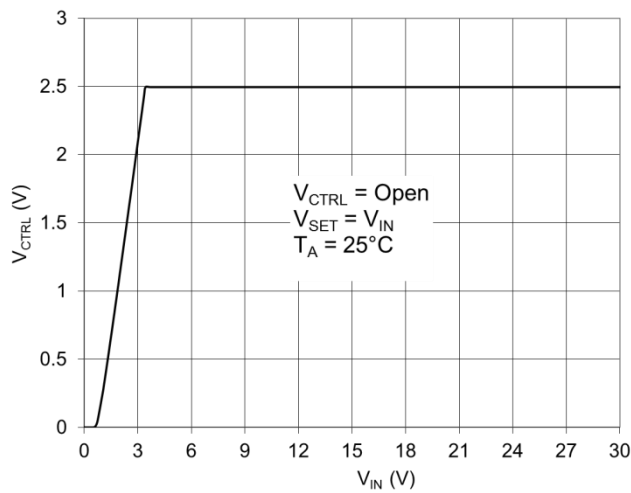

Figure 3 V_{CTRL} vs. Input Voltage (CTRL Pin open circuit)

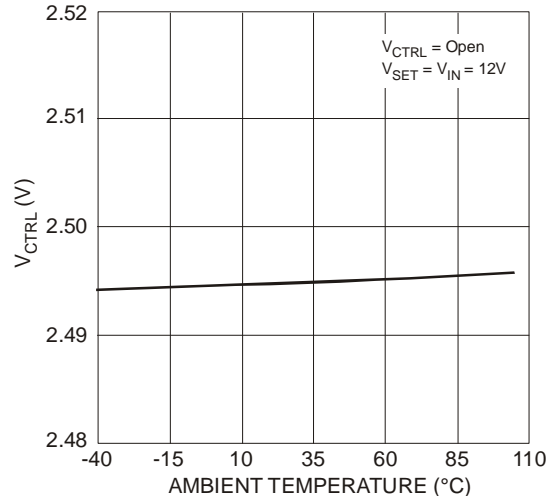

Figure 4 V_{CTRL} vs. Temperature

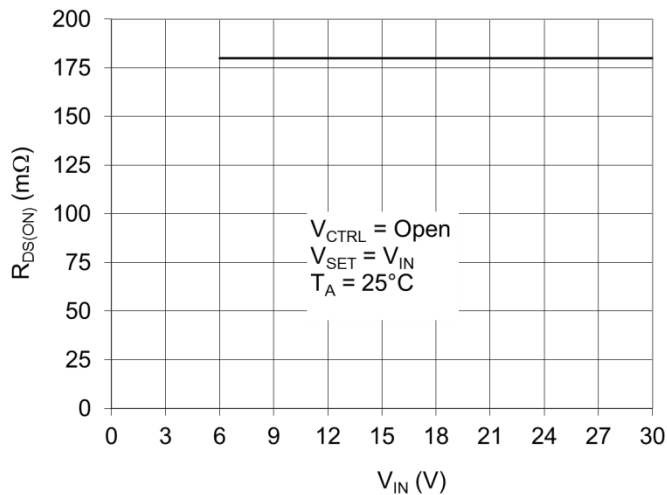

Figure 5 SW $R_{DS(ON)}$ vs. Input Voltage

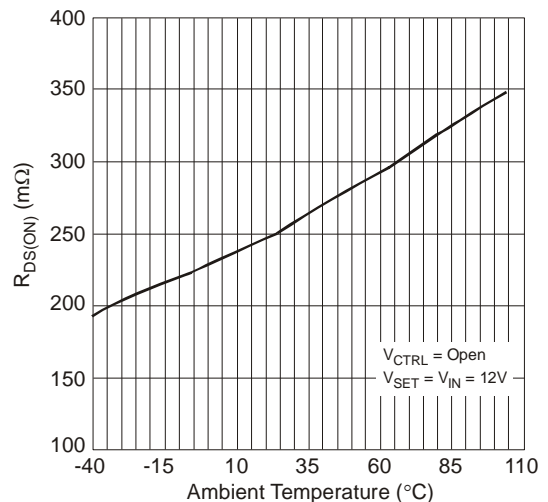

Figure 6 SW $R_{DS(ON)}$ vs. Temperature

Typical Performance Characteristics (cont.) (@ $T_A = +25^\circ\text{C}$, unless otherwise specified.)

NEW PRODUCT

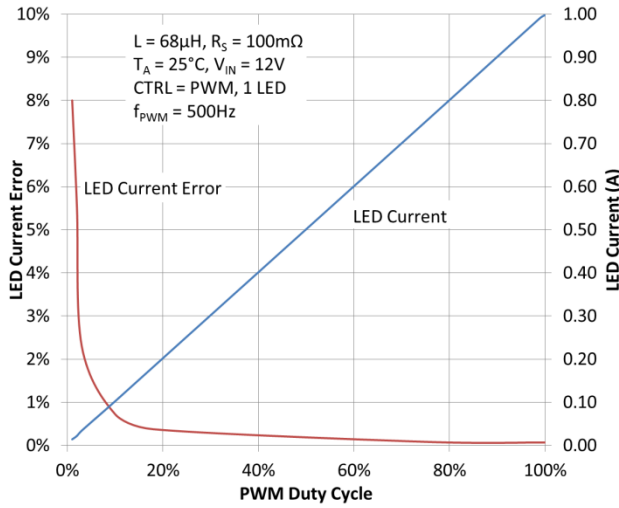

Figure 7 I_{LED} vs. PWM Duty Cycle

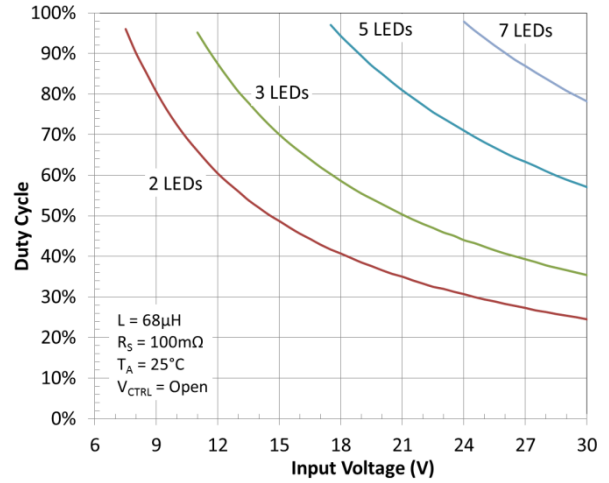

Figure 8. Duty Cycle vs. Input Voltage

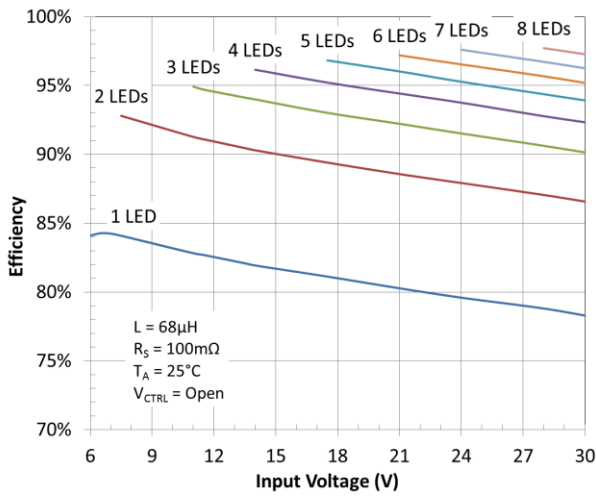

Figure 9. Efficiency vs. Input Voltage

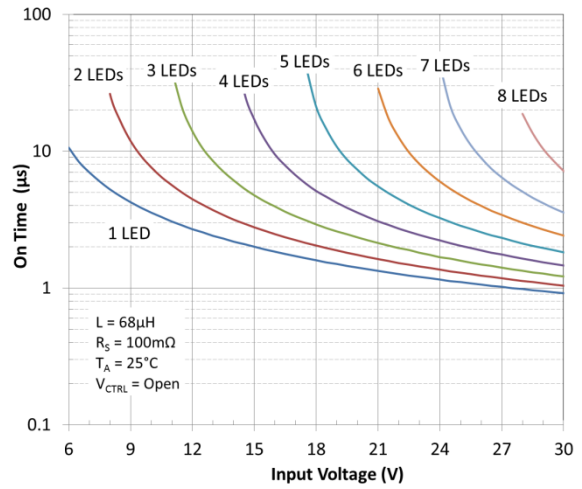

Figure 10. On-time vs. Input Voltage

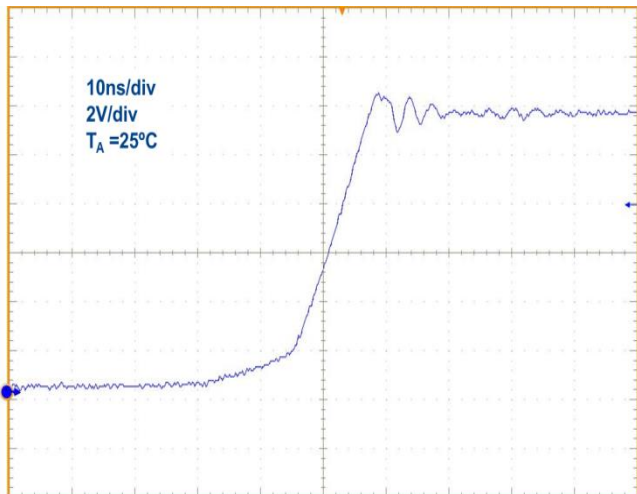

Figure 11 SW Output Rise Time

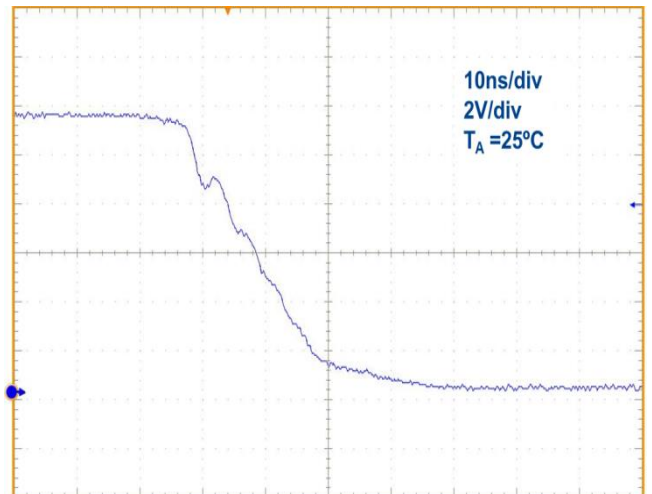

Figure 12 SW Output Fall Time

Typical Performance Characteristics (670mA LED current) (@ $T_A = +25^\circ\text{C}$, unless otherwise specified.)

NEW PRODUCT

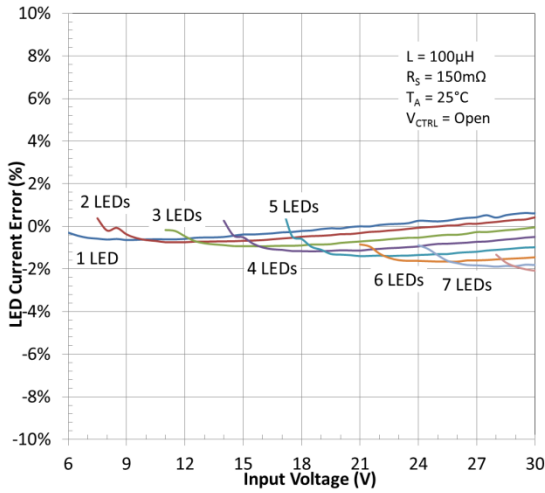

Figure 13. LED Current Deviation vs. Input Voltage

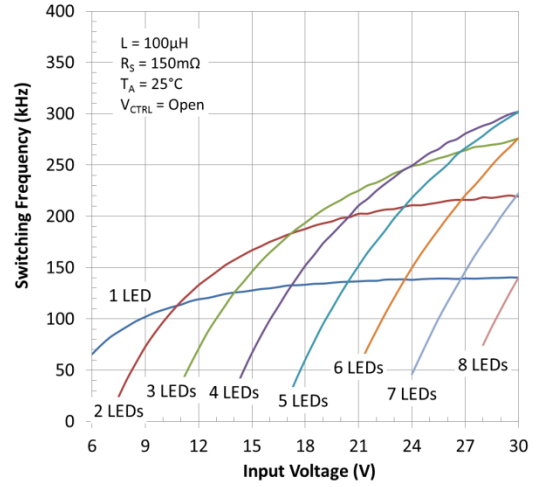

Figure 14. Switching Frequency vs. Input Voltage

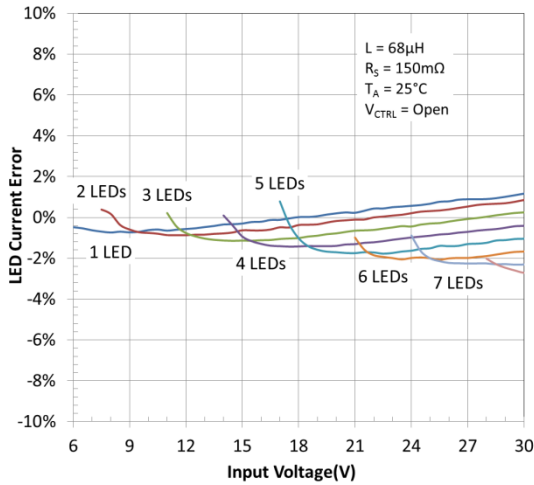

Figure 15. LED Current Deviation vs. Input Voltage

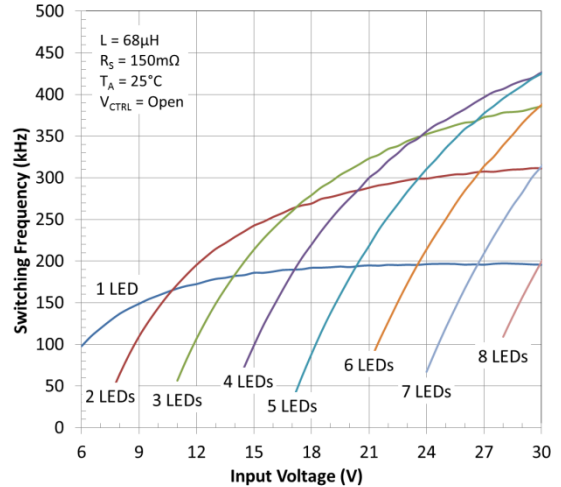

Figure 16. Switching Frequency vs. Input Voltage

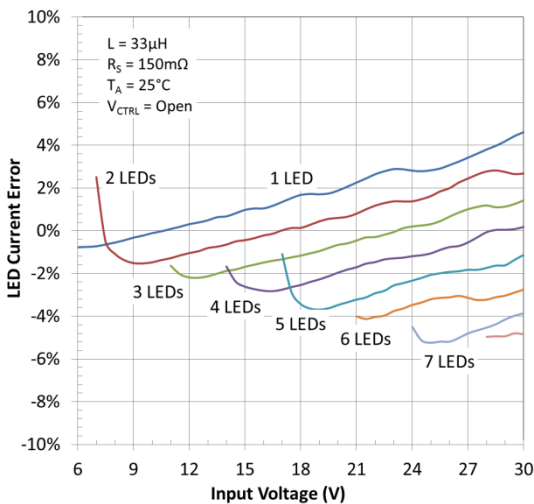

Figure 17. LED Current Deviation vs. Input Voltage

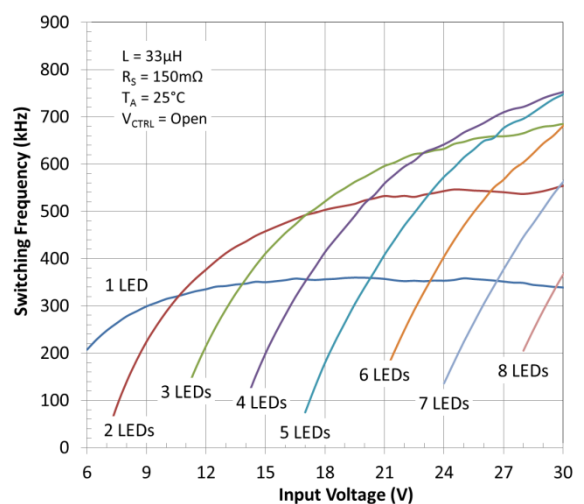

Figure 18. Switching Frequency vs. Input Voltage

Typical Performance Characteristics (1A LED current) (@ $T_A = +25^\circ\text{C}$, unless otherwise specified.)

NEW PRODUCT

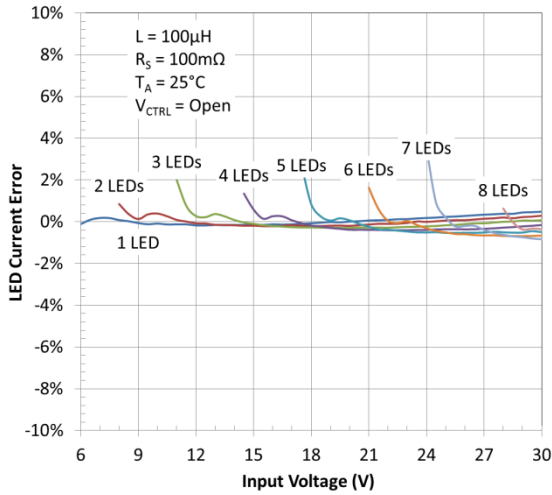

Figure 19. LED Current Deviation vs. Input Voltage

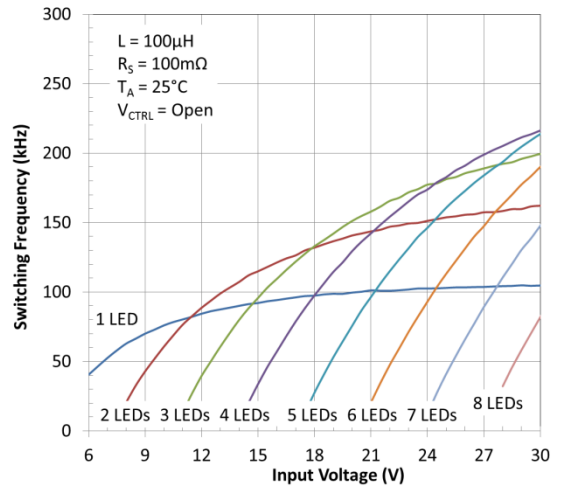

Figure 20. Switching Frequency vs. Input Voltage

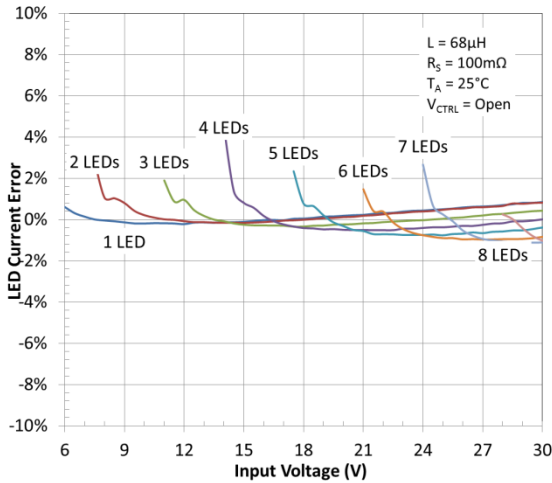

Figure 21. LED Current Deviation vs. Input Voltage

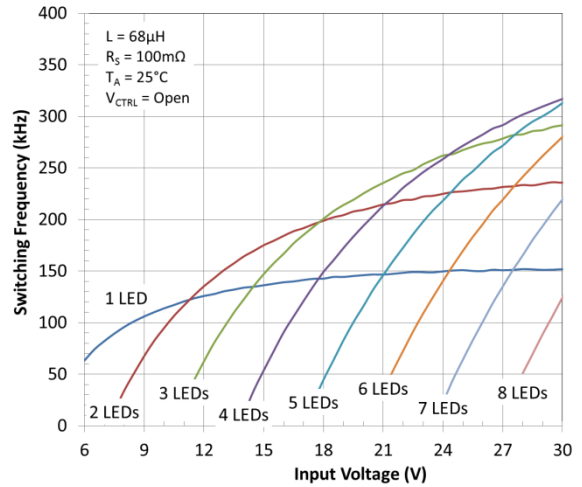

Figure 22. Switching Frequency vs. Input Voltage

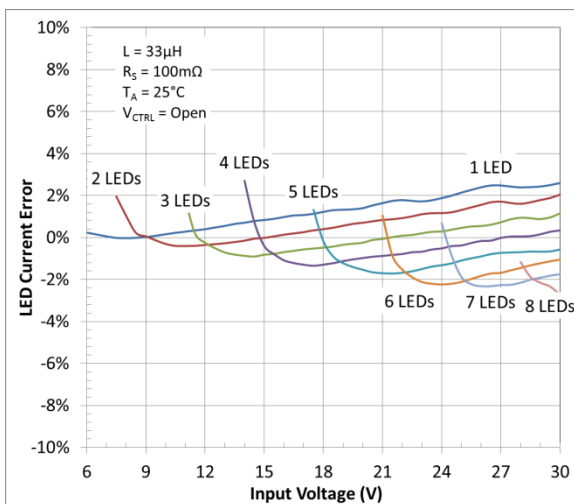

Figure 23. LED Current Deviation vs. Input Voltage

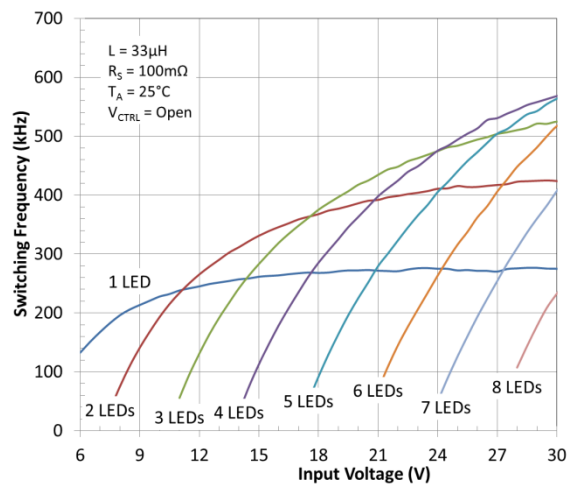

Figure 24. Switching Frequency vs. Input Voltage

Typical Performance Characteristics (1.3A LED current) (@ $T_A = +25^\circ\text{C}$, unless otherwise specified.)

NEW PRODUCT

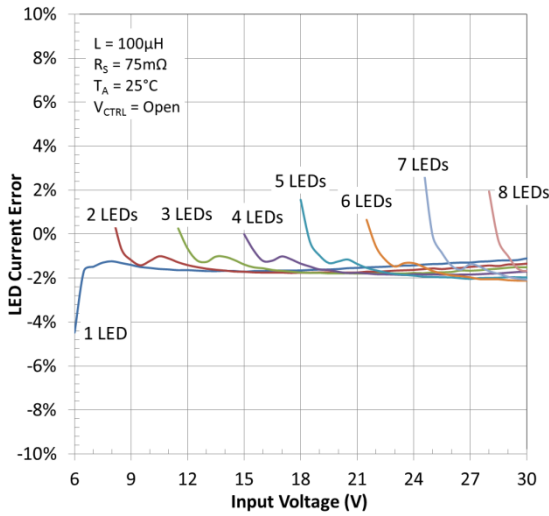

Figure 25. LED Current Deviation vs. Input Voltage

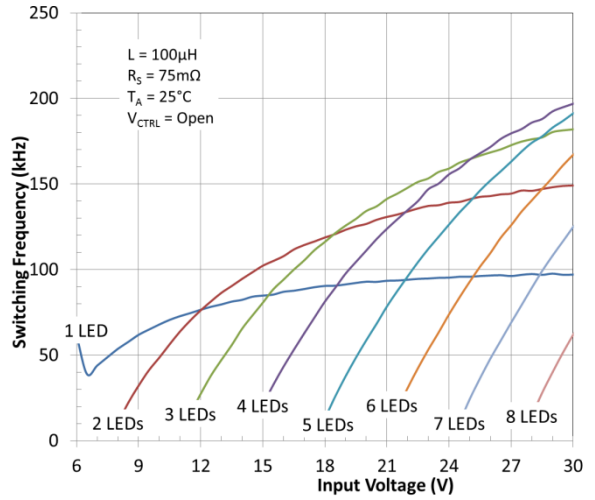

Figure 26. Switching Frequency vs. Input Voltage

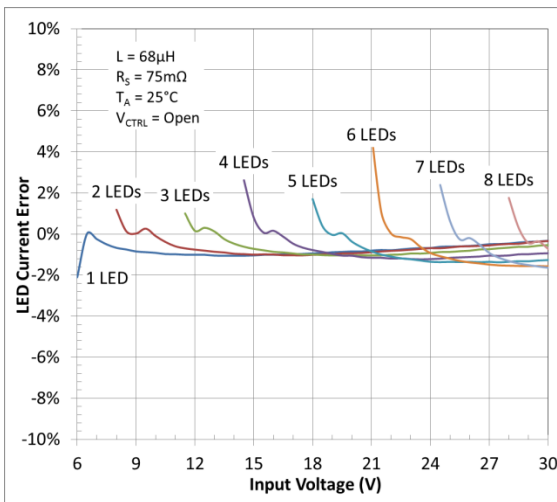

Figure 27. LED Current Deviation vs. Input Voltage

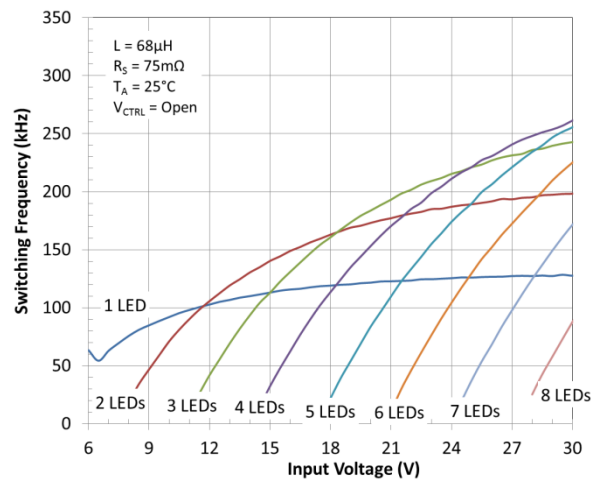

Figure 28. Switching Frequency vs. Input Voltage

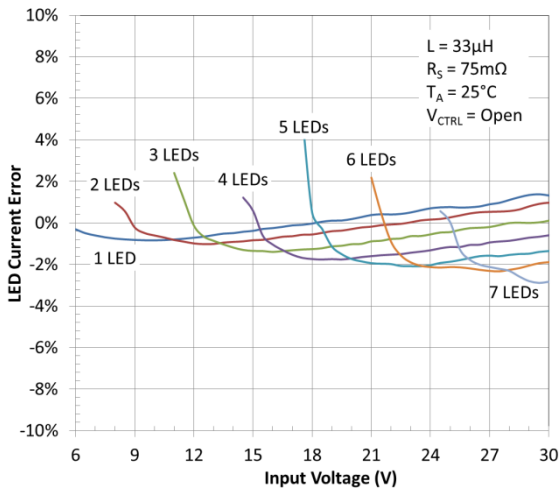

Figure 29. LED Current Deviation vs. Input Voltage

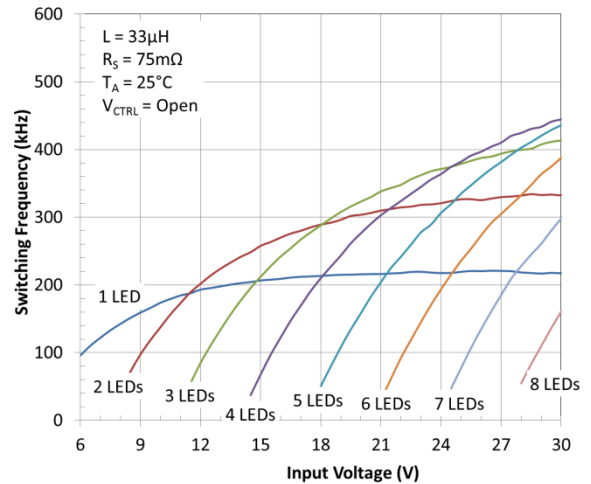

Figure 30. Switching Frequency vs. Input Voltage

Application Information

The AL8807BQ is a hysteretic (also known as equal ripple) LED driver with integrated power switch. It is available in two packages that provide a PCB area-power dissipation capability compromise. It is recommended that at higher LED currents/smaller PCBs that the MSOP-8EP version is used to maximize the allowable LED current over a wider ambient temperature range.

AL8807BQ Operation

In normal operation, when voltage is applied at +V_{IN}, the AL8807BQ internal switch is turned on. Current starts to flow through sense resistor R₁, inductor L1, and the LEDs. The current ramps up linearly, and the ramp rate is determined by the input voltage +V_{in} and the inductor L1.

This rising current produces a voltage ramp across R₁. The internal circuit of the AL8807BQ senses the voltage across R₁ and applies a proportional voltage to the input of the internal comparator.

When this voltage reaches an internally set upper threshold, the internal switch is turned off. The inductor current continues to flow through R₁, L1, the LEDs and the schottky diode D1, and back to the supply rail, but it decays, with the rate of decay determined by the forward voltage drop of the LEDs and the schottky diode.

This decaying current produces a falling voltage at R₁, which is sensed by the AL8807BQ. A voltage proportional to the sense voltage across R₁ is applied at the input of the internal comparator. When this voltage falls to the internally set lower threshold, the internal switch is turned on again.

This switch-on-and-off cycle continues to provide the average LED current set by the sense resistor R₁.

LED Current Control

The LED current is controlled by the resistor R1 in Figure 31.

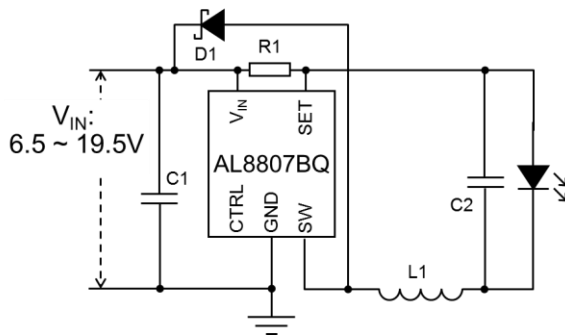

Figure 31 Typical Application Circuit

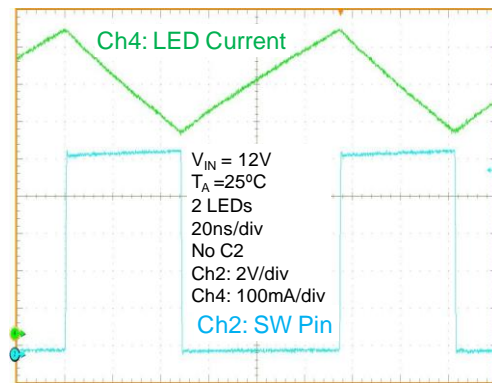

Figure 32 Typical Operating Waveform (C2 not fitted)

Connected between V_{IN} and SET the nominal average output current in the LED(s) is defined as:

$$I_{LED} = \frac{V_{THD}}{R1}$$

For example for a desired LED current of 660mA and a default voltage V_{CTRL}=2.5V the resulting resistor is:

$$R1 = \frac{V_{THD}}{I_{LED}} = \frac{0.1}{0.66} \approx 150m\Omega$$

Applications Information (cont.)

PWM Dimming

LED current can be adjusted digitally, by applying a low frequency Pulse Width Modulated (PWM) logic signal to the CTRL pin to turn the device on and off.

This will produce an average output current proportional to the duty cycle of the control signal. In particular, a PWM signal with a max resolution of 10bit can be applied to the CTRL pin to change the output current to a value below the nominal average value set by resistor R_{SET} .

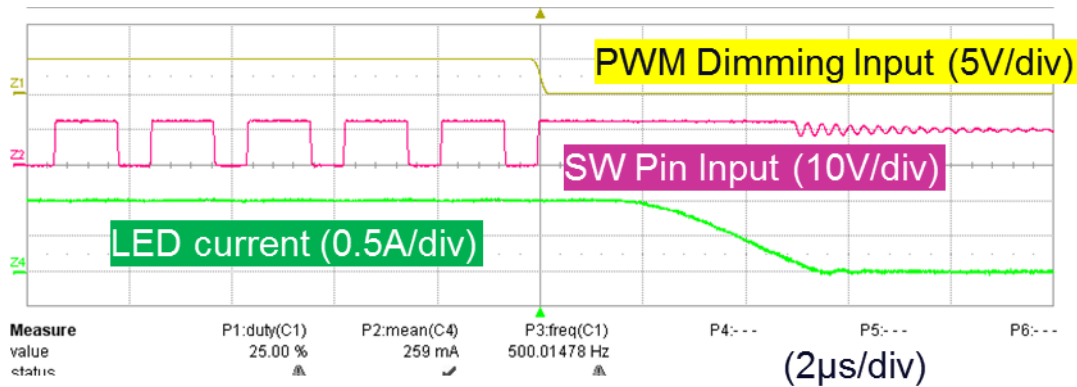

Figure 33 PWM Dimming waveforms ($f_{PWM} = 500\text{Hz}$, 25% Duty Cycle $f_{SW(NOM)} = 530\text{kHz}$)

While the PWM pin is high, the AL8807BQ switches as normal. When the PWM pin is brought low the output switch is turned off causing the SW pin to go high (one Schottky voltage drop above V_{IN}). It remains high (one Schottky voltage drop above V_{IN}) until the current through the inductor falls to zero. The time taken for the inductor current is dependent on the LED current, inductor value and LED chain voltage.

As the duty cycle gets smaller or PWM dimming frequency increases then fewer normal hysteretic switching cycles occur which will affect the overall average LED current.

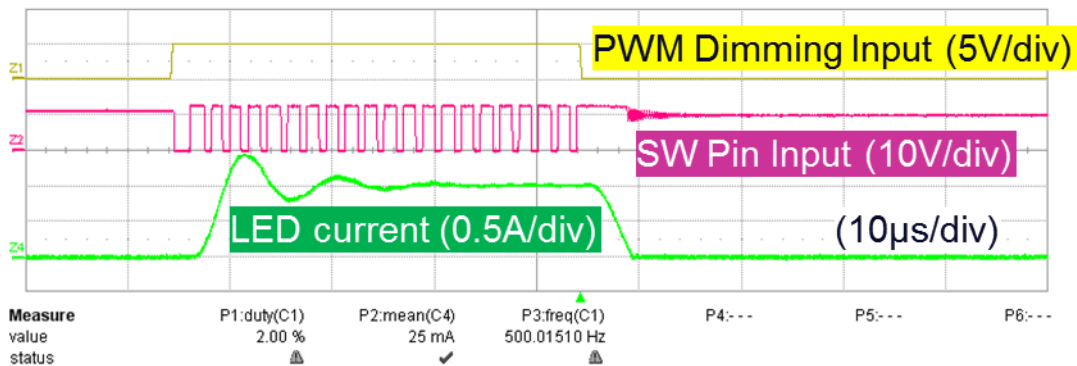

Figure 34 PWM Dimming waveforms ($f_{PWM} = 500\text{Hz}$, 2% Duty Cycle $f_{SW(NOM)} = 530\text{kHz}$)

To achieve high resolution the PWM frequency has to be much lower than the nominal switching frequency and the LED current output filter capacitor across the LEDs must not be used. The figures above have an LED current output filter present.

Applications Information (cont.)

Figures 35 and 36 show the PWM dimming performance of the AL8807BQ with a range of PWM frequencies with a nominal switching frequency of 530kHz.

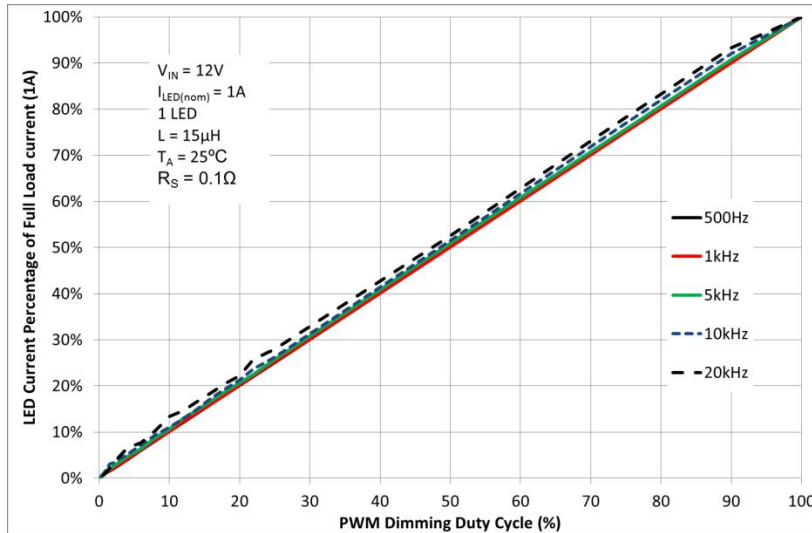

Figure 35 PWM Dimming at 530kHz nominal switching frequency

Looking at difference between duty cycle and percentage of full scale LED current yields a “Linearity Error”:

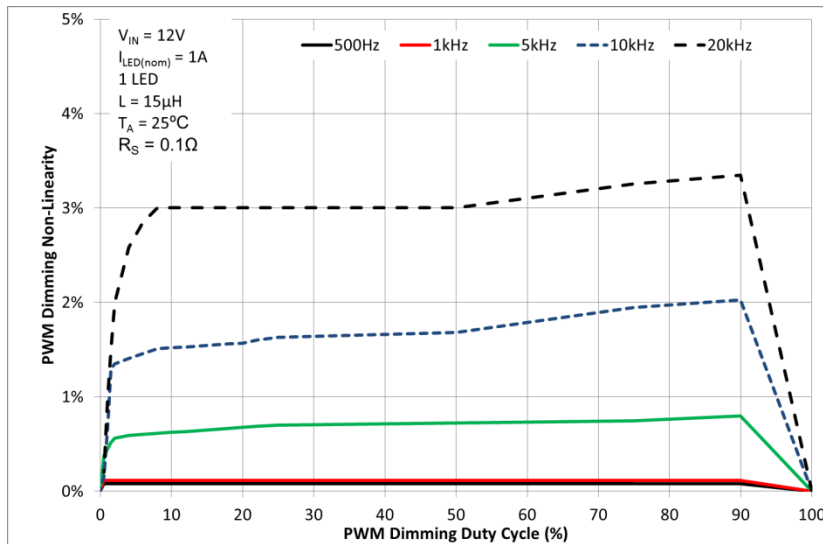

Figure 36 PWM Dimming Non-Linearity at 530kHz nominal switching frequency

The accuracy of the PWM dimming is affected by both the PWM frequency and also the switching frequency of the AL8807BQ. For best accuracy/resolution the switching frequency should be increased while the PWM frequency should be reduced.

The CTRL pin is designed to be driven by both 3.3V and 5V logic levels directly from a logic output with either an open drain output or push pull output stage.

Applications Information (cont.)

Reducing Output Ripple

Peak to peak ripple current in the LED(s) can be reduced, if required, by shunting a capacitor C2 across the LED(s) as shown already in the circuit schematic.

A value of 1 μ F will reduce the supply ripple current by a factor three (approx.). Proportionally lower ripple can be achieved with higher capacitor values. Note that the capacitor will not affect operating frequency or efficiency, but it will increase start-up delay, by reducing the rate of rise of LED voltage. By adding this capacitor the current waveform through the LED(s) changes from a triangular ramp to a more sinusoidal version without altering the mean current value.

Capacitor Selection

The small size of ceramic capacitors makes them ideal for AL8807BQ applications. X5R and X7R types are recommended because they retain their capacitance over wider voltage and temperature ranges than other types such as Z5U.

A 2.2 μ F input capacitor is sufficient for most intended applications of AL8807BQ; however a 4.7 μ F input capacitor is suggested for input voltages approaching 30V.

Diode Selection

For maximum efficiency and performance, the rectifier (D1) should be a fast low capacitance Schottky diode with low reverse leakage at the maximum operating voltage and temperature. The Schottky diode also provides better efficiency than silicon PN diodes, due to a combination of lower forward voltage and reduced recovery time.

It is important to select parts with a peak current rating above the peak coil current and a continuous current rating higher than the maximum output load current. In particular, it is recommended to have a diode voltage rating at least 15% higher than the operating voltage to ensure safe operation during the switching and a current rating at least 10% higher than the average diode current. The power rating is verified by calculating the power loss through the diode.

Schottky diodes, e.g. B240 or B140, with their low forward voltage drop and fast reverse recovery, are the ideal choice for AL8807BQ applications.

Inductor Selection

As the AL8807B is a hysteretic converter the switching frequency is dependent on inductor value and the potential difference between the LED chain voltage and input voltage. Higher values of inductance are recommended at higher supply voltages in order to minimize errors due to switching delays, which result in increased ripple and lower efficiency. Higher values of inductance also result in a smaller change in output current over the supply voltage range (See graphs). Based on this recommended inductor values for the AL8807BQ are in the range 33 μ H to 100 μ H.

To allow higher PWM dimming frequencies larger switching frequencies (see PWM dimming section) are required which necessitates the use smaller inductor values (for example down to 4.7 μ H).

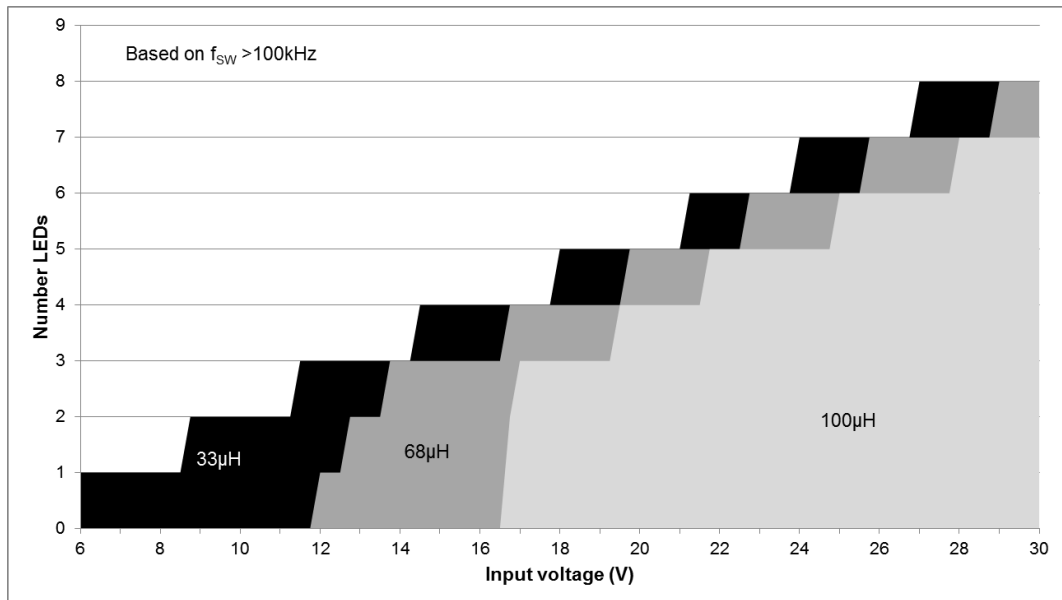

Figure 37 Inductor value with input voltage and number of LEDs

The inductor should be mounted as close to the device as possible with low resistance/stray inductance connections to the SW pin.

Applications Information (cont.)

Inductor Selection (cont.)

The chosen coil should have a saturation current higher than the peak output current and a continuous current rating above the required mean output current.

Suitable coils for use with the AL8807BQ are listed in the table below:

Part No.	L (μH)	DCR (V)	ISAT (A)	Manufacturer
MSS1038-333	33	0.093	2.3	CoilCraft www.coilcraft.com
MSS1038-683	68	0.213	1.5	
NPIS64D330MTRF	33	0.124	1.1	NIC www.niccomp.com

The inductor value should be chosen to maintain operating duty cycle and switch 'on'/off' times over the supply voltage and load current range.

The following equations can be used as a guide, with reference to Figure 38 – typical switching waveforms.

Switch 'On' time

$$t_{ON} = \frac{L\Delta I}{V_{IN} - V_{LED} - I_{AVG} \times (R_S + r_L + R_{SW})}$$

Switch 'Off' time

$$t_{OFF} = \frac{L\Delta I}{V_{LED} + V_D + I_{AVG} \times (R_S + r_L)}$$

Where:

- L is the coil inductance (H)
- r_L is the coil resistance (Ω)
- R_S is the current sense resistance (Ω)
- I_{avg} is the required LED current (A)
- ΔI is the coil peak-peak ripple current (A)
{Internally set to 0.3 x I_{avg}}
- V_{IN} is the supply voltage (V)
- V_{LED} is the total LED forward voltage (V)
- R_{SW} is the switch resistance (Ω) {=0.5Ω nominal}
- V_D is the diode forward voltage at the required load current (V)

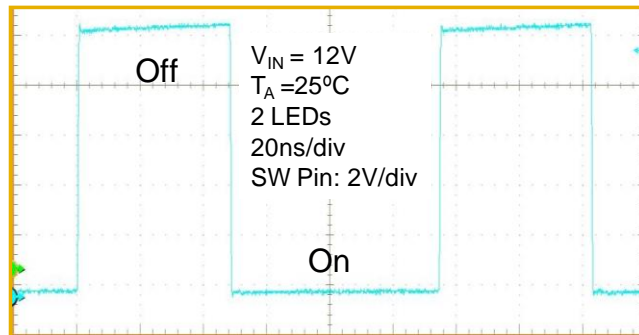

Figure 38 Typical Switching Waveform

Thermal Protection

The AL8807BQ includes Over-Temperature Protection (OTP) circuitry that will turn off the device if its junction temperature gets too high. This is to protect the device from excessive heat damage. The OTP circuitry includes thermal hysteresis that will cause the device to restart normal operation once its junction temperature has cooled down by approximately 55°C.

Thermal Considerations

For continuous conduction mode of operation, the absolute maximum junction temperature must not be exceeded. The maximum power dissipation depends on several factors: the thermal resistance of the IC package θ_{JA}, PCB layout, airflow surrounding the IC, and difference between junction and ambient temperature.

The maximum power dissipation can be calculated using the following formula:

$$P_{D(MAX)} = (T_{J(MAX)} - T_A) / \theta_{JA}$$

where

T_{J(MAX)} is the maximum operating junction temperature → Maximum recommended = 125°C

T_A is the ambient temperature, and

θ_{JA} is the junction to ambient thermal resistance.

θ_{JA}, is layout dependent and package dependent; the AL8807BQ's θ_{JA} on an FR4 51x51mm PCB with 2oz copper standing in still air is approximately 69°C/W.

So the maximum power dissipation at T_A = +25°C is:

$$P_{D(MAX)} = (125^\circ\text{C} - 25^\circ\text{C}) / (69^\circ\text{C/W}) = 1.41\text{W for the above dimensioned PCB}$$

Applications Information (cont.)

Figure 39, shows the power derating of the AL8807BQ on an FR4 51x51mm PCB with 2oz copper standing in still air. Changing the PCB dimensions, material, amount of metal associated with the thermal and other PCB components will change the AL8807BQ's junction-ambient thermal impedance.

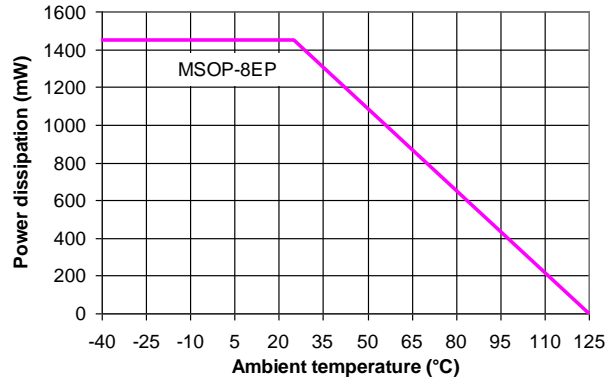

Figure 39 Derating Curve for Different PCB

Soft-Start

The AL8807BQ does not have in-built soft-start action; this can be seen in Figure 40.

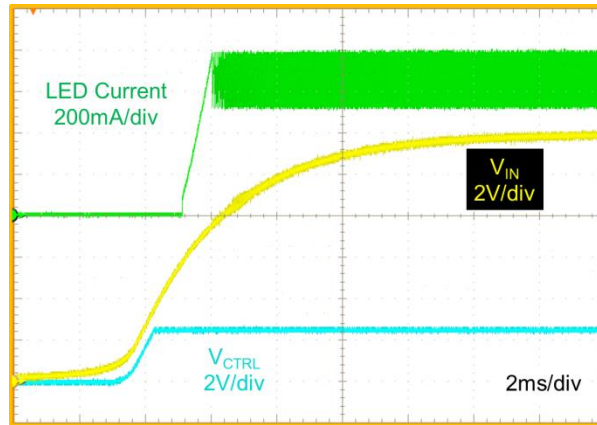

Figure 40 LED Current Start-up ($V_{IN} = 12V$, $I_{LED} = 667mA$, 2 LEDs)

At power-up V_{IN} rises exponentially, due to the bulk capacitor, the internal reference will reach 2.5V before V_{IN} reaches the Under-Voltage Lock-Out turn-on threshold at around 5.6V. This causes the CTRL pin voltage to rise and reaches 2.5V – 100% LED current - before the AL8807BQ fully turns on. When the AL8807BQ turns on, its output switch turns on causing the inductor current to increase until it reaches the upper threshold of the sense current level and the switching process begins.

As the CTRL pin only has PWM functionality, placing a capacitor on the CTRL pin will have no effect on the ramp-up of the LED current; the capacitor will just delay the ramp-up of the LED current and delay/extend the ramp-down of the LED current.

If some form of extra soft-start is required then the AL8806Q or AL8807Q should be considered.

Applications Information (cont.)

EMI and Layout Considerations

The AL8807BQ is a switching regulator with fast edges and measures small differential voltages; as a result of this care has to be taken with decoupling and layout of the PCB. To help with these effects the AL8807BQ has been developed to minimise radiated emissions by controlling the switching speeds of the internal power MOSFET. The rise and fall times are controlled to get the right compromise between power dissipation due to switching losses and radiated EMI. The turn-on edge (falling edge) dominates the radiated EMI which is due to an interaction between the Schottky diode (D1), Switching MOSFET and PCB tracks. After the Schottky diode reverse recovery time of around 5ns has occurred; the falling edge of the SW pin sees a resonant loop between the Schottky diode capacitance and the track inductance, L_{TRACK} , See Figure 41.

The tracks from the SW pin to the Anode of the Schottky diode, D1, and then from D1's cathode to the decoupling capacitors C1 should be as short as possible. There is an inductance internally in the AL8807BQ this can be assumed to be around 1nH. For PCB tracks a figure of 0.5nH per mm can be used to estimate the primary resonant frequency. If the track is capable of handling 1A increasing the thickness will have a minor effect on the inductance and length will dominate the size of the inductance. The resonant frequency of any oscillation is determined by the combined inductance in the track and the effective capacitance of the Schottky diode.

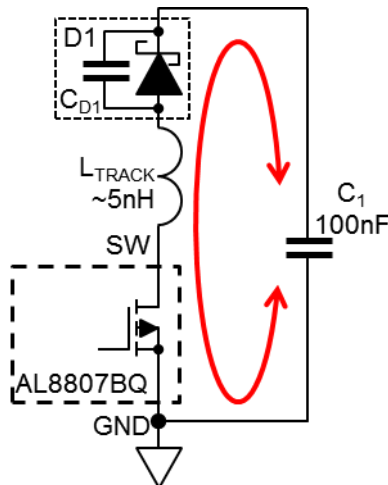

Figure 41 PCB Loop Resonance

Recommendations for minimising radiated EMI and other transients and thermal considerations are:

1. The decoupling capacitor (C1) has to be placed as close as possible to the V_{IN} pin and D1 Cathode
2. The freewheeling diode's (D1) anode, the SW pin and the inductor have to be placed as close as possible to each other to avoid ringing.
3. The Ground return path from C1 must be a low impedance path with the ground plane as large as possible
4. The LED current sense resistor (R1) has to be placed as close as possible to the V_{IN} and SET pins.
5. The majority of the conducted heat from the AL8807BQ is through the exposed pad underneath the MSOP-EP package. A maximum earth plane with thermal vias into a second earth plane will minimise self-heating
6. To reduce emissions via long leads on the supply input and LEDs low RF impedance capacitors (C2 and C5) should be used at the point the wires are joined to the PCB

Applications Information (cont.)

Fault Condition Operation

Open Circuit LEDs

The AL8807BQ has by default open LED protection. If the LEDs should become open circuit the AL8807BQ will stop oscillating; the SET pin will rise to V_{IN} and the SW pin will then fall to GND. No excessive voltages will be seen by the AL8807BQ.

LED Chain Shorted Together

If the LED chain should become shorted together (the anode of the top LED becomes shorted to the cathode of the bottom LED) the AL8807BQ will continue to switch and the current through the AL8807BQ's internal switch will still be at the expected current - so no excessive heat will be generated within the AL8807BQ. However, the duty cycle at which it operates will change dramatically and the switching frequency will most likely decrease. See Figure 43 for an example of this behavior at 24V input voltage driving 3 LEDs.

The on-time of the internal power MOSFET switch is significantly reduced because almost all of the input voltage is now developed across the inductor. The off-time is significantly increased because the reverse voltage across the inductor is now just the Schottky diode voltage (See Figure 43) causing a much slower decay in inductor current.

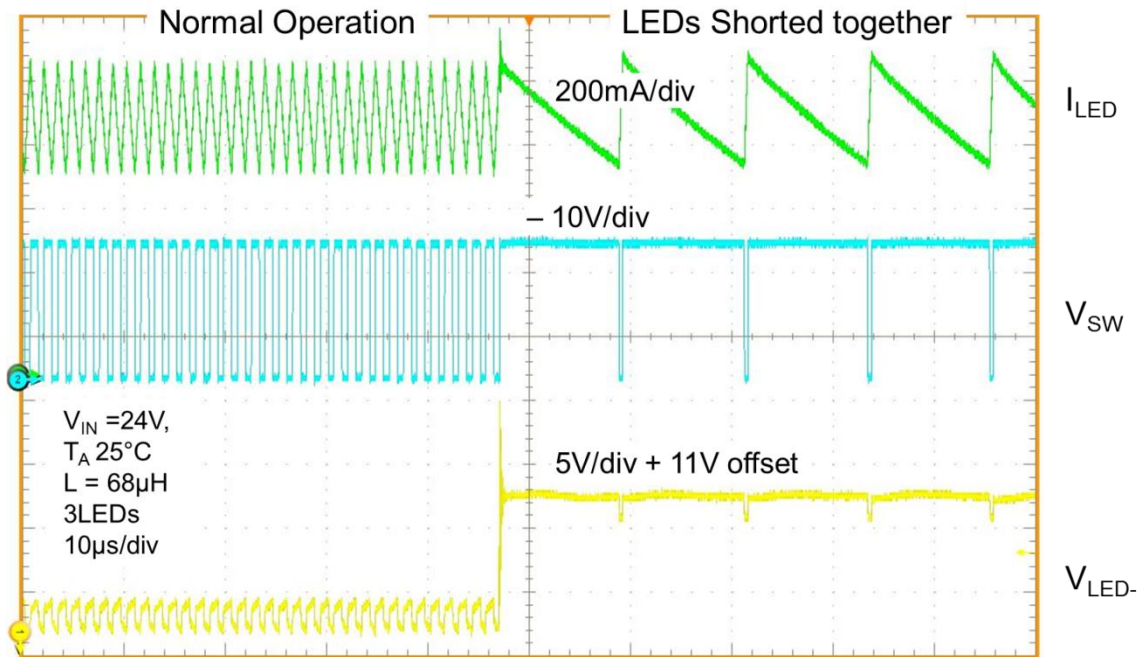

Figure 43 Switching Characteristics (normal operation to LED chain shorted out)

High Temperature Operation and Protection

The AL8807BQ is a high efficiency switching LED driver capable of operating junction temperatures up to +125°C. This allows it operate with ambient temperature in excess of 100°C given the correct thermal impedance to free air. If a fault should occur that leads to increased ambient temperatures and hence junction temperature then the Over-Temperature Protection (OTP) of the AL8807BQ will cut-in, turning the output of the AL8807BQ off. This will allow the junction temperature of the AL8807BQ to cool down and potentially giving an opportunity for the fault to clear itself.

The OTP shutdown junction temperature of the AL8807BQ is approximately +155°C with a hysteresis of +55°C. This means that the AL8807BQ will never switch-off with a junction temperature below +125°C allowing the designer to design the system thermally to fully utilize the wide operating junction temperature of the AL8807BQ.

Ordering Information

AL8807 B Q XX - XX

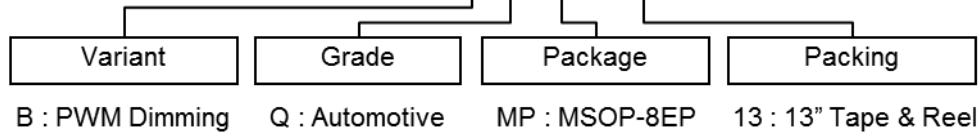

Part Number	Package Code	Packaging (Note 9)	Packing: 13" Tape and Reel			Qualification Grade (Note 10)
			Quantity	Tape Width	Part Number Suffix	
AL8807BQMP-13	MP	MSOP-8EP	2500	12mm	-13	Automotive Grade

- Note: 9. Pad layout as shown on Diodes Inc. suggested pad layout document AP02001, which can be found on our website at <http://www.diodes.com/datasheets/ap02001.pdf>
10. AL8807BQ have been qualified to AEC-Q100 grade 1 and is classified as "Automotive Grade" which supports PPAP documentation. See AL8807B datasheet for commercial qualified versions.

Marking Information

(1) MSOP-8EP

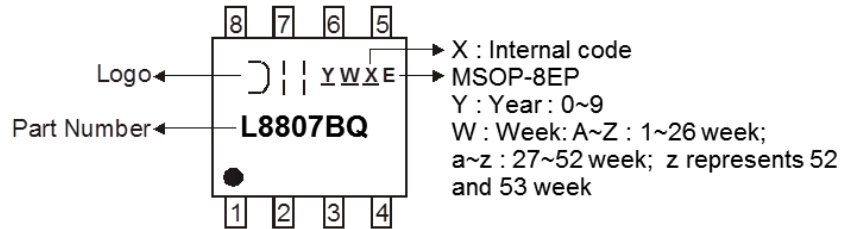

Part Number	Package
AL8807BQMP-13	MSOP-8EP

Package Outline Dimensions (All dimensions in mm.)

Please see AP02002 at <http://www.diodes.com/datasheets/ap02002.pdf> for latest version.

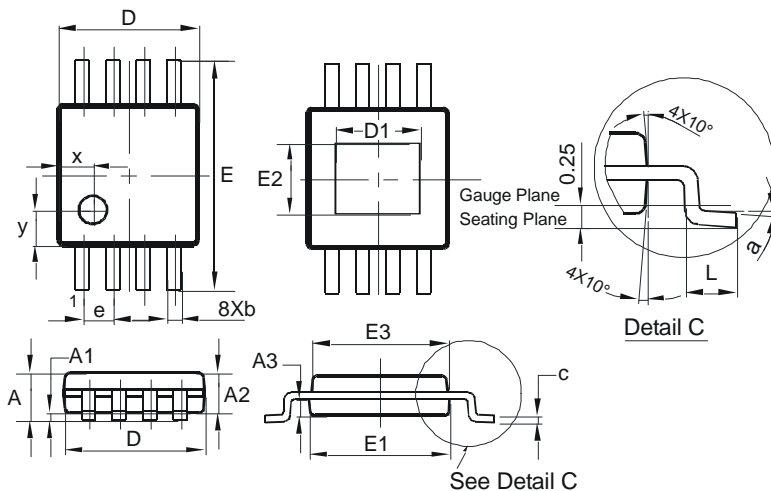

MSOP-8EP			
Dim	Min	Max	Typ
A	-	1.10	-
A1	0.05	0.15	0.10
A2	0.75	0.95	0.86
A3	0.29	0.49	0.39
b	0.22	0.38	0.30
c	0.08	0.23	0.15
D	2.90	3.10	3.00
D1	1.60	2.00	1.80
E	4.70	5.10	4.90
E1	2.90	3.10	3.00
E2	1.30	1.70	1.50
E3	2.85	3.05	2.95
e	-	-	0.65
L	0.40	0.80	0.60
a	0°	8°	4°
x	-	-	0.750
y	-	-	0.750
All Dimensions in mm			

Suggested Pad Layout

Please see AP02001 at <http://www.diodes.com/datasheets/ap02001.pdf> for the latest version.

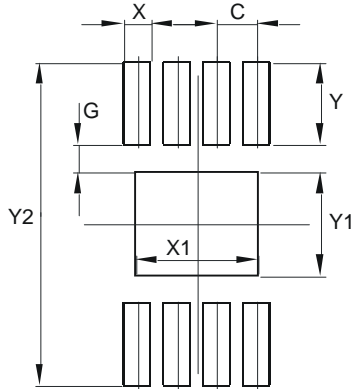

Dimensions	Value (in mm)
C	0.650
G	0.450
X	0.450
X1	2.000
Y	1.350
Y1	1.700
Y2	5.300

IMPORTANT NOTICE

DIODES INCORPORATED MAKES NO WARRANTY OF ANY KIND, EXPRESS OR IMPLIED, WITH REGARDS TO THIS DOCUMENT, INCLUDING, BUT NOT LIMITED TO, THE IMPLIED WARRANTIES OF MERCHANTABILITY AND FITNESS FOR A PARTICULAR PURPOSE (AND THEIR EQUIVALENTS UNDER THE LAWS OF ANY JURISDICTION).

Diodes Incorporated and its subsidiaries reserve the right to make modifications, enhancements, improvements, corrections or other changes without further notice to this document and any product described herein. Diodes Incorporated does not assume any liability arising out of the application or use of this document or any product described herein; neither does Diodes Incorporated convey any license under its patent or trademark rights, nor the rights of others. Any Customer or user of this document or products described herein in such applications shall assume all risks of such use and will agree to hold Diodes Incorporated and all the companies whose products are represented on Diodes Incorporated website, harmless against all damages.

Diodes Incorporated does not warrant or accept any liability whatsoever in respect of any products purchased through unauthorized sales channel. Should Customers purchase or use Diodes Incorporated products for any unintended or unauthorized application, Customers shall indemnify and hold Diodes Incorporated and its representatives harmless against all claims, damages, expenses, and attorney fees arising out of, directly or indirectly, any claim of personal injury or death associated with such unintended or unauthorized application.

Products described herein may be covered by one or more United States, international or foreign patents pending. Product names and markings noted herein may also be covered by one or more United States, international or foreign trademarks.

This document is written in English but may be translated into multiple languages for reference. Only the English version of this document is the final and determinative format released by Diodes Incorporated.

LIFE SUPPORT

Diodes Incorporated products are specifically not authorized for use as critical components in life support devices or systems without the express written approval of the Chief Executive Officer of Diodes Incorporated. As used herein:

A. Life support devices or systems are devices or systems which:

1. are intended to implant into the body, or
2. support or sustain life and whose failure to perform when properly used in accordance with instructions for use provided in the labeling can be reasonably expected to result in significant injury to the user.

B. A critical component is any component in a life support device or system whose failure to perform can be reasonably expected to cause the failure of the life support device or to affect its safety or effectiveness.

Customers represent that they have all necessary expertise in the safety and regulatory ramifications of their life support devices or systems, and acknowledge and agree that they are solely responsible for all legal, regulatory and safety-related requirements concerning their products and any use of Diodes Incorporated products in such safety-critical, life support devices or systems, notwithstanding any devices- or systems-related information or support that may be provided by Diodes Incorporated. Further, Customers must fully indemnify Diodes Incorporated and its representatives against any damages arising out of the use of Diodes Incorporated products in such safety-critical, life support devices or systems.

Copyright © 2014, Diodes Incorporated

www.diodes.com