

High Input Voltage, Low Quiescent Current LDO

Descriptions

The WL2852K series is a high accuracy, high input voltage low quiescent current, high speed, low dropout Linear regulator with high ripple rejection. The device is manufactured with BiCMOS process.

The WL2852K offers over-current limit and over temperature protection to ensure the device working in well conditions.

The WL2852K regulators are available in standard SOT-89-3L packages. Standard products are Pb-free and Halogen-free.

Features

- Supply Voltage : 4.75V~30V
- Output Range : 1.8V~5.0V
- Output Accuracy : <+/-2%
- Output Current : 100mA (Up to 150mA Typ.)
- PSRR : 60dB @ 100Hz
- Dropout Voltage : 800mV @ I_{OUT}=100mA
- Quiescent Current : 10μA@V_{IN}=7V(Typ.)
- Recommend Capacitor : 10uF



SOT-89

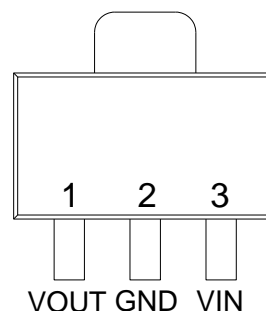

Pin Configuration (Top View)

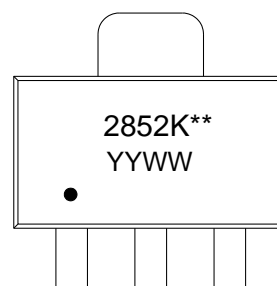

For detail marking information, please see page 9.

Marking

Order Information

For detail order information, please see page 9.

Typical Application

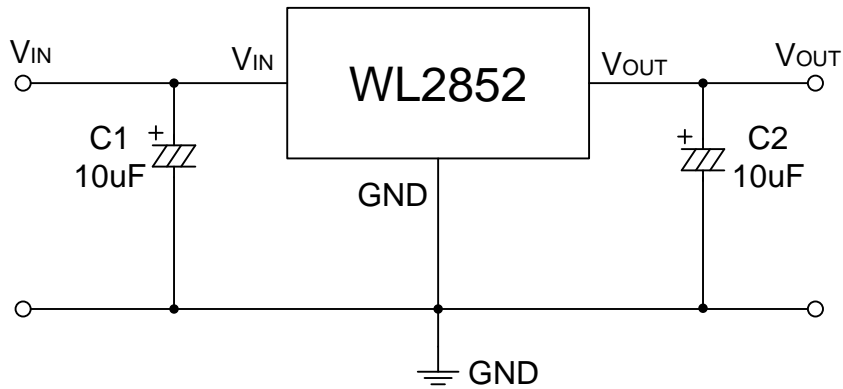

Pin Description

PIN	Symbol	Description
1	VOUT	Voltage Output
2	GND	Ground
3	VIN	Voltage Input

Block Diagram

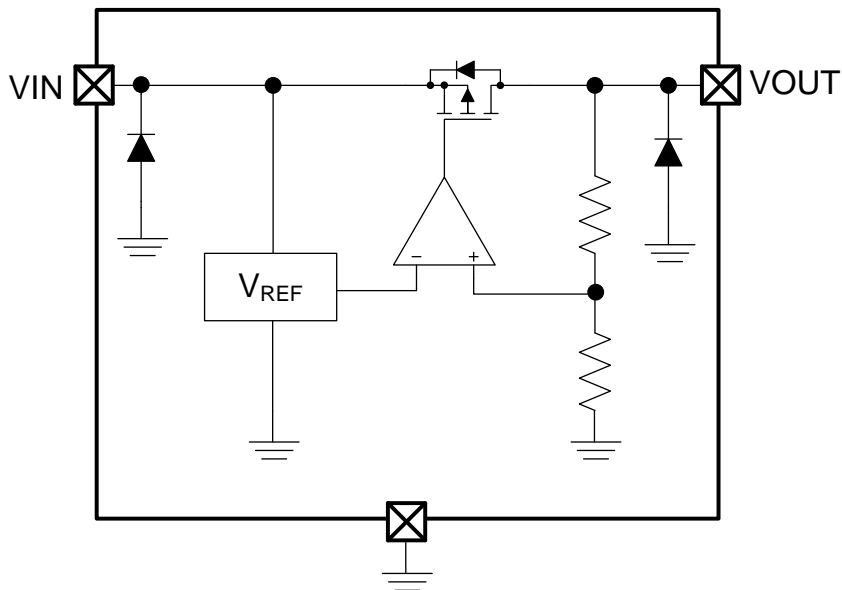

Absolute Maximum Ratings

Parameter	Value	Unit
Power Dissipation	Internal limited	mW
V _{IN} Range	-0.3 ~ 45	V
V _{OUT} Range	-0.3 ~ 6.5	V
Lead Temperature Range	260	°C
Storage Temperature Range	-55 ~ 150	°C
Operating Junction Temperature Range	150	°C
ESD MM	400	V
ESD HBM	4K	V

Recommend Operating Ratings

Parameter	Value	Unit
Operating Supply voltage	4.75 ~ 30	V
Operating Temperature Range	-40 ~ 85	°C
Thermal Resistance, R _{θJA}	250	°C/W

Electronics Characteristics (Ta=25°C, V_{IN}=12V, C_{IN}=C_{OUT}=10uF, unless otherwise noted)

Symbol	Parameter	Test Condition	WL2852K SPEC			Unit
			Min.	Typ.	Max.	
V _{IN}	Input Range	I _{OUT} =10mA	4.75		30	V
V _{OUT}	Output Range	I _{OUT} =10mA	V _{OUT} *0.98	V _{OUT}	V _{OUT} *1.02	V
ΔV _{OUT}	Output Voltage	V _{IN} =12V, I _{OUT} =10mA	4.9	5.0	5.1	V
			3.234	3.3	3.366	V
I _{OUT_PK}	Maximum Output Current	V _{IN} =12V, R _L =1Ω	180	280	460	mA
I _Q	Quiescent Current	V _{IN} =7V, No load		10	15	μA
		V _{IN} =24V, No load		11	16	
		V _{IN} =40V, No load		13	20	
V _{DROP}	Dropout Voltage	I _{OUT} =1mA		8	12	mV
		I _{OUT} =100mA		800	1200	
ΔV _{Line}	Line Regulation	V _{IN} =7--24V, V _{OUT} =5V I _{OUT} =1mA		0.02		%V
		V _{IN} =7--45V, V _{OUT} =5V I _{OUT} =1mA		0.1		
ΔV _{Load}	Load Regulation	V _{IN} =12V, I _{OUT} =1--100mA		0.6		%
e _{NO}	Output Noise	I _{OUT} =10mA	-100		+100	μV
PSRR	Ripple Rejection	V _{IN} =10V V _{PP} =0.5V I _{OUT} =1mA	f=100Hz	60		dB
			f=1KHz	45		
			f=10KHz	35		
T _{SD}	Thermal Protection	V _{IN} =12V, I _{OUT} =1mA		165		°C
T _{SD_HYS}	Thermal Protection Hys	V _{IN} =12V, I _{OUT} =1mA		30		°C
ΔVo/ΔT	Temperature Coefficient	V _{IN} =12V, I _{OUT} =1mA		±0.5		mv/°C

Typical characteristics (Ta=25oC, CIN=COUT=10uF, unless otherwise noted)

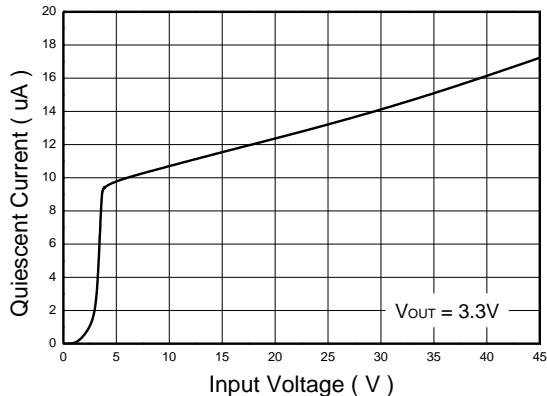

Quiescent Current vs. Input Voltage

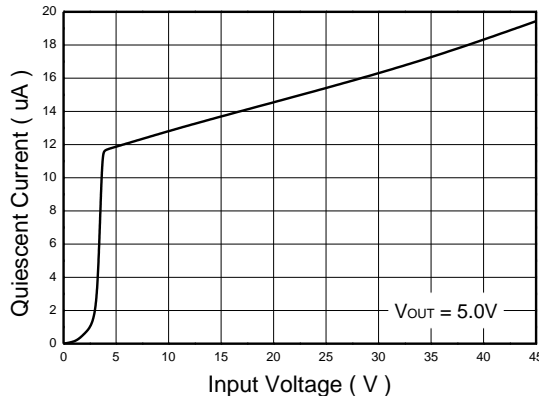

Quiescent Current vs. Input Voltage

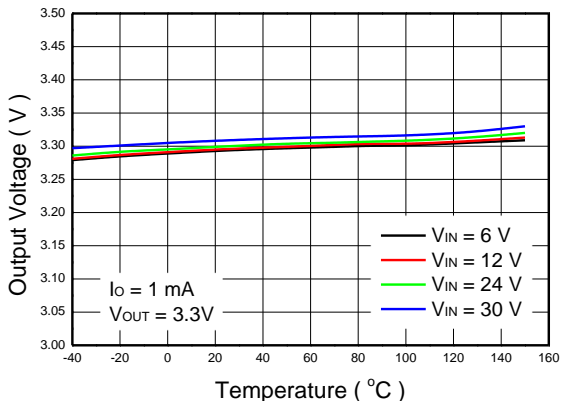

Output Voltage vs. Temperature

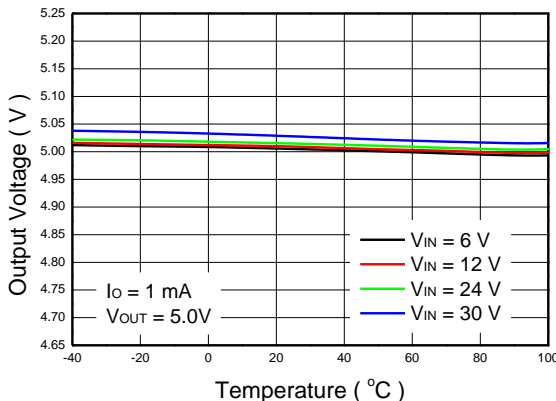

Output Voltage vs. Temperature

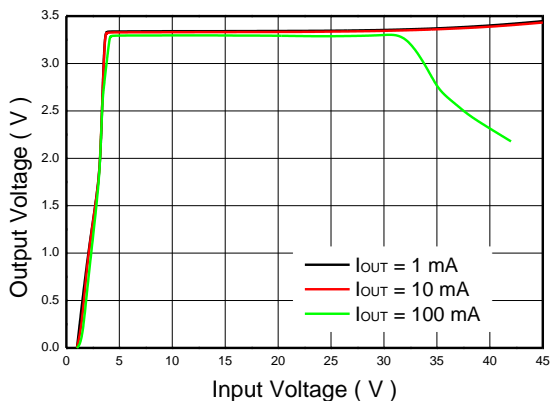

Output Voltage vs. Input Voltage

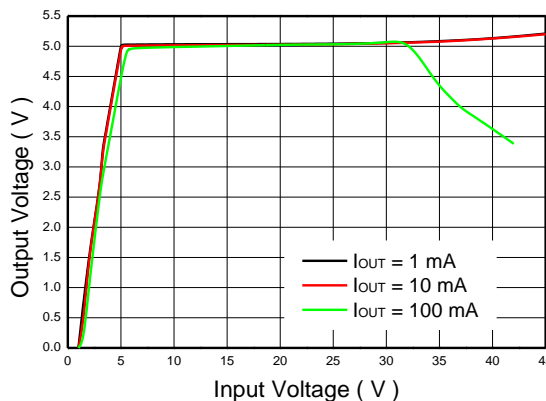

Output Voltage vs. Input Voltage

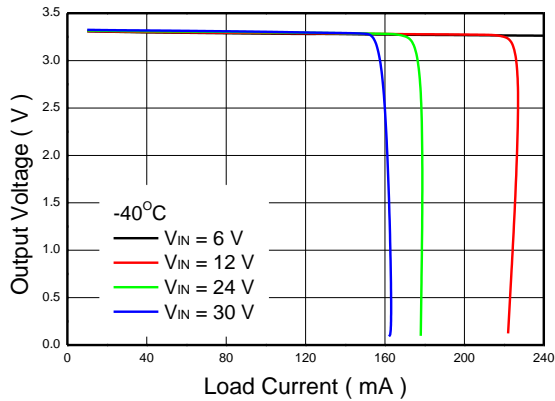

Output Voltage vs. Load Current

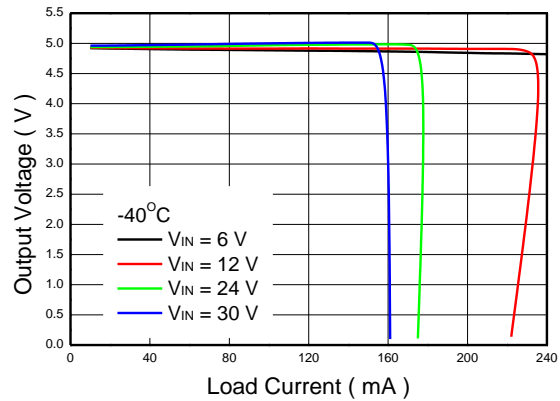

Output Voltage vs. Load Current

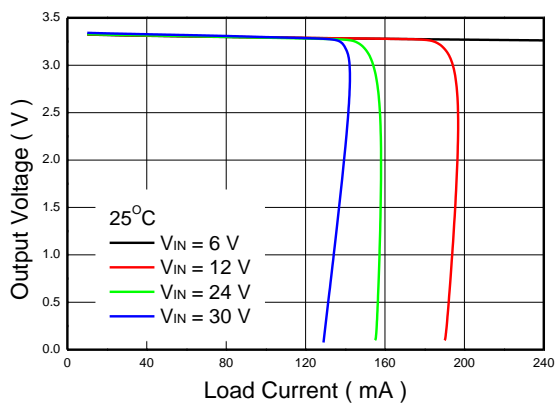

Output Voltage vs. Load Current

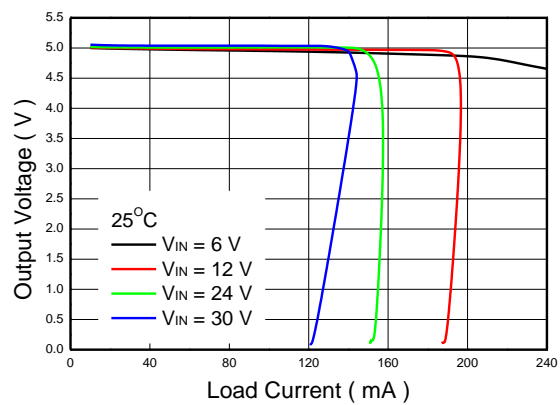

Output Voltage vs. Load Current

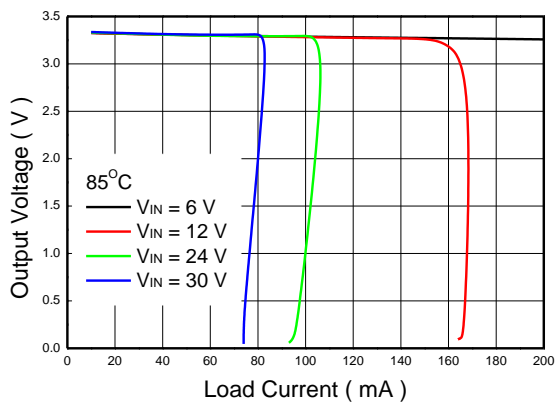

Output Voltage vs. Load Current

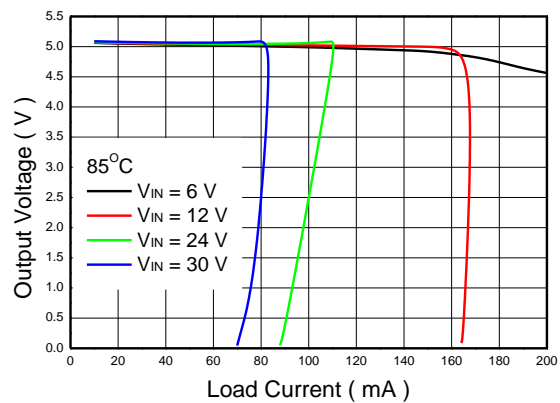

Output Voltage vs. Load Current

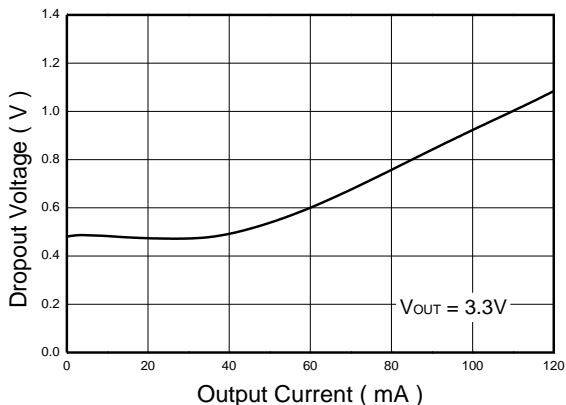

Dropout Voltage vs. Output Current

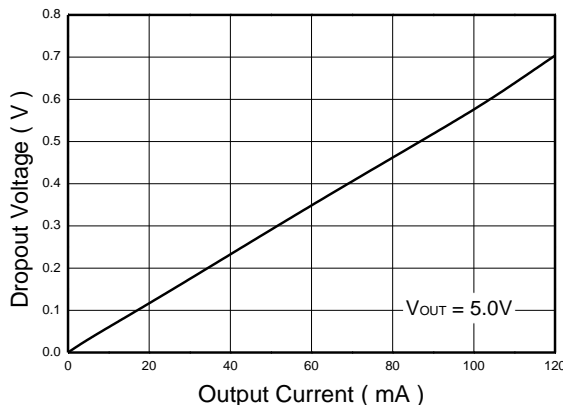

Dropout Voltage vs. Output Current

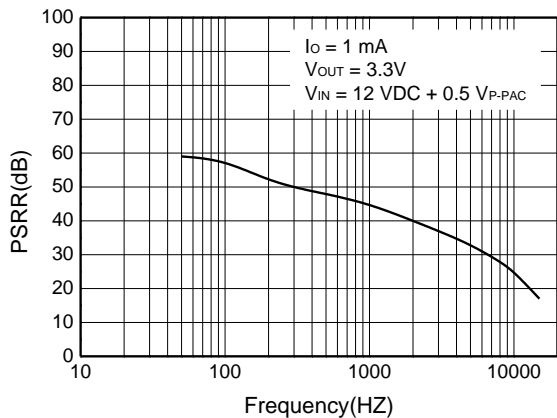

PSRR vs. Frequency

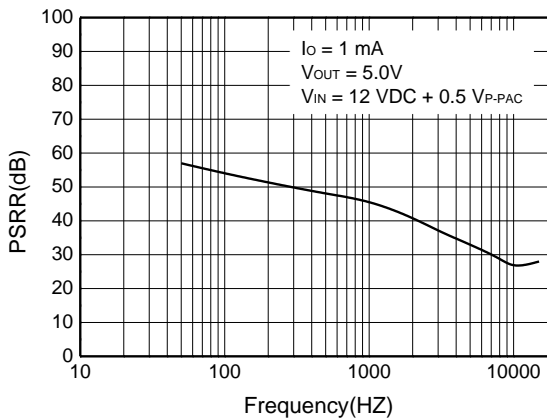

PSRR vs. Frequency

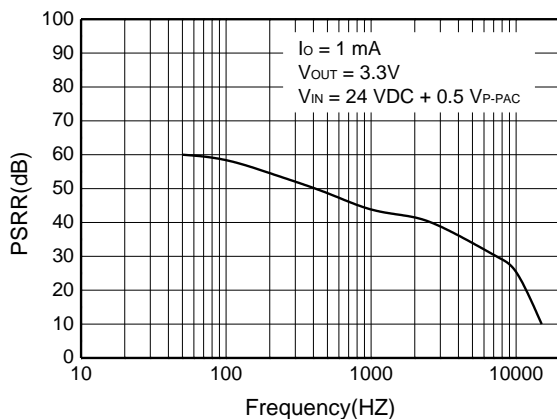

PSRR vs. Frequency

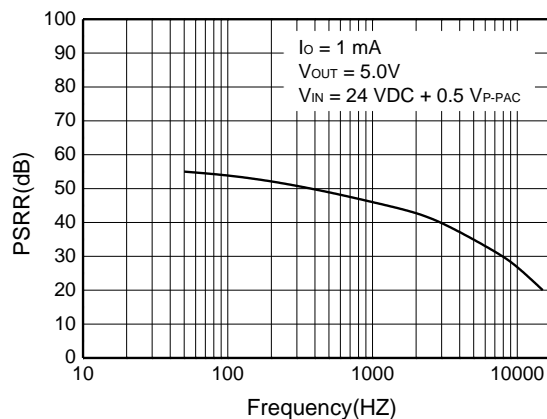

PSRR vs. Frequency

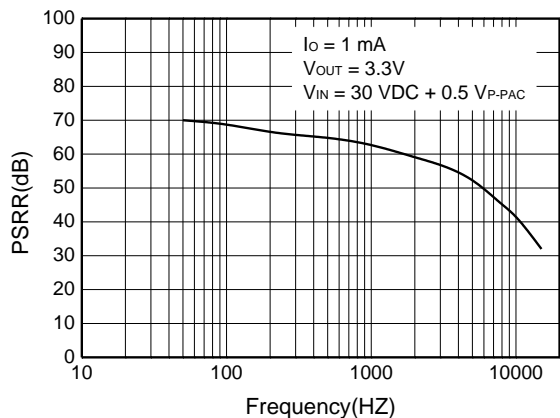

PSRR vs. Frequency

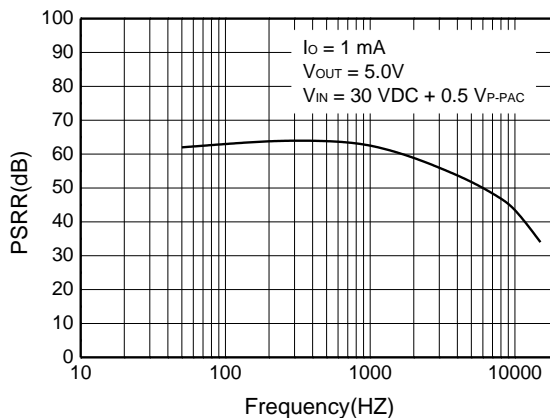

PSRR vs. Frequency

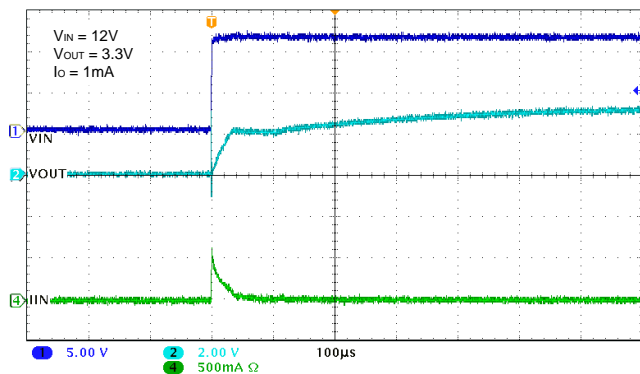

Startup from Power ON

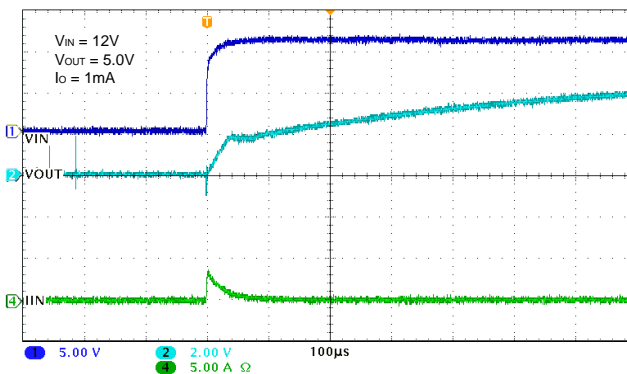

Startup from Power ON

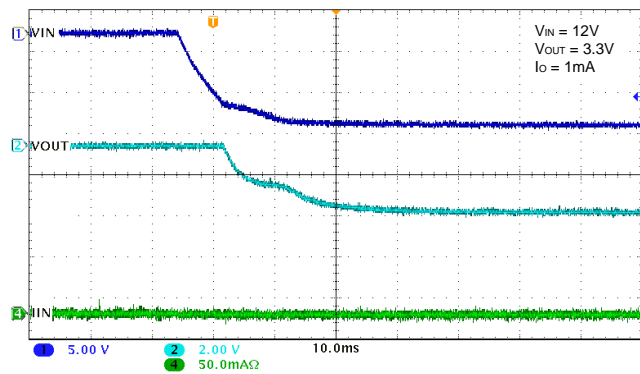

Shutdown from Power OFF

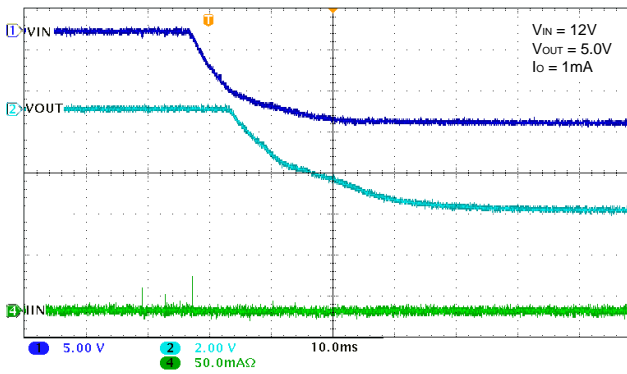

Shutdown from Power OFF

ORDER INFORMATION

Ordering No.	Vout (V)	Package	Operating Temperature	Marking	Shipping
WL2852K33-3/TR	3.3	SOT-89	-40~+85°C	2852KDD YYWW	Tape and Reel, 3000
WL2852K50-3/TR	5.0	SOT-89	-40~+85°C	2852KFA YYWW	Tape and Reel, 3000

Marking:

2852K** = Device Code

YY = Year

WW = Week

Package outline dimensions

SOT-89-3L

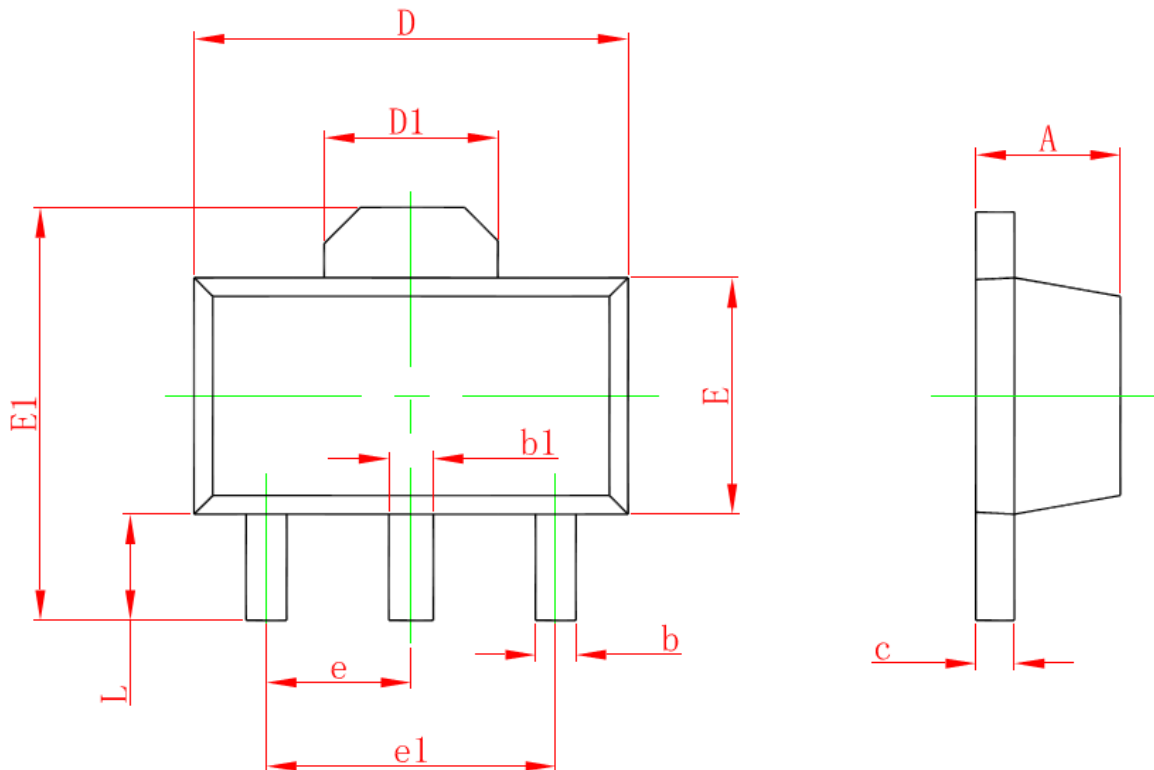

Symbol	Dimensions in millimeter		
	Min.	Typ.	Max.
A	1.400	1.500	1.600
b	0.320	0.420	0.520
b1	0.400	0.490	0.580
c	0.350	-	0.440
D	4.400	4.500	4.600
D1	1.550 Ref.		
E	2.300	2.450	2.600
E1	3.940	4.100	4.250
e	1.500 Typ.		
e1	3.000 Typ.		
L	0.900	-	1.200