

AMGP-6434

28-31 GHz 4W SMT Packaged Power Amplifier

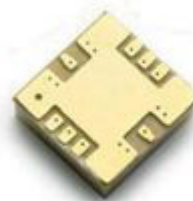

Data Sheet



Description

The AMGP-6434 is a surface mount packaged 4-Watt power amplifier that operates from frequencies between 28 to 31 GHz. In the operational frequency band from 29.5 to 30 GHz, it provides 35.5 dBm of typical output power (P_{1dB})/36 dBm P_{sat} and 19 dB of small-signal gain. This PA is also suitable for high linear application where the PA demonstrates greater than -40 dBc of third order output inter modulation (OIM3) at +20 dBm/tone output power level.

Features

- 5 x 5 mm surface mount package
- High +36 dBm Output Power from 28 to 31 GHz
- 50 Ω input and output match
- -40° C to +85° C operation

Functional Block Diagram

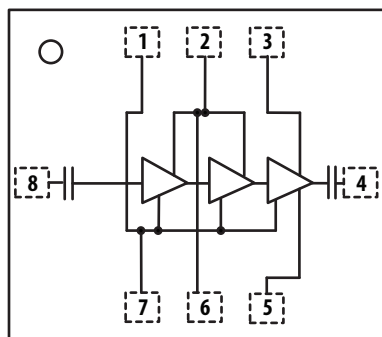

Pin	Function
1	Vg
2	Vd1
3	Vd2
4	RF_OUT
5	Vd2
6	Vd1
7	Vg
8	RF_IN

Applications

- VSAT
- Microwave Radio System
- Satellite Up/Down Link

Note: This part is not rated for high-moisture environments.

Package Diagram

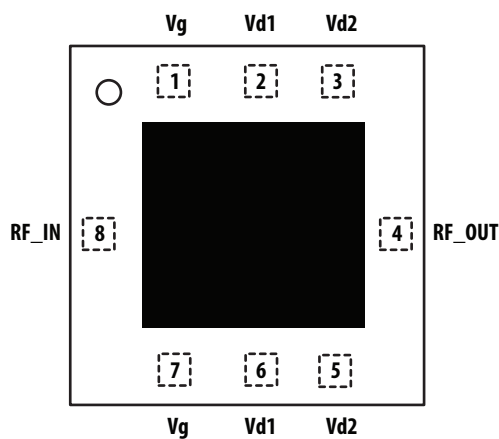

Attention: Observe Precautions for handling electrostatic sensitive devices.
 ESD Machine Model (Class A): 50 V
 ESD Human Body Model (Class 1A): 250 V
 Refer to Avago Application Note A004R: Electrostatic Discharge Damage and Control.

ELECTRICAL SPECIFICATIONS

Table 1. Absolute Minimum and Maximum [1] Ratings

Parameter		Specifications			Comments
Description	Pin	Min.	Max.	Unit	
Drain Supply Voltage	V _{d1} V _{d2}		6.5	V	
Gate Supply Voltage	V _g	-2	0	V	
RF Input Power (P _{in}) [2]	RFIN		24	dBm	CW
Power Dissipation (P _{diss})			20	W	$P_{diss} = V_{d1} \times I_{d1} + V_{d2} \times I_{d2} + P_{in} - P_{out}$
MSL			MSL2		
T _{CH}			150	°C	Channel Temperature
T _{STG}		-65	150	°C	Storage Temperature

Notes:

1. Operation of this device above any one of these maximum parameters may cause permanent damage
2. With the DC (typical bias) and RF applied to the device at board temperature T_b = 25° C

Table 2. Recommended Operating Range

Parameter		Specifications				Comments
Description	Pin	Min.	Typical	Max.	Unit	Comments
Drain Supply Voltage	V _{d1} V _{d2}		6.0		V	
Gate Supply Voltage	V _g	-1	-0.68	-0.35	V	
Gate Current @ 17dBm Pin	I _g			1.2	mA	
Gate Current @ SS [-20dBm Pin]	I _g			650	uA	
Quiescent Drain Supply Current (I _{dq})	V _{d1} V _{d2}		600 800		mA	$I_{dq} = I_{d1} + I_{d2}$
RF Output Power (P _{out})	RFOUT		36		dBm	CW
Frequency Range		28		31	GHz	
Thermal Resistance, θ _{ch-b}			4.5		°C/W	Channel to board
Base Plate Temperature		-40		+85	°C	

Electrical Specifications

All data measured on a 2.4 mm connectorized production contactor board (Rogers 4350B) at $V_{dd1} = V_{dd2} = 6\text{ V}$, $I_{dd} = 3\text{ A}$ ($I_{dd1} + I_{dd2}$), $T_c = 25^\circ\text{ C}$, and $50\ \Omega$ at all ports unless otherwise stated

Table 3. RF Electrical Characteristics

Parameter	Performance			Unit	Comments
	Min.	Typical	Max.		
Frequency Range (GHz)	28		31	GHz	
Input Return Loss (dB)		-8		dB	Small Signal
Output Return Loss (dB)		-10		dB	Small Signal
Gain (dB) ^[1] @ Freq = 29.5 GHz	21	23.3	27	dB	$V_{dd} = 6\text{ V}$, $I_{dd} = 3\text{ A}$
($P_{in} = -20\text{ dBm}$) @ Freq = 30 GHz	21	22.1	27		$V_{dd} = 6\text{ V}$, $I_{dd} = 3\text{ A}$
Reverse Isolation (dB)		-40		dB	Small Signal
P_{out} ^[1] @ Freq = 29.5 GHz	35.25	37.3		dBm	$V_{dd} = 6\text{ V}$, $I_{dd} = 3\text{ A}$
($P_{in} = 17\text{ dBm}$) @ Freq = 30 GHz	35.25	36.1			$V_{dd} = 6\text{ V}$, $I_{dd} = 3\text{ A}$
P_{1dB} @ Freq = 29.5 GHz		35.8		dBm	$V_{dd} = 6\text{ V}$, $I_{dq} = 1.4\text{ A}$
@ Freq = 30 GHz		35.3			$V_{dd} = 6\text{ V}$, $I_{dq} = 1.4\text{ A}$
IM3 Level		-40		dBc	$\Delta f = 20\text{ MHz}$, $P_{out} = 20\text{ dBm/ tone}$
Total Drain Current		3		A	I_{dd}

Note:

1. P_{out} and Gain measurement accuracy is subjected to the tolerance of $\pm 0.5\text{ dBm}$ respectively.

Product Consistency Distribution Charts at 29.5 GHz and 30 GHz, $V_{dd} = 6\text{ V}$, $I_{dq} = 3\text{ A}$

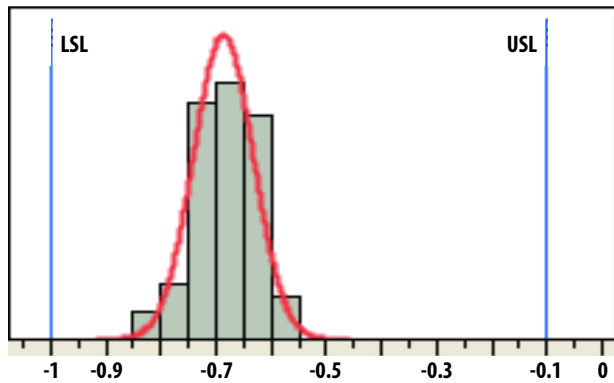

V_g @ $V_{dd} = 6\text{ V}$, $I_{dq} = 3\text{ A}$ ($P_{in} = 17\text{ dBm}$), Mean = -0.68 V , LSL = -1 V , USL = -0.1 V

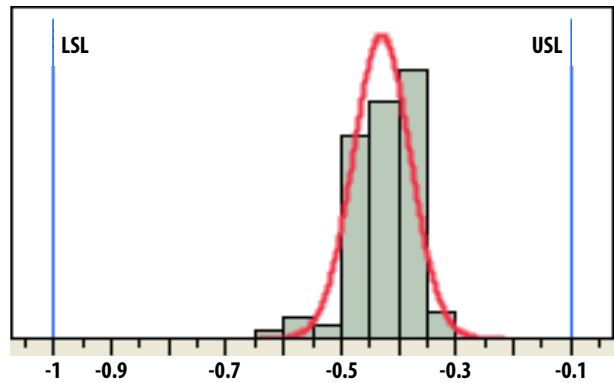

V_g @ $V_{dd} = 6\text{ V}$, $I_{dq} = 3\text{ A}$ ($P_{in} = -20\text{ dBm}$), Mean = -0.42 V , LSL = -1 V , USL = -0.1 V

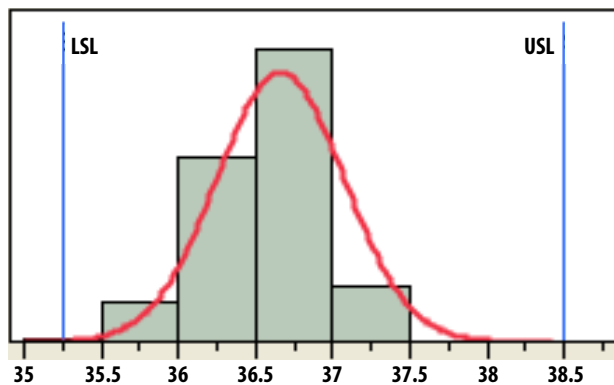

P_{out} @ 29.5 GHz ($P_{in} = 17\text{ dBm}$), Mean = 36.83 dBm , LSL = 35.25 dBm , USL = 38.5 dBm

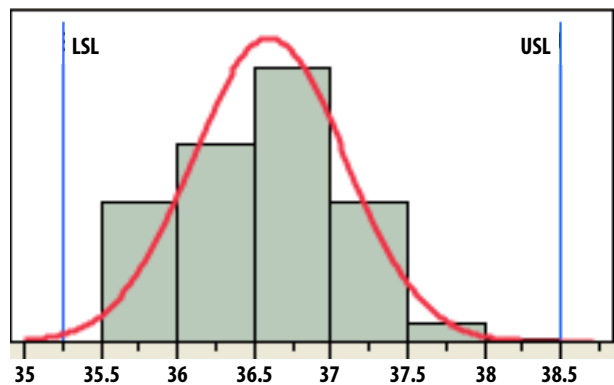

P_{out} @ 30 GHz ($P_{in} = 17\text{ dBm}$), Mean = 36.51 dBm , LSL = 35.25 dBm , USL = 38.5 dBm

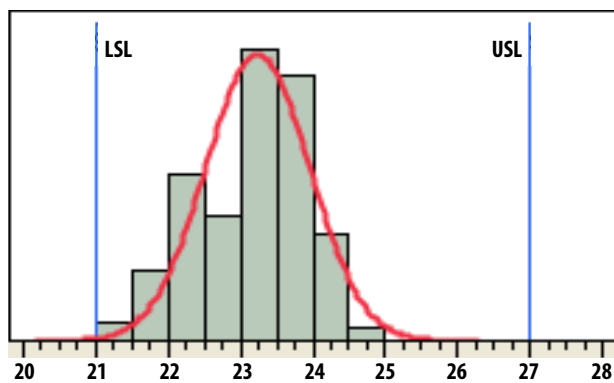

Gain @ 29.5 GHz ($P_{in} = -20\text{ dBm}$), Mean = 23.37 dB , LSL = 21 dB , USL = 27 dB

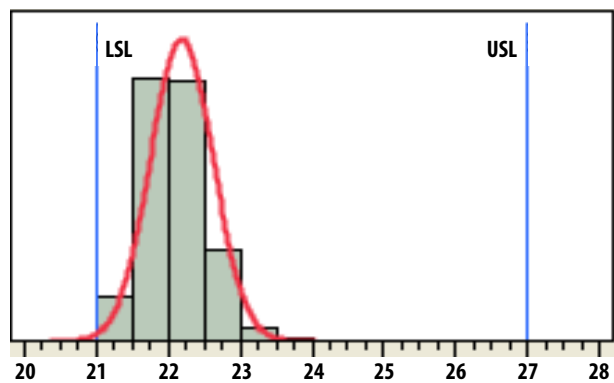

Gain @ 30 GHz ($P_{in} = -20\text{ dBm}$), Mean = 22.09 dB , LSL = 21 dB , USL = 27 dB

Selected Performance Plots

All data measured on a 2.4 mm connector based evaluation board at $V_{dd1} = V_{dd2} = 6\text{ V}$, $I_{dq} = 1.4\text{ A}$ ($I_{d1} + I_{d2}$), $T_A = 25^\circ\text{ C}$, and $50\ \Omega$ at all ports.

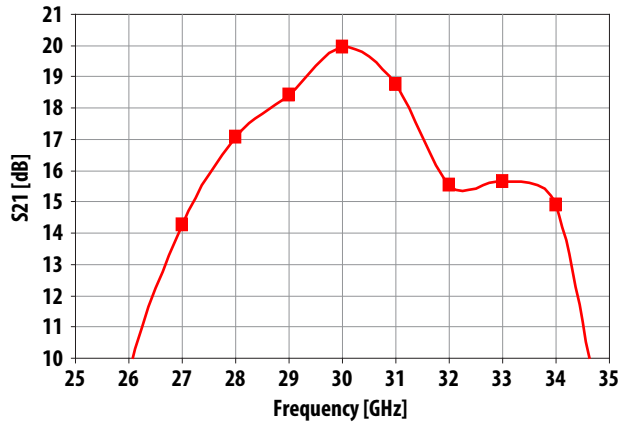

Figure 1. S₂₁ (dB) Frequency Sweep

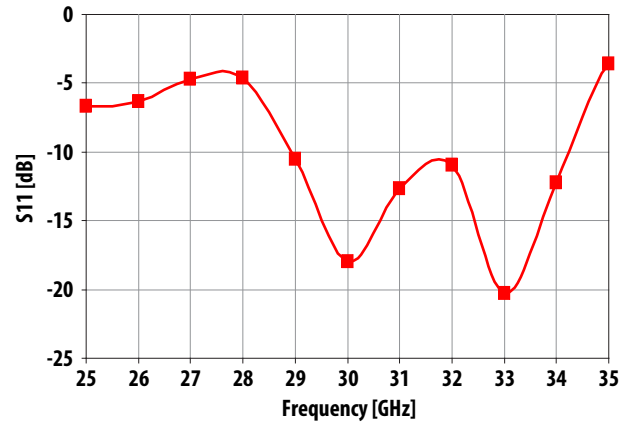

Figure 2. S₁₁ (dB) Frequency Sweep

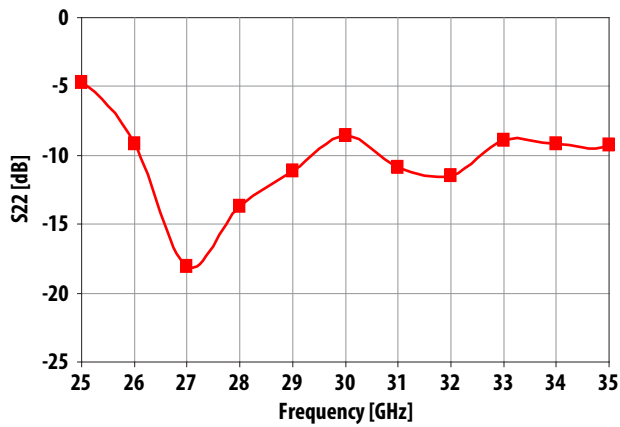

Figure 3. S₂₂ (dB) Frequency Sweep

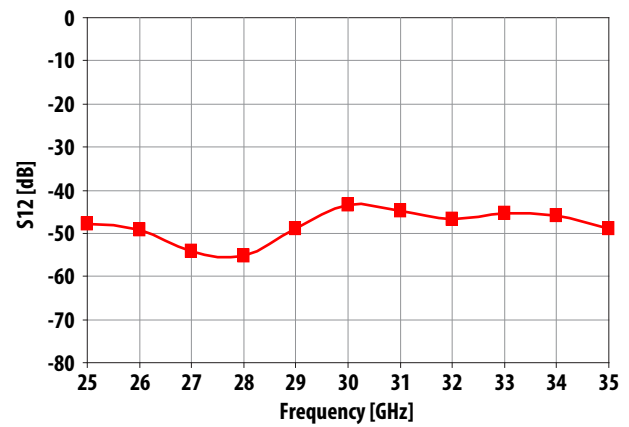

Figure 4. S₁₂ (dB) Frequency Sweep

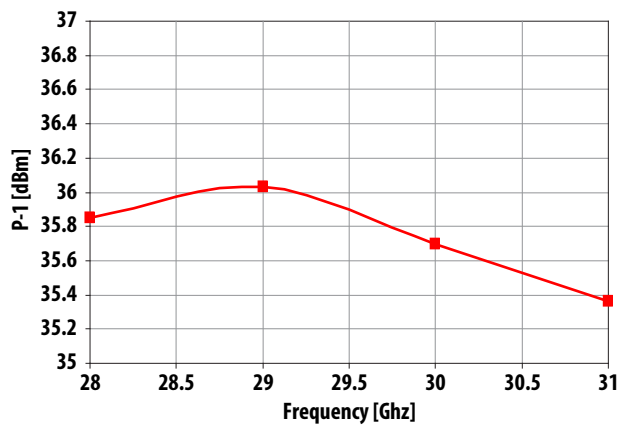

Figure 5. P_{1dB} (dBm) Frequency Sweep

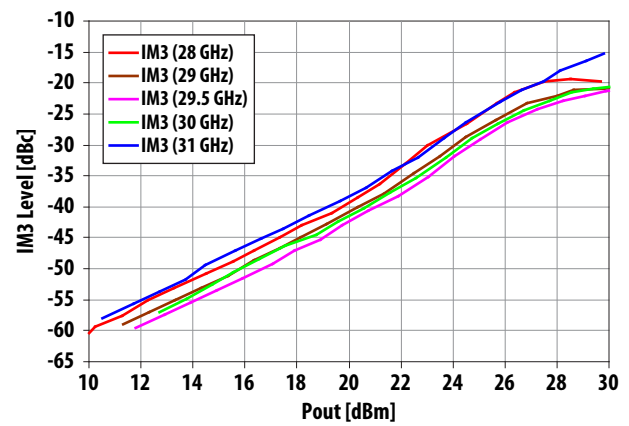

Figure 6. IM3 level (dBc) vs. Output power/tone

Selected Performance Plots over Operating Temperature Range

All data measured on a 2.4 mm connector based evaluation board at $V_{dd1} = V_{dd2} = 6\text{ V}$, $I_{dq} = 1.4\text{ A}$ ($I_{d1} + I_{d2}$), and $50\ \Omega$ at all ports. I_{dq} has been maintained at 1.4 A under different temperature conditions.

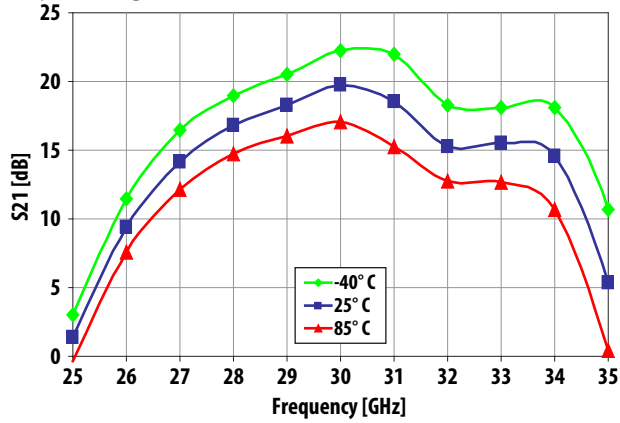

Figure 7. S_{21} (dB) Frequency Sweep over Temperature

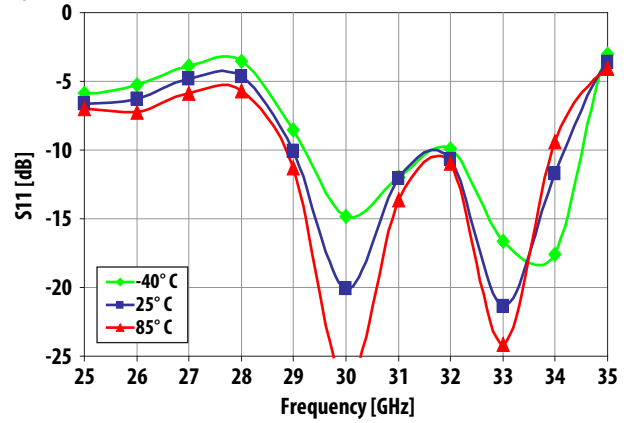

Figure 8. S_{11} (dB) Frequency Sweep over Temperature

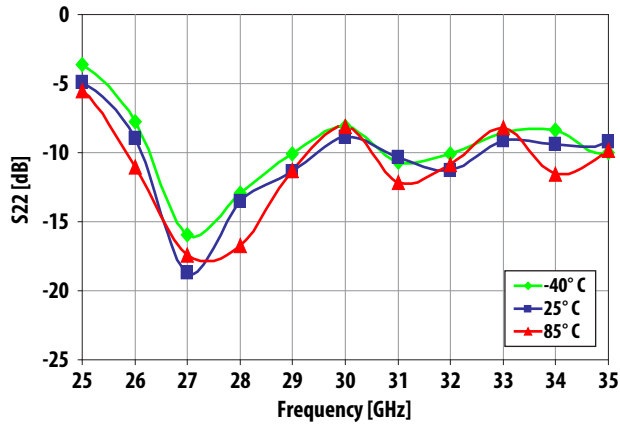

Figure 9. S_{22} (dB) Frequency Sweep over Temperature

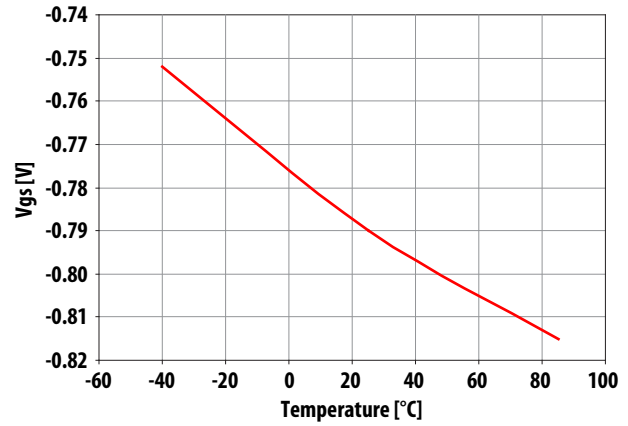

Figure 10. Typical V_{gs} for $I_{dq} = 1.4\text{ A}$ over Temperature

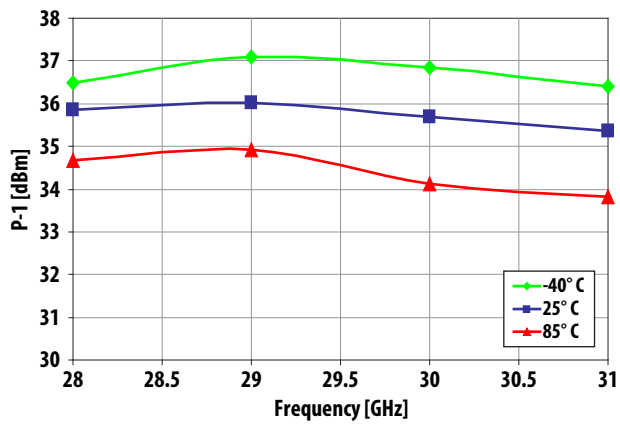

Figure 11. P_{-1} (dBm) Frequency Sweep over Temperature

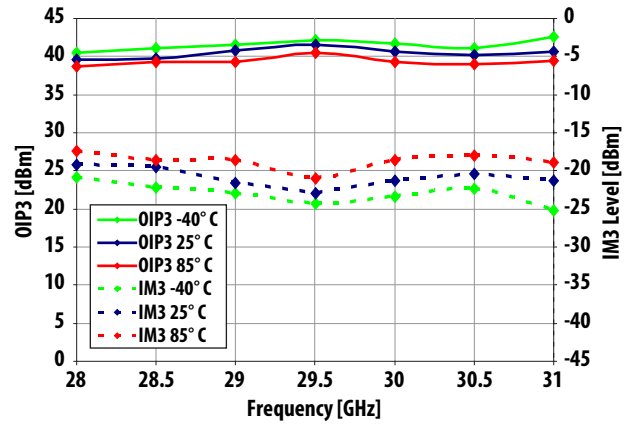

Figure 12. OIP3 (dBm) and IM3 level (dBm) Frequency Sweep over Temperature @ $P_o = 20\text{ dBm/tone}$

Selected Performance Plots Over Operating Supply Voltage Range

All data measured on a 2.4 mm connector based evaluation board at $T_A = 25^\circ\text{C}$, and $50\ \Omega$ at all ports.

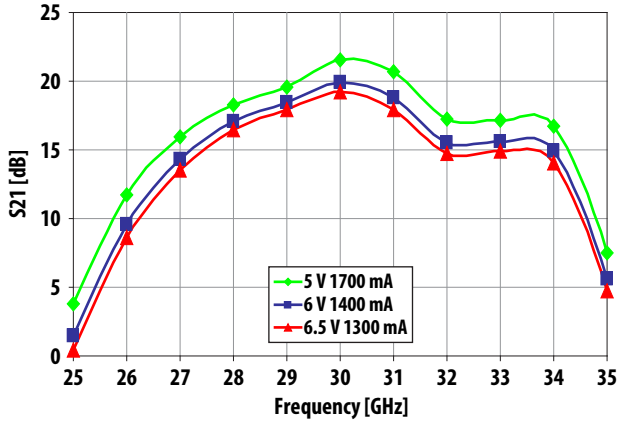

Figure 13. S_{21} (dB) Frequency Sweep

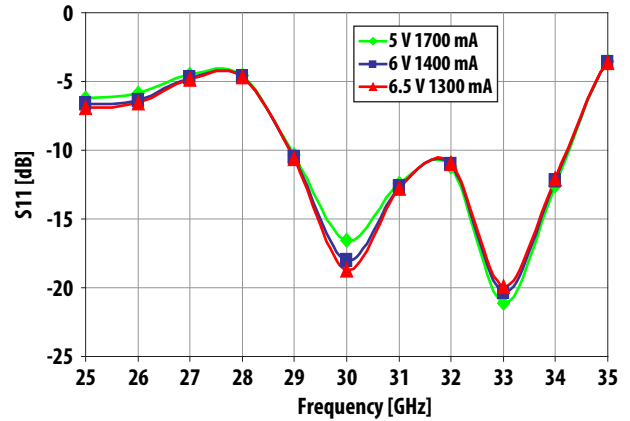

Figure 14. S_{11} (dB) Frequency Sweep

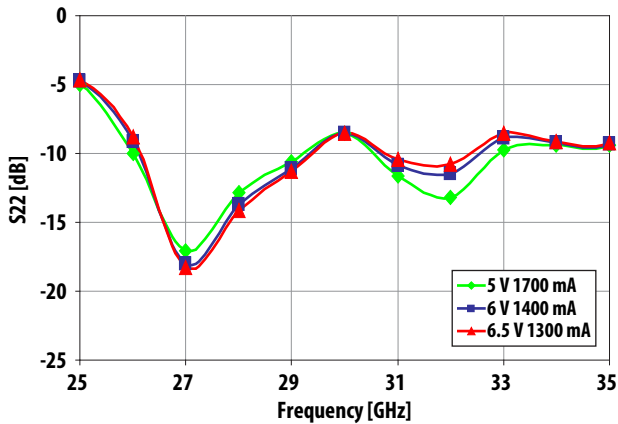

Figure 15. S_{22} (dB) Frequency Sweep

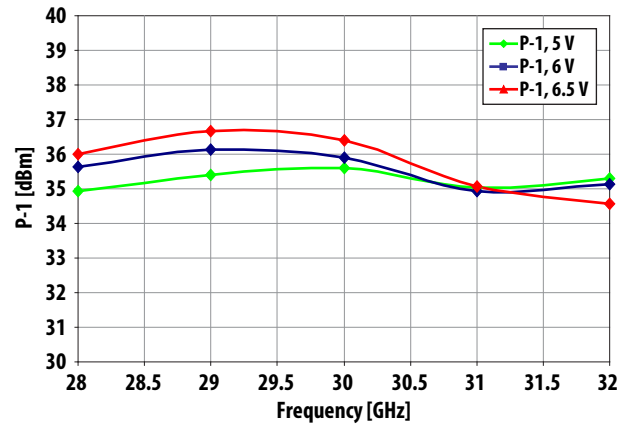

Figure 16. P_{1dB} (dBm) Frequency Sweep

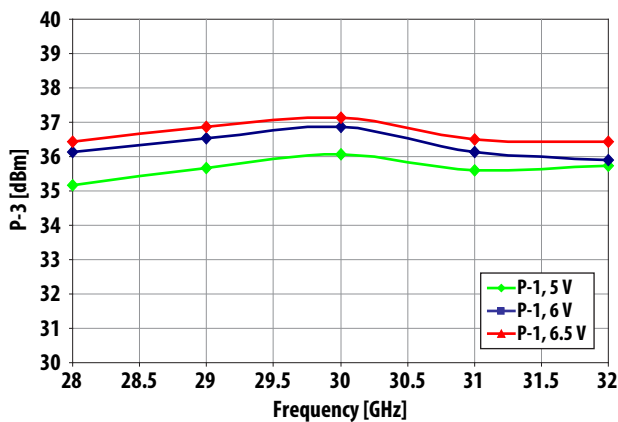

Figure 17. P_{3dB} (dBm) Frequency Sweep

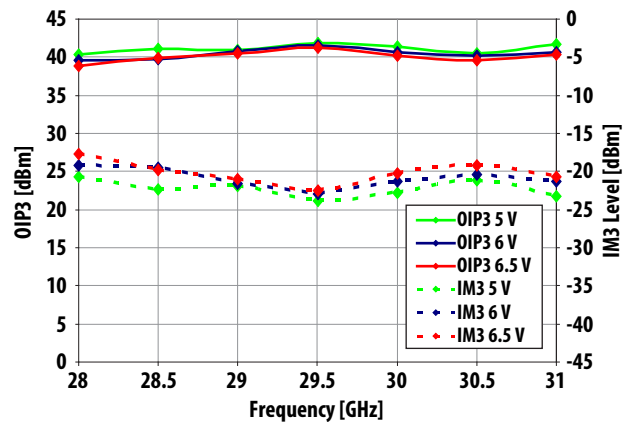

Figure 18. OIP3 and IM3 level vs. Frequency Sweep @ $P_o = 20\ \text{dBm/tone}$

Application Circuit

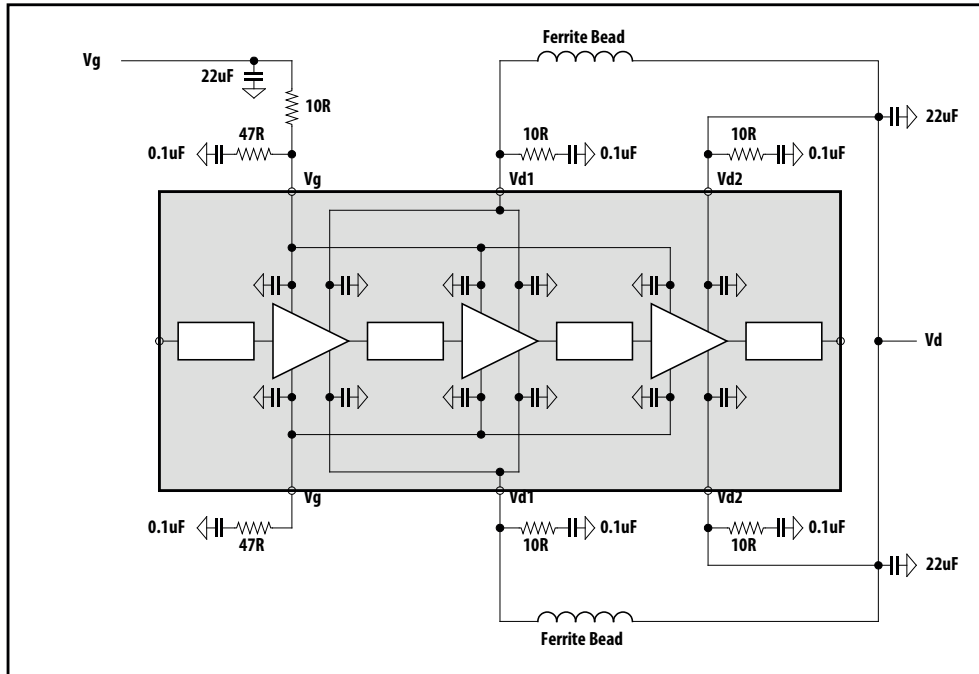

Figure 19. Application Circuit

Table 3. Typical Test Conditions:

PIN		
Vd1, 2	6V	Drain Supply Voltage
$I_{dsq} = I_{d1} + I_{d2}$	1400mA	Quiescent Drain Current
Vg	-0.79	Gate Supply Voltage

Table 4. Pin Description

Pin No.	Function
1	Vg
2	Vd1
3	Vd2
4	RF_OUT
5	Vd2
6	Vd1
7	Vg
8	RF_IN

Demo-board

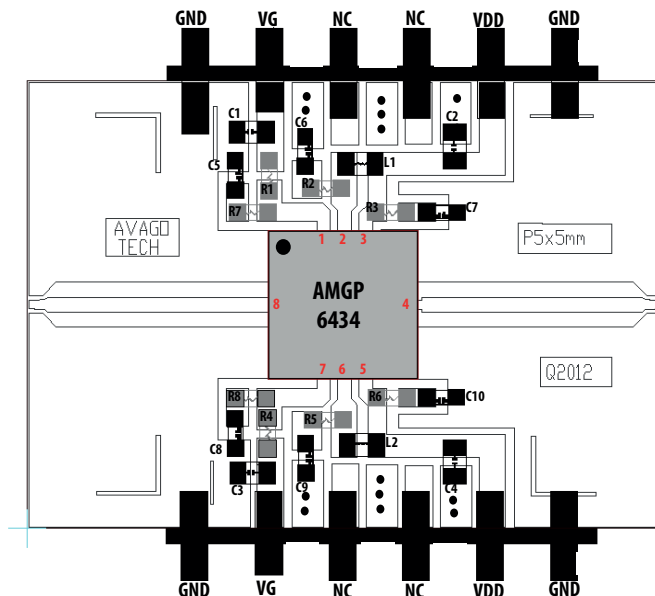

Figure 20. Demo-board

Table 5. Recommended Passive Components

Ref Designator	Value	Part Number
C1-C4	22 μ F	TDK C1608X5R0J226M DigiKey 445-8028-1-ND
C5-C10	0.1 μ F	0402 ANY
L1, L2	Ferrite Bead	Murata BLM18HG471SN1
R1-R6	10 Ω	0402 ANY
R7, R8	47	0402 ANY

Bias Sequence:

- Apply Vg = -1.5V
- Apply Vdd = 0V
- Increase Vdd to 6V
- Increase Vg to obtain $I_{dsq} = 1.4A$
- Apply RF
- Turn off in reverse order

Reliability Data

Please contact Avago Technical and/or Customer supports for more detail www.avagotech.com

Package Dimension, PCB Layout and Tape and Reel information

Please refer to Avago Technologies Application Note 5521, AMxP-xxxx production Assembly Process (Land Pattern B).

Part Number Ordering Information

Part Number	Devices per Container	Container
AMGP-6434-BLKG	10	antistatic bag
AMGP-6434-TR1G	100	7" Reel
AMGP-6434-TR2G	500	7" Reel

For product information and a complete list of distributors, please go to our web site: www.avagotech.com

Avago, Avago Technologies, and the A logo are trademarks of Avago Technologies in the United States and other countries.
Data subject to change. Copyright © 2005-2013 Avago Technologies. All rights reserved.
AV02-3204EN - September 24, 2013

