

MORNSUN®

URA_LD-20WR2 & URB_LD-20WR2 Series 20W, ULTRA-WIDE INPUT, ISOLATED & REGULATED SINGLE/DUAL OUTPUT DC-DC CONVERTER



Patent Protected RoHS c us

PART NUMBER SYSTEM

URB2405LD-20WR2

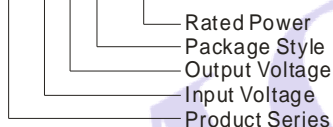

FEATURES

- Efficiency up to 90%
- 4:1 wide input voltage range
- Output over current, over voltage and input under voltage protection, Short circuit protection
- 1.5KVDC isolation
- Operating temperature range: -40°C ~ +85°C
- Six-sided metal shield
- Industry standard pinout
- Meet CISPR22/EN55022 CLASS A
- Meet UL60950 and EN60950
- A2S(chassis mounting)and A4S(DIN-Rail mounting) have the function of input reverse connection preventing

Application

URA_LD-20WR2 & URB_LD-20WR2 series are applied to wide voltage range input situation such as data transmission device, battery power supply device, tele-communication device, distributed power supply system, remote control system, industrial robot system etc.

SELECTION GUIDE

Approval	Model ^①	Input Voltage (VDC)		Output Voltage (VDC)	Output Current (mA)		Input Current (mA)(Typ.)		Reflection Ripple Current (mA,Typ.)	Max. Capacitive Load ^③ (μF)	Efficiency ^④ (% , typ.) @Max. Load
		Nominal (Range)	Max. ^②		Max.	Min.	@ Max.Load	@ No Load			
CE	URA2405LD-20WR2	24 (9-36)	40	±5	±2000	±100	969	20	30	4800	86
	URA2412LD-20WR2			±12	±834	±42	948	15		800	88
	URA2415LD-20WR2			±15	±667	±33	947	15		625	88
	URB2403LD-20WR2			3.3	5000	250	800	40		18700	86
	URB2405LD-20WR2			5	4000	200	916	60		9600	90
	URB2409LD-20WR2			9	2222	111	947	18		4700	88
	URB2412LD-20WR2			12	1667	84	937	15		1600	89
	URB2415LD-20WR2			15	1333	67	926	15		1000	90
	URB2424LD-20WR2			24	834	42	927	20		500	90
	UL/CE			URA4805LD-20WR2	48 (18-75)	80	±5	±2000		±100	485
URA4812LD-20WR2		±12	±834	±42			474	15	800	88	
URA4815LD-20WR2		±15	±667	±33			468	15	625	89	
URB4803LD-20WR2		3.3	5000	250			400	35	18700	86	
URB4805LD-20WR2		5	4000	200			463	35	9600	90	
URB4812LD-20WR2		12	1667	84			468	10	1600	89	
URB4815LD-20WR2		15	1333	67			463	10	1000	90	
URB4824LD-20WR2		24	834	42			463	10	500	90	

Note: ①Series with suffix "H" are heat sink mounting; series with suffix "A2S" are chassis mounting, with suffix "A4S" are DIN-Rail mounting, for example URB2405LD-20WHR2A2S is chassis mounting of with heat sink,URB2405LD-20WR2A4S is DIN-Rail mounting of without heat sink;If the application has a higher requirement for heat dissipation, you can choose modules with heat sink;
 ②Absolute maximum rating without damage on the converter;
 ③For dual-output-converters the given value is for one output (for both outputs the same value);
 ④The efficiency of "A2S" and "A4S" is approx. 2% lower for the protection of inverse polarity.

INPUT SPECIFICATIONS

Item	Test conditions	Min.	Typ.	Max.	Unit
Input Surge Voltage (1sec. max.)	24VDC Input	-0.7	--	50	VDC
	48VDC Input	-0.7	--	100	
Start-up Voltage	24VDC Input	--	--	9	
	48VDC Input	--	--	17.8	
Under Voltage Shutdown	24VDC Input	7.5	--	--	
	48VDC Input	16	--	--	
Start-up time	Nominal input & constant resistance load	--	10	--	ms
Ctrl*	Models ON	Ctrl open or connect TTL high level (2.5-12VDC)			
	Models OFF	Ctrl connect GND or low level (0-1.2VDC)			
	Input current (Models OFF)	--	1	--	mA
Input filter		Pi Filter			

Note:*The Ctrl control pin voltage is refer to GND.

OUTPUT SPECIFICATIONS

Item	Test Conditions	Min.	Typ.	Max.	Unit
Positive Output Voltage Accuracy		--	±1	±3	%
Negative Output Voltage Accuracy					
Output Voltage Balance	Dual output, Balance load	--	±0.5	±1	
Line Regulation	Full load, Input voltage from low to high	--	±0.2	±0.5	
Load Regulation	10% to 100% load	--	±0.5	±1	
Cross Regulation	Dual output,main output 50% load, Supplement output from 10% to 100% load	--	--	±5	
Transient Recovery Time	25% load step change	--	300	500	µs
Transient Response Deviation		--	±3	±5	%
Temperature Drift	100% load	--	±0.02	--	%/°C
Ripple & Noise *	20MHz Bandwidth	--	70	100	mVp-p
Output voltage Trim		--	±10%	--	VDC
Output Over Voltage Protection	3.3V output	--	3.9	--	
	5V output	--	6.2	--	
	9V output	--	10.8	--	
	12V output	--	15	--	
	15V output	--	18	--	
24V output	--	30	--		
Over Current Protection	Input voltage range	--	160	--	%
Output Short Circuit Protection		Hiccup, Continuous, automatic recovery			

Note:* Ripple and noise tested with "parallel cable" method. See detailed operation instructions at *DC-DC application notes*.

COMMON SPECIFICATIONS

Item	Test Conditions	Min.	Typ.	Max.	Unit	
Isolation Voltage	Input-Output, Tested for 1 minute ,leakage current less than 1 mA	1500	--	--	VDC	
Isolation Resistance	Input-Output, Test at 500VDC	1000	--	--	MΩ	
Isolation Capacitance	24V output	--	2000	--	pF	
	Others	--	1000	--		
Switching Frequency	URB2424LD-20WR2	PWM mode	315	--	345	KHz
	Others	PWM mode	--	300	--	
MTBF	MIL-HDBK-217F@25°C	1000	--	--	K hours	
Safety approvals	URB48XXLD-20WR2	UL60950, EN60950				
	Others	EN60950				

Case Material		Aluminum Alloy			
Size	PCB mounting (Without heat sink)	50.80×25.40×11.80			mm
	PCB mounting (With heat sink)	50.80×25.40×16.30			
	A2S Chassis mounting (Without heat sink)	76.00×31.50×21.20			
	A2S Chassis mounting (With heat sink)	76.00×31.50×25.10			
	A4S DIN-Rail mounting (Without heat sink)	76.00×31.50×25.80			
	A4S DIN-Rail mounting (With heat sink)	76.00×31.50×29.70			
Weight	PCB mounting (Without heat sink)	--	28	--	g
	PCB mounting (With heat sink)	--	36	--	
	A2S Chassis mounting (Without heat sink)	--	50	--	
	A2S Chassis mounting (With heat sink)	--	58	--	
	A4S DIN-Rail mounting (Without heat sink)	--	70	--	
	A4S DIN-Rail mounting (With heat sink)	--	78	--	

ENVIRONMENTAL SPECIFICATIONS

Item	Test Conditions	Min.	Typ.	Max.	Unit
Storage Humidity	Non condensing	5	--	95	%
Operating Temperature	See Temperature Derating Curve (Figure 3)	-40	--	85	°C
Storage Temperature		-55	--	125	
The Max. Case Temperature	Operating Temperature curve range	--	--	105	
Lead Temperature	1.5mm from case for 10 seconds	--	--	300	
Cooling		Free air convection			
Shake		10-55Hz, 10G, 30 Min. along X, Y and Z			

EMC SPECIFICATIONS

EMI	CE	CISPR22/EN55022 CLASS A (Without External Circuit) / CLASS B (External Circuit Refer to Figure1-②)			
	RE	CISPR22/EN55022 CLASS A (Without External Circuit) / CLASS B (External Circuit Refer to Figure1-②)			
EMS	ESD	IEC/EN61000-4-2	Contact ±4KV	perf. Criteria B	
	RS	IEC/EN61000-4-3	10V/m	perf. Criteria A	
	EFT	IEC/EN61000-4-4	±2KV (External Circuit Refer to Figure1-①)	perf. Criteria B	
	Surge	IEC/EN61000-4-5	±2KV (External Circuit Refer to Figure1-①)	perf. Criteria B	
	CS	IEC/EN61000-4-6	3 Vr.m.s	perf. Criteria A	
	Voltage dips, short and interruptions immunity	IEC/EN61000-4-29	0%-70%	perf. Criteria B	

EMC RECOMMENDED CIRCUIT

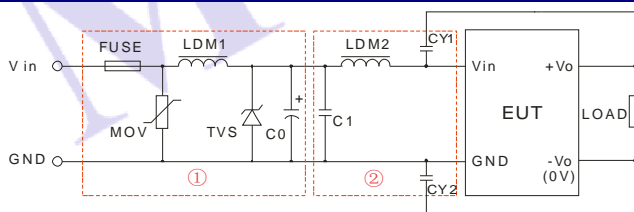

(Figure1)

Note:1.In Figure 1,part①is EMS recommended external circuit, part ②is EMI recommended external circuit(CLASS B). Choose according to requirements.

Recommended external circuit parameters:

Model	URA/B24_LD-20WR2	URA/B48_LD-20WR2
FUSE	Choose according to practical input current	
MOV	S14K35	S14K60
LDM1	56μH	
TVS	SMCJ48A	SMCJ90A
C0	330μF/50V	330μF/100V
C1	1μF /50V	1μF /100V
LDM2	4.7μH	
CY1、CY2	1nF/2KV	

EMC RECOMMENDED CIRCUIT PCB LAYOUT

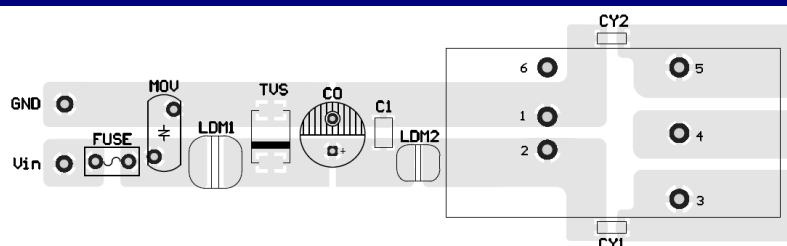

(Figure 2)

Note: The pad space between input and output (CY1/CY2) must ≥2mm.

EMC TEST WAVEFORM(CLASS B TEST CIRCUIT)

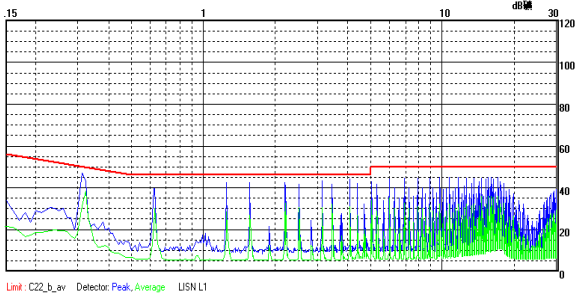

URB2405LD-20WR2 CE (Positive line)

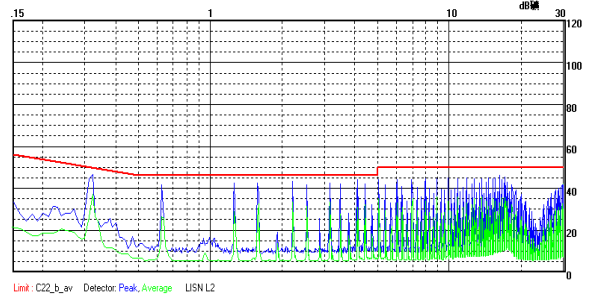

URB2405LD-20WR2 CE (Negative line)

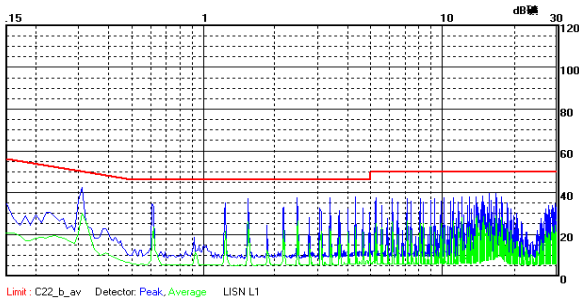

URB4815LD-20WR2 CE (Positive line)

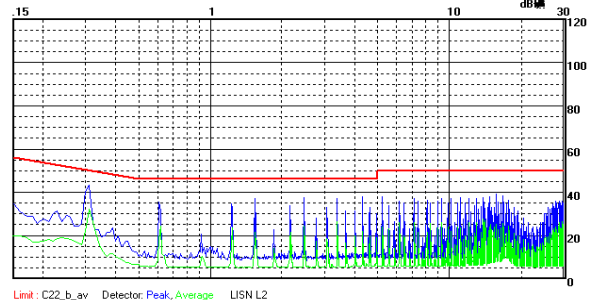

URB4815LD-20WR2 CE (Negative line)

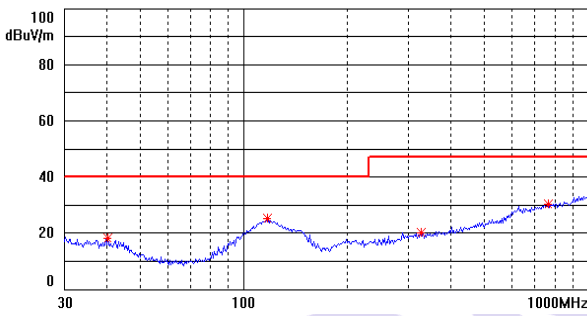

URB2405LD-20WR2 RE(Horizontal)

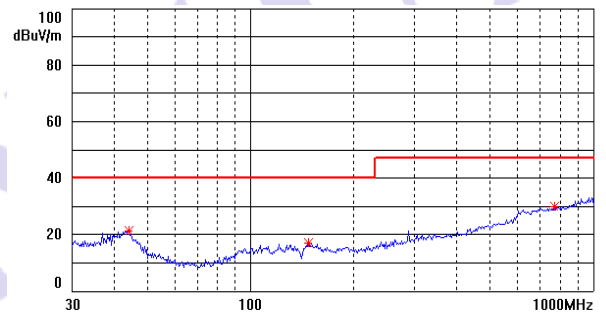

URB2405LD-20WR2 RE(Vertical)

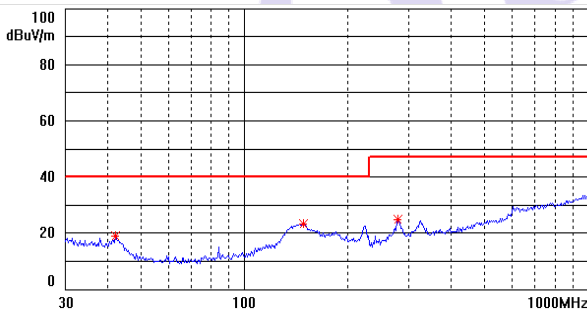

URB4815LD-20WR2 RE(Horizontal)

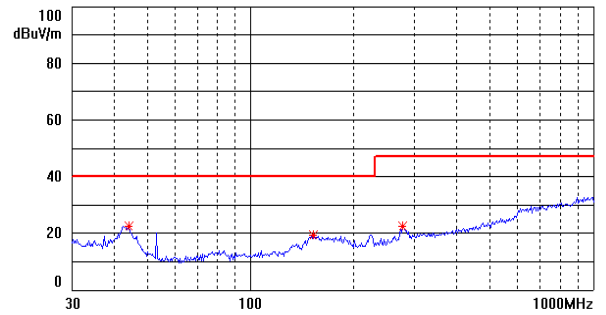

URB4815LD-20WR2 RE(Vertical)

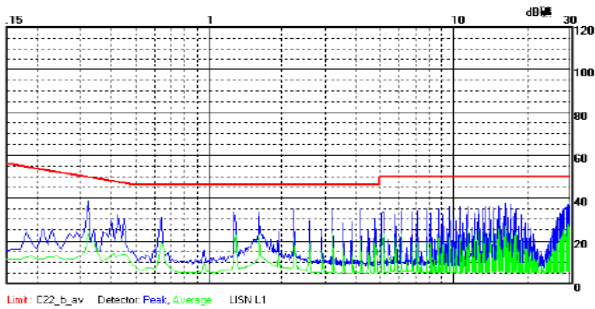

URA2405LD-20WR2 CE (Positive line)

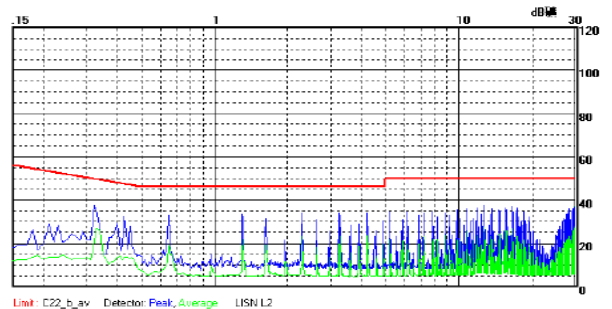

URA2405LD-20WR2 CE (Negative line)

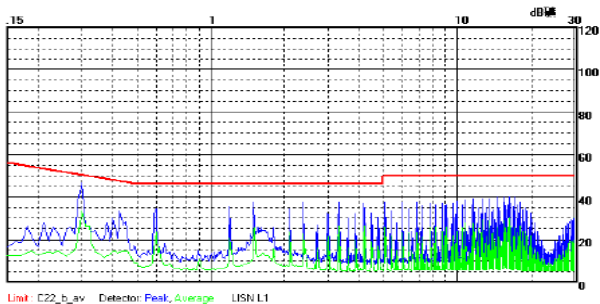

URA4815LD-20WR2 CE (Positive line)

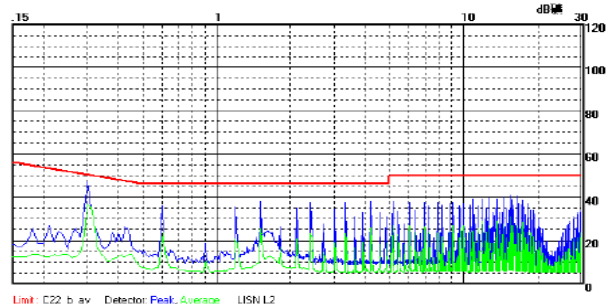

URA4815LD-20WR2 CE (Negative line)

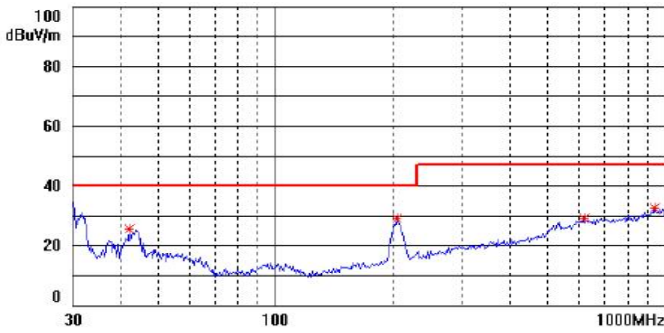

URA2405LD-20WR2 RE(Horizontal)

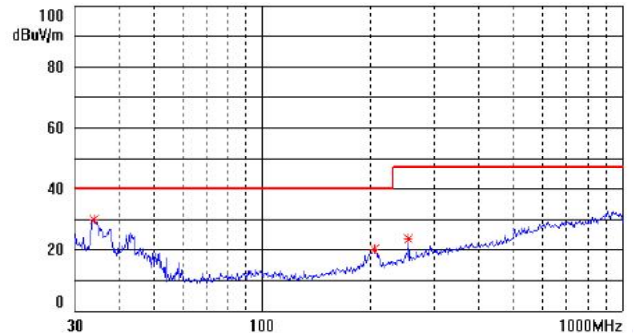

URA2405LD-20WR2 RE(Horizontal)

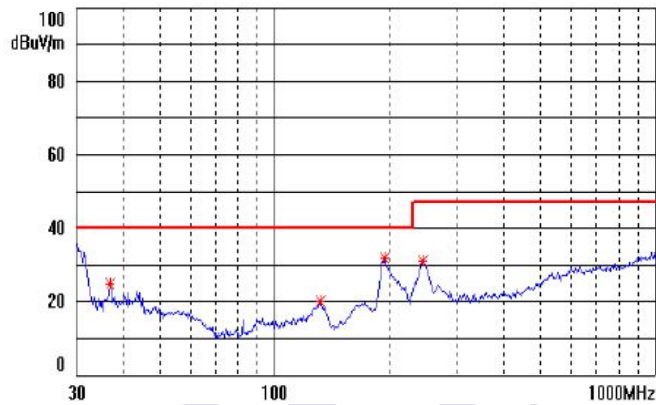

URA4815LD-20WR2 RE(Horizontal)

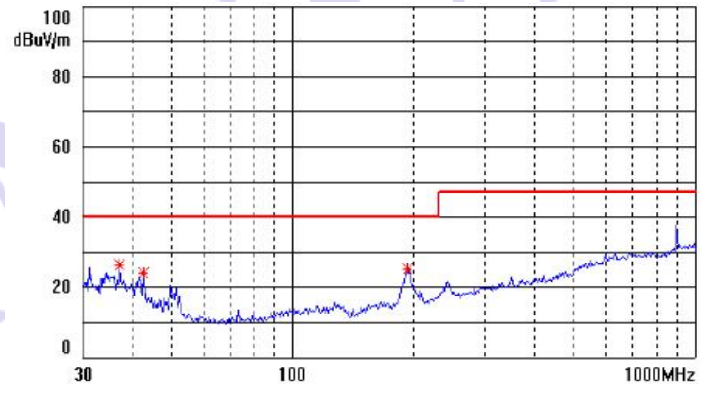

URA4815LD-20WR2 RE(Horizontal)

PRODUCT TYPICAL CURVE

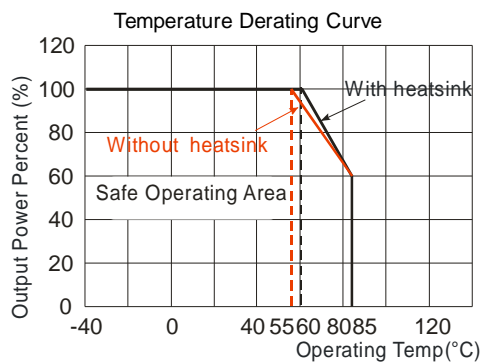

(Figure 3)

**Efficiency VS Input Voltage curve
(Full Load)**

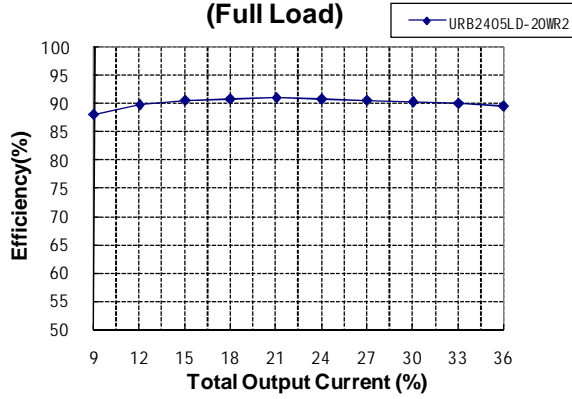

**Efficiency VS Output Load curve
(Vin=Vin-nominal)**

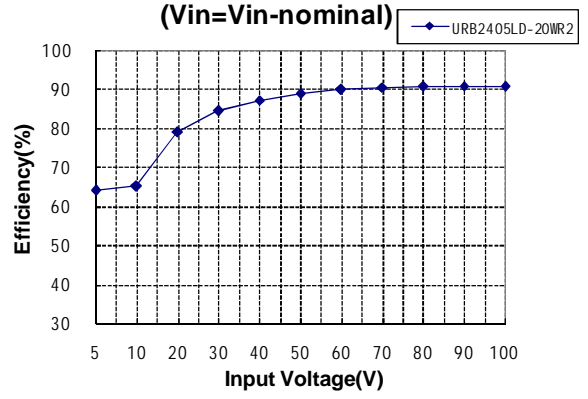

**Efficiency VS Input Voltage curve
(Full Load)**

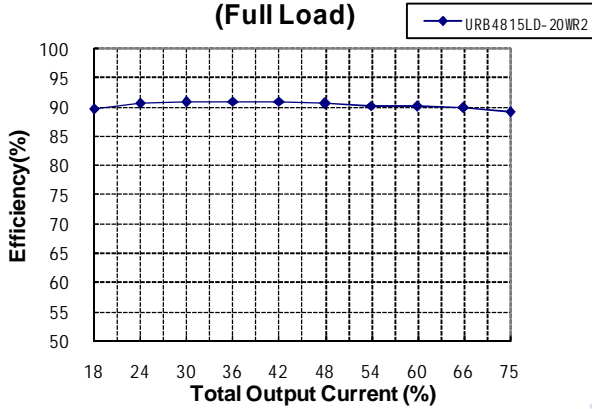

**Efficiency VS Output Load curve
(Vin=Vin-nominal)**

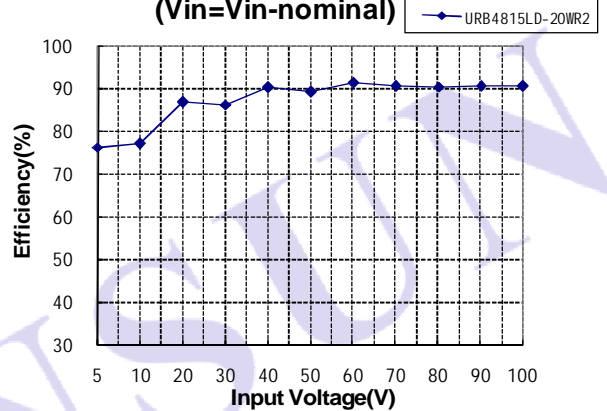

**Efficiency VS Input Voltage curve
(Full Load)**

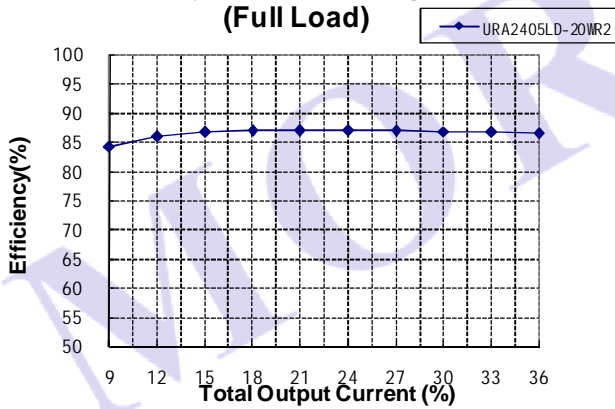

**Efficiency VS Output Load curve
(Vin=Vin-nominal)**

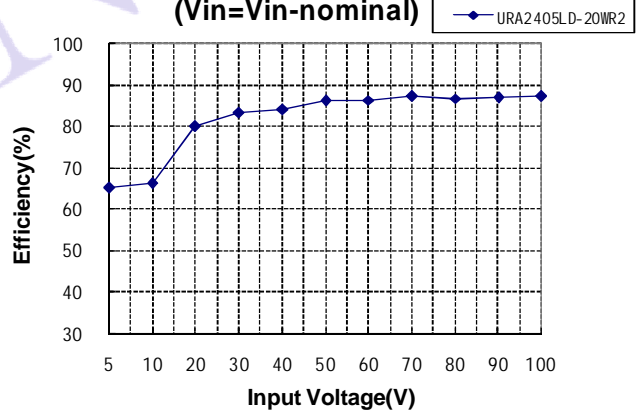

**Efficiency VS Input Voltage curve
(Full Load)**

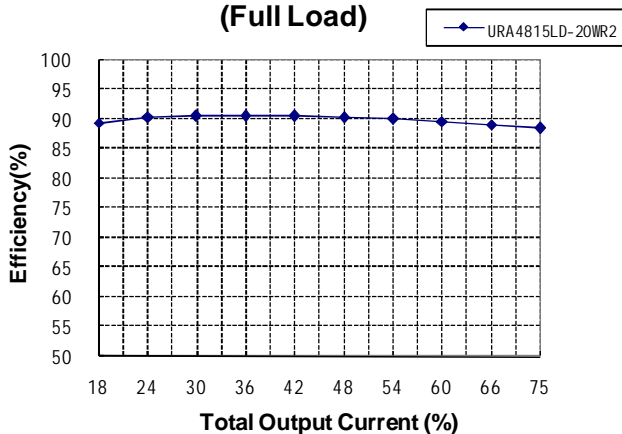

**Efficiency VS Output Load curve
(Vin=Vin-nominal)**

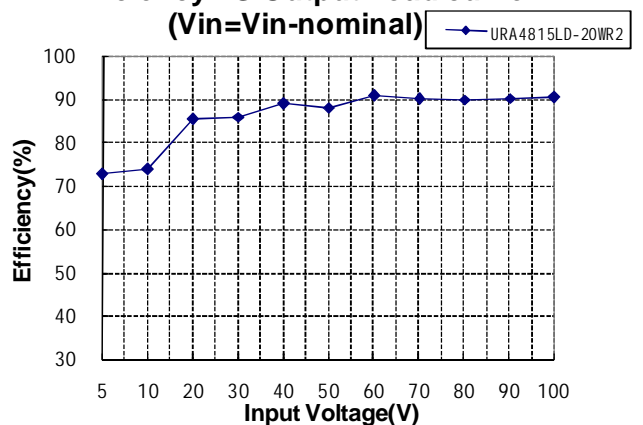

PCB MOUNTING OUTLINE DIMENSIONS, RECOMMENDED FOOTPRINT (WITHOUT HEATSINK)

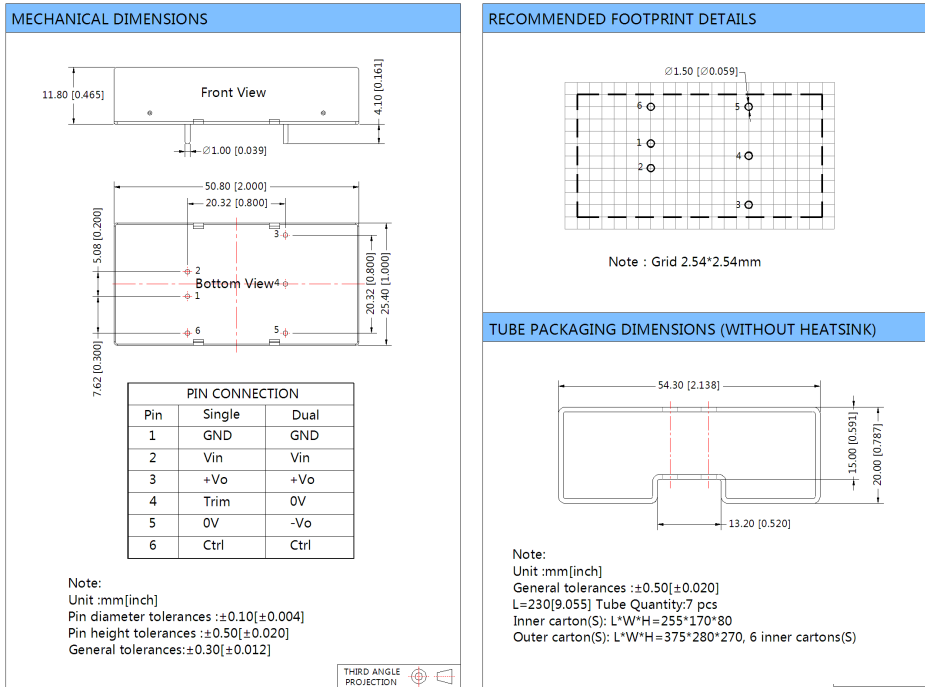

PCB MOUNTING OUTLINE DIMENSIONS (WITH HEATSINK)

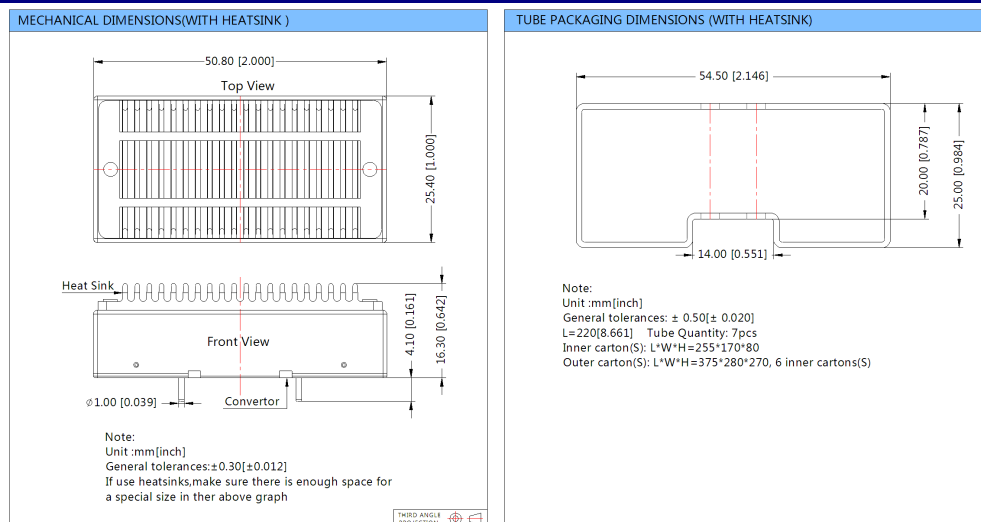

URA-LD-20WR2A2S&URB-LD-20WR2A2S CHASSIS MOUNTING OUTLINE DIMENSIONS



Footprint Details						
Pin	1	2	3	4	5	6
Dual	Ctrl	GND	Vin	-Vo	0V	+Vo
Single	Ctrl	GND	Vin	0V	Trim	+Vo

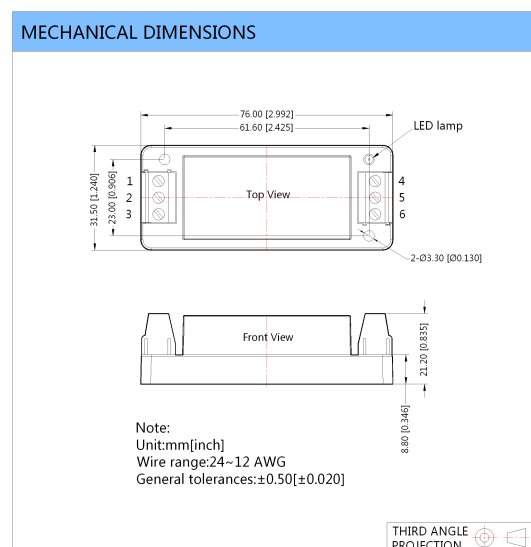

URA_LD-20WHR2A2S&URB_LD-20WHR2A2S CHASSIS MOUNTING OUTLINE DIMENSIONS



Footprint Details						
Pin	1	2	3	4	5	6
Dual	Ctrl	GND	Vin	-Vo	0V	+Vo
Single	Ctrl	GND	in	0V	Trim	+Vo

MECHANICAL DIMENSIONS(WITH HEATSINK)

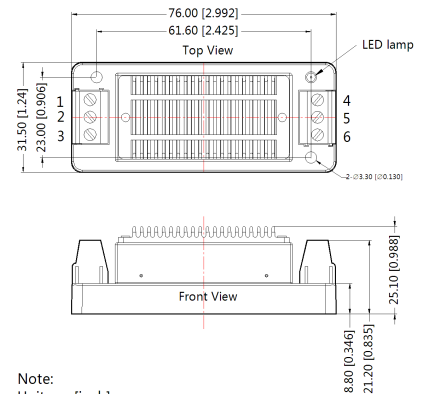

THIRD ANGLE PROJECTION

URA-LD-20WR2A4S&URB-LD-20WR2A4S DIN-RAIL MOUNTING OUTLINE DIMENSIONS



It is hanged on the TS35 rail

Footprint Details						
Pin	1	2	3	4	5	6
Dual	Ctrl	GND	Vin	-Vo	0V	+Vo
Single	Ctrl	GND	Vin	0V	Trim	+Vo

MECHANICAL DIMENSIONS

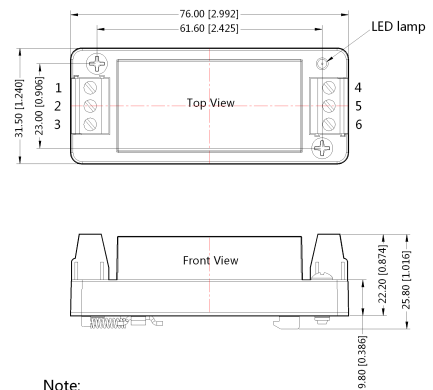

THIRD ANGLE PROJECTION

URA_LD-20WHR2A4S&URB_LD-20WHR2A4S DIN-RAIL MOUNTING OUTLINE DIMENSIONS



DIN-rail modules are fitting to TS35 rails

Footprint Details						
Pin	1	2	3	4	5	6
Dual	Ctrl	GND	Vin	-Vo	0V	+Vo
Single	Ctrl	GND	Vin	0V	Trim	+Vo

MECHANICAL DIMENSIONS

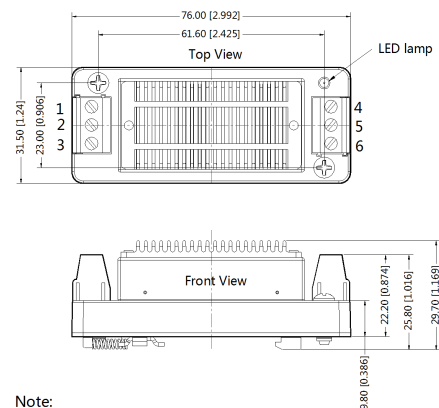

THIRD ANGLE PROJECTION

PACKAGE DIAGRAM

Special Package Series (A2S/A4S)



TEST CONFIGURATIONS

Input Reflected-Ripple Current Test Setup

Input reflected-ripple current is measured with an inductor L_{in} and Capacitor C_{in} to simulate source impedance.

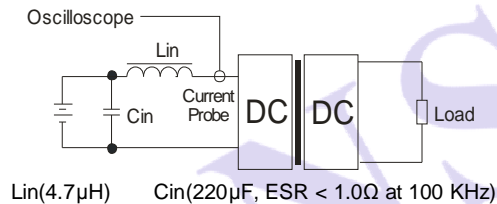

TRIM APPLICATION & TRIM RESISTANCE

Application circuit for TRIM (Part in broken line is the interior of models)

Formula for resistance of Trim

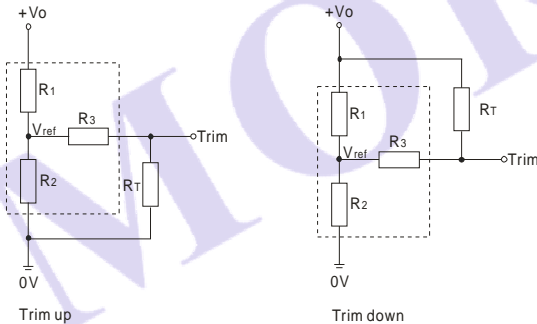

$$\text{up: } R_T = \frac{aR_2}{R_2 - a} - R_3$$

$$a = \frac{V_{ref}}{V_o' - V_{ref}} \cdot R_1$$

$$\text{down: } R_T = \frac{aR_1}{R_1 - a} - R_3$$

$$a = \frac{V_o' - V_{ref}}{V_{ref}} \cdot R_2$$

Note: Leave open if not used; Value for R_1 , R_2 , R_3 , and V_{ref} refer to the above table 1; R_T : Resistance of Trim; a : User-defined parameter, no actual meanings.; V_o' : The trim up/down voltage.

(Table 1)

Parameter \ V_o	3.3(VDC)	5(VDC)	9(VDC)	12(VDC)	15(VDC)	24(VDC)
$R_1(K\Omega)$	4.801	2.883	7.5	10.971	14.497	24.872
$R_2(K\Omega)$	2.863	2.864	2.864	2.864	2.864	2.863
$R_3(K\Omega)$	15	10	15	17.8	17.8	20
$V_{ref}(V)$	1.24	2.5	2.5	2.5	2.5	2.5

DESIGN CONSIDERATIONS

① Recommended circuit

All the URA_LD-20WR2 & URB_LD-20WR2 Series have been tested according to the following recommended testing circuit before leaving factory (see Figure 4).

If you want to further decrease the input/output ripple, you can increase a capacitance properly or choose capacitors with low ESR, but the greatest capacitance of its filter capacitor must less than the Max. Capacitive Load. The recommended capacitance of its filter capacitor sees (Table 2).

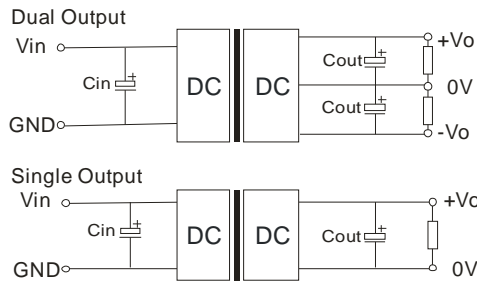

(Figure 4)

EXTERNAL CAPACITOR TABLE (Table 2)

Single Vout (VDC)	Cout (μF)	Cin (μF)	Dual Vout (VDC)	Cout (μF)	Cin (μF)
3.3V/5	470	100	±5	220	100
9/12/15	220		±12/±15	100	
24	100		--	--	

②It is not recommended to increase the output power capability by connecting two or more converters in parallel. The product is not hot-swappable

Note:

- 1.Min. load shouldn't be less than 5%, otherwise ripple maybe increased dramatically, If the product operates under min. load, it may not be guaranteed to meet all specification listed. Operation under minimum load will not damage the converter.
- 2.Recommended Dual output models unbalanced load: $\leq \pm 5\%$, If the product operates $> \pm 5\%$, it may not be guaranteed to meet all specification Listed, please contact our technical person for more detail.
- 3.Max. Capacitive Load is tested at nominal input voltage and full load.
- 4.All specifications measured at $T_a=25^\circ\text{C}$, humidity $<75\%$, nominal input voltage and rated output load unless otherwise specified.
- 5.In this datasheet, all the test methods of indications are based on our corporate standards.
- 6.All characteristics are for listed model, non-standard models may perform differently, please contact our technical person for more detail.
- 7.Contact us for your specific requirement.
- 8.Specifications of this product are subject to changes without prior notice.

MORNSUN Science & Technology Co.,Ltd.

Address: No. 5, Kehui St. 1, Kehui development center, Science Ave., Guangzhou Science City, Luogang district, Guangzhou,P.R.China.

Tel: 86-20-38601850

Fax:86-20-38601272

E-mail: info@mornsun.cn

[Http://www.mornsun-power.com](http://www.mornsun-power.com)