

SA5511 / SA5511(B)**1. Features**

- ◆ Red Colored transparency lens type
- ◆ $\phi 5\text{mm}$ (T-13/4) all plastic mold type
- ◆ High reliability and low power consumption

2. Outline Dimensions

unit : mm

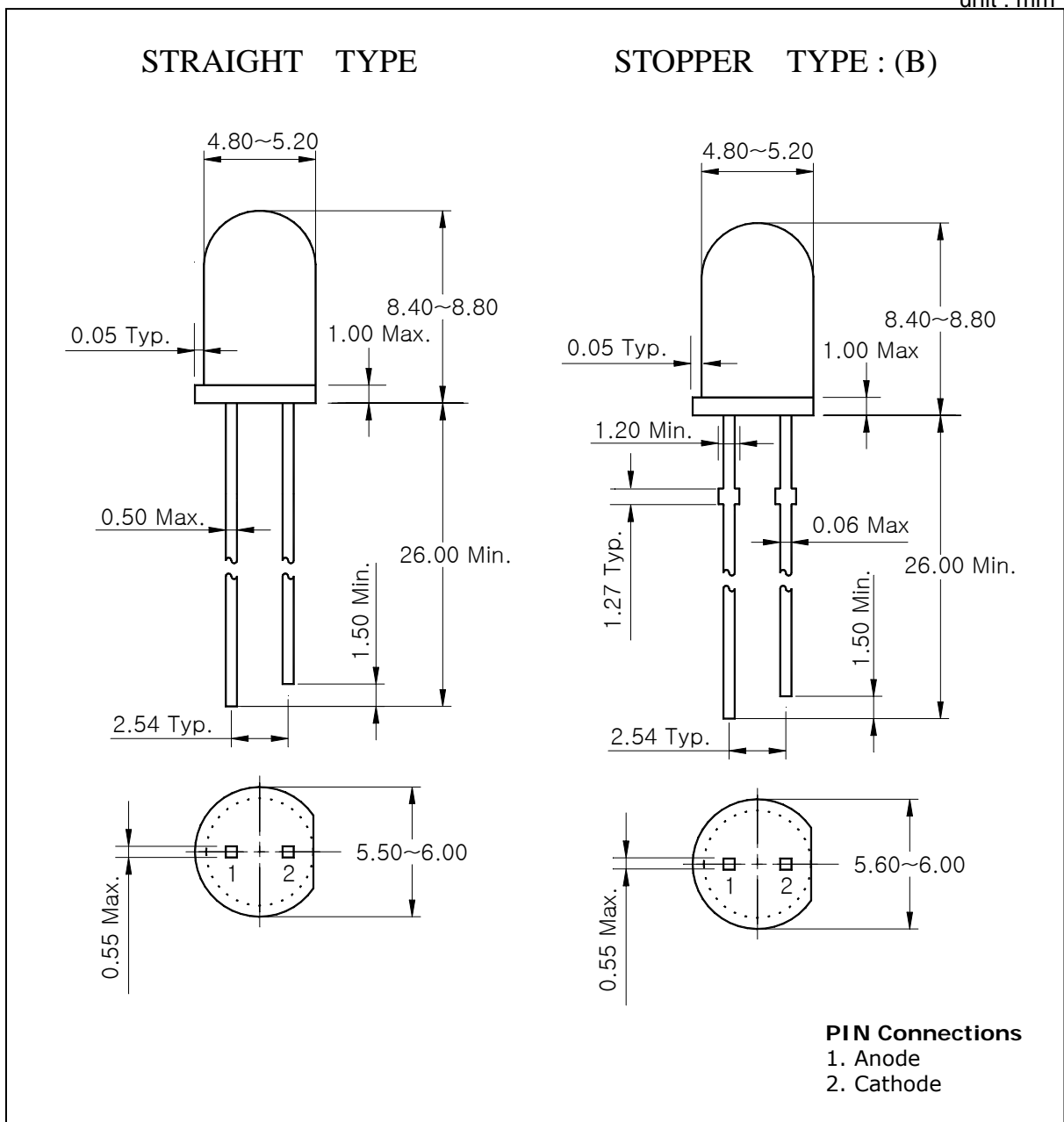

The contents of this data sheet are subject to change without advance notice for the purpose of improvement.
When using this product, would you please refer to the latest specifications.

SA5511 / SA5511(B)**3. Absolute Maximum Ratings**

(Ta=25°C)

Characteristic	Symbol	Rating	Unit
Power dissipation	P_D	75	mW
Forward current	I_F	30	mA
*1Peak forward current	I_{FP}	50	mA
Reverse voltage	V_R	4	V
Operating temperature range	T_{opr}	-25~85	°C
Storage temperature range	T_{stg}	-30~100	°C
*2Soldering temperature	T_{sol}	260°C for 10 seconds	

*1.Duty ratio = 1/16, Pulse width = 0.1ms

*2.Keep the distance more than 2.0mm from PCB to the bottom of LED package

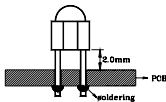
**4. Electrical / Optical Characteristics**

(Ta=25°C)

Characteristic	Symbol	Test Condition	Min	Typ	Max	Unit
Forward voltage	V_F	$I_F=20\text{mA}$	-	2.1	2.5	V
*4Luminous intensity	I_V	$I_F=20\text{mA}$	43	-	155	mcd
Peak wavelength	λ_P	$I_F=20\text{mA}$	-	630	-	nm
Spectrum bandwidth	$\Delta\lambda$	$I_F=20\text{mA}$	-	35	-	nm
Reverse current	I_R	$V_R=4\text{V}$	-	-	10	uA
*3Half angle	$\theta_{1/2}$	$I_F=20\text{mA}$	-	± 20	-	deg

*3. $\theta_{1/2}$ is the off-axis angle where the luminous intensity is 1/2 the peak intensity*4. Luminous intensity maximum tolerance for each grade classification limit is $\pm 18\%$

*4. Luminous Intensity Classification

J	K	L
43 ~ 68	68 ~ 100	100 ~ 155

The contents of this data sheet are subject to change without advance notice for the purpose of improvement.
When using this product, would you please refer to the latest specifications.

5. Characteristic Diagrams

Fig. 1 $I_F - V_F$

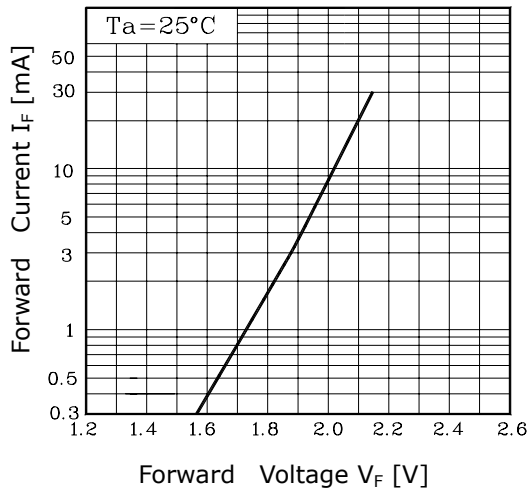

Fig. 2 $I_V - I_F$

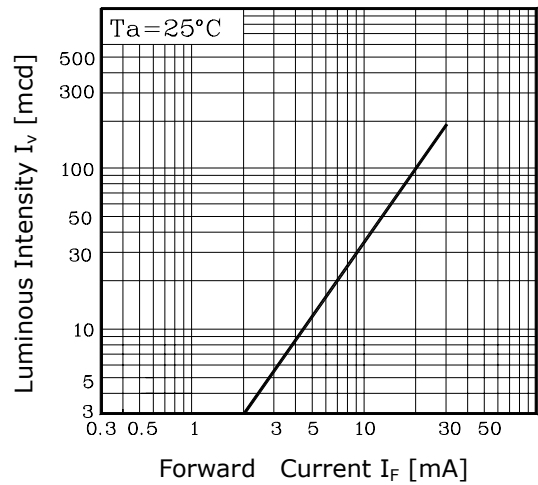

Fig. 3 $I_F - T_a$

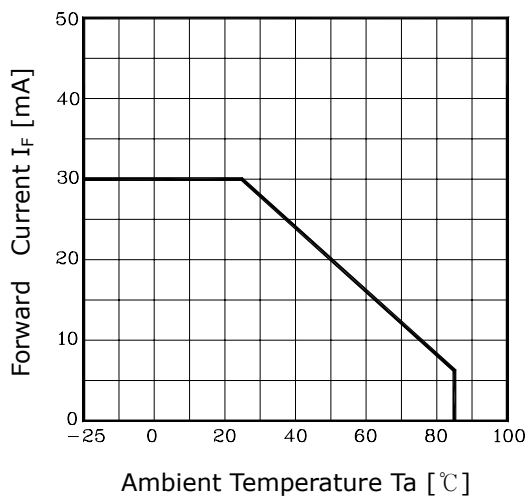

Fig. 4 Spectrum Distribution

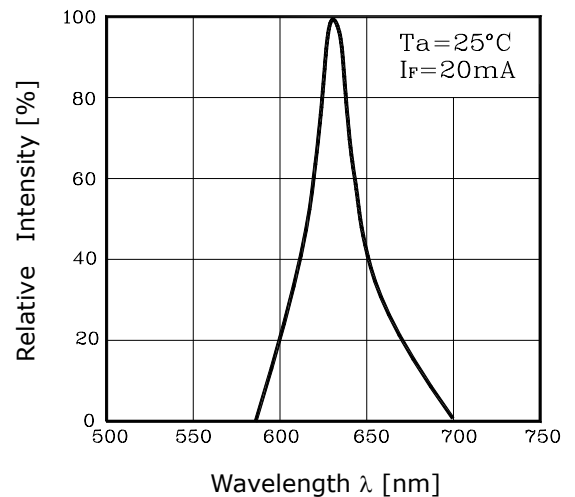
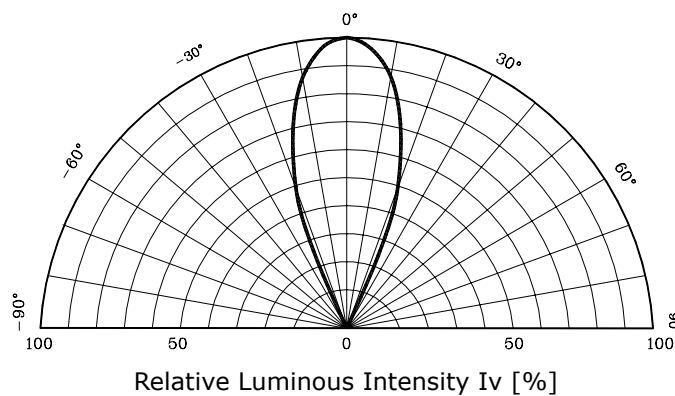

Fig. 5 Radiation Diagram



The contents of this data sheet are subject to change without advance notice for the purpose of improvement. When using this product, would you please refer to the latest specifications.