

Product Summary

$V_{(BR)DSS}$	$R_{DS(ON)}$	I_D $T_A = +25^\circ C$
-250V	14Ω @ $V_{GS} = 10V$	-265mA

Description

This new generation trench MOSFET features a unique structure combining the benefits of low on-resistance and fast switching, making it ideal for high efficiency power management applications.

Applications

- Earth Recall and Dialling Switches
- Electronic Hook Switches
- High Voltage Power MOSFET Drivers
- Telecom Call Routers
- Solid State Relays

Features and Benefits

- High Voltage
- Low On-resistance
- Fast Switching Speed
- Low Gate Drive
- Low Threshold
- **Lead-Free Finish; RoHS Compliant (Notes 1 & 2)**
- **Halogen and Antimony Free. "Green" Device (Note 3)**
- **Qualified to AEC-Q101 Standards for High Reliability**

Mechanical Data

- Case: SOT223
- Case Material: Molded Plastic, "Green" Molding Compound; UL Flammability Classification Rating 94V-0
- Moisture Sensitivity: Level 1 per J-STD-020
- Terminals: Matte Tin Finish
- Weight: 0.112 grams (Approximate)

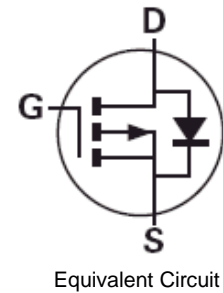
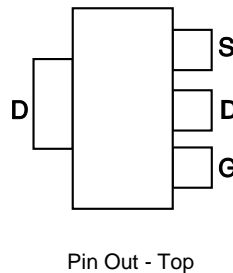
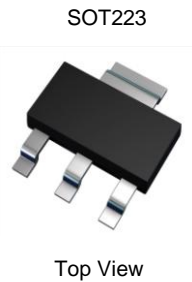

Ordering Information (Note 4)

Part Number	Marking	Reel size (inches)	Tape width (mm)	Quantity per reel
ZVP4525GTA	ZVP4525	7	12	1,000

- Notes:
1. EU Directive 2002/95/EC (RoHS) & 2011/65/EU (RoHS 2) compliant. All applicable RoHS exemptions applied.
 2. See http://www.diodes.com/quality/lead_free.html for more information about Diodes Incorporated's definitions of Halogen- and Antimony-free, "Green" and Lead-free.
 3. Halogen- and Antimony-free "Green" products are defined as those which contain <900ppm bromine, <900ppm chlorine (<1500ppm total Br + Cl) and <1000ppm antimony compounds.
 4. For packaging details, go to our website at <http://www.diodes.com/products/packages.html>.

Marking Information

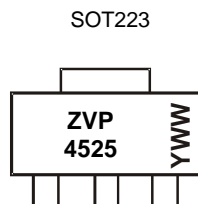

ZVP4525 = Product Type Marking Code
 YWW = Date Code Marking
 Y or \bar{Y} = Last Digit of Year (ex: 5 = 2015)
 WW or $\bar{W}W$ = Week Code (01~53)

Maximum Ratings (@T_A = +25°C, unless otherwise specified.)

Characteristic	Symbol	Value	Unit
Drain-Source Voltage	V _{DSS}	-250	V
Gate-Source Voltage	V _{GSS}	±40	V
Continuous Drain Current @V _{GS} = 10V; T _A = +25°C (Note 5)	I _D	-265	mA
@V _{GS} = 10V; T _A = +70°C (Note 5)		-212	
Pulsed Drain Current (Note 7)	I _{DM}	-1	A
Continuous Source Current (Body Diode)	I _S	-0.75	A
Pulsed Source Current (Body Diode)	I _{SM}	-1	A

Thermal Characteristics (@T_A = +25°C, unless otherwise specified.)

Characteristic	Symbol	Value	Unit
Power Dissipation at T _A = +25°C (Note 5)	P _D	2.0	W
Linear Derating Factor		16	mW/°C
Thermal Resistance, Junction to Ambient (Note 5)	R _{θJA}	63	°C/W
Thermal Resistance, Junction to Ambient (Note 6)	R _{θJA}	26	°C/W
Operating and Storage Temperature Range	T _J , T _{STG}	-55 to +150	°C

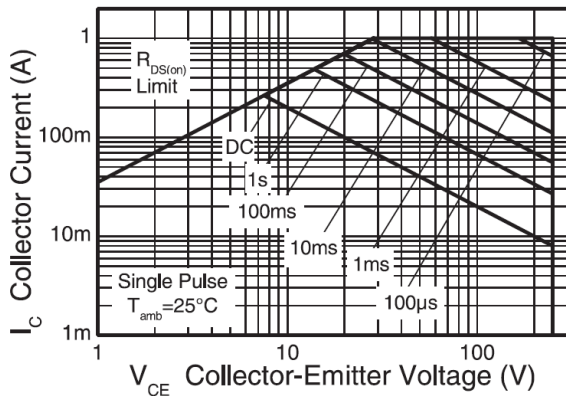

Safe Operating Area

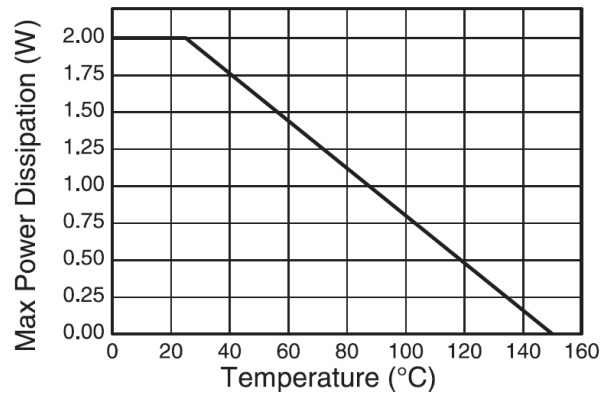

Derating Curve

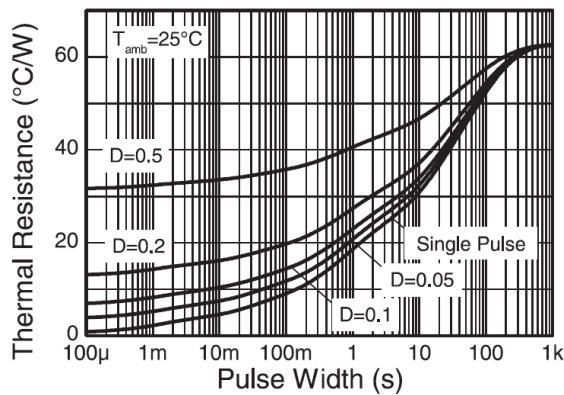

Transient Thermal Impedance

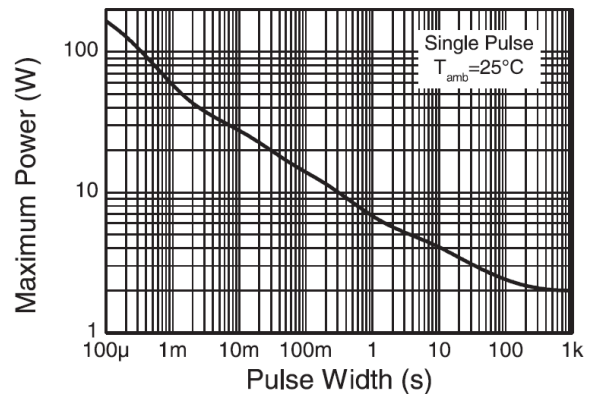

Pulse Power Dissipation

Electrical Characteristics (@T_A = +25°C, unless otherwise specified.)

Characteristic	Symbol	Min	Typ	Max	Unit	Test Condition
OFF CHARACTERISTICS						
Drain-Source Breakdown Voltage	BV _{DSS}	-250	-285	-	V	V _{GS} = 0V, I _D = -1mA
Zero Gate Voltage Drain Current	I _{DSS}	-	-30	-500	nA	V _{DS} = -250V, V _{GS} = 0V
Gate-Source Leakage	I _{GSS}	-	±1	±100	nA	V _{GS} = ±40V, V _{DS} = 0V
ON CHARACTERISTICS						
Gate Threshold Voltage	V _{GS(TH)}	-0.8	-1.5	-2.0	V	V _{DS} = V _{GS} , I _D = -1mA
Static Drain-Source On-Resistance (Note 8)	R _{DS(ON)}	-	10	14	Ω	V _{GS} = -10V, I _D = -200mA
		-	13	18	Ω	V _{GS} = -3.5V, I _D = -100mA
Forward Transconductance (Note 10)	g _{fs}	80	200	-	mS	V _{DS} = -10V, I _D = -0.15A
Diode Forward Voltage (Note 8)	V _{SD}	-	-	0.97	V	I _S = -200mA, V _{GS} = 0V, T _J = +25°C
DYNAMIC CHARACTERISTICS						
Input Capacitance (Note 10)	C _{iss}	-	73	-	pF	V _{DS} = -25V, V _{GS} = 0V, f = 1.0MHz
Output Capacitance (Note 10)	C _{oss}	-	12.8	-	pF	
Reverse Transfer Capacitance (Note 10)	C _{rss}	-	3.91	-	pF	
Total Gate Charge (Notes 9 & 10)	Q _g	-	2.45	3.45	nC	V _{GS} = -10V, V _{DS} = -25V I _D = -200mA
Gate-Source Charge (Notes 9 & 10)	Q _{gs}	-	0.22	0.31	nC	
Gate-Drain Charge (Notes 9 & 10)	Q _{gd}	-	0.45	0.63	nC	
Turn-On Delay Time (Notes 9 & 10)	t _{D(ON)}	-	1.53	-	ns	V _{DD} = -30V, I _D = -200mA, V _{GS} = -10V, R _G = 50Ω
Turn-On Rise Time (Notes 9 & 10)	t _R	-	3.78	-	ns	
Turn-Off Delay Time (Notes 9 & 10)	t _{D(OFF)}	-	17.5	-	ns	
Turn-Off Fall Time (Notes 9 & 10)	t _F	-	7.85	-	ns	
Reverse Recovery Time (Note 10)	t _{RR}	-	205	290	ns	I _F = -200mA, di/dt = 100A/μs, T _J = +25°C
Reverse Recovery Charge (Note 10)	Q _{rr}	-	21	29	nC	

- Notes:
- For a device surface mounted on 25mm x 25mm FR4 PCB with high coverage of single sided 1oz copper, in still air conditions.
 - For a device surface mounted on FR4 PCB measured at t ≤ 5 secs.
 - Repetitive rating 25mm x 25mm FR4 PCB, D=0.02 pulse width=300μs - pulse width limited by maximum junction temperature.
 - Measured under pulsed conditions. Pulse width ≤ 300μs; duty cycle ≤ 2%.
 - Switching characteristics are independent of operating junction temperature.
 - For design aid only, not subject to production testing.

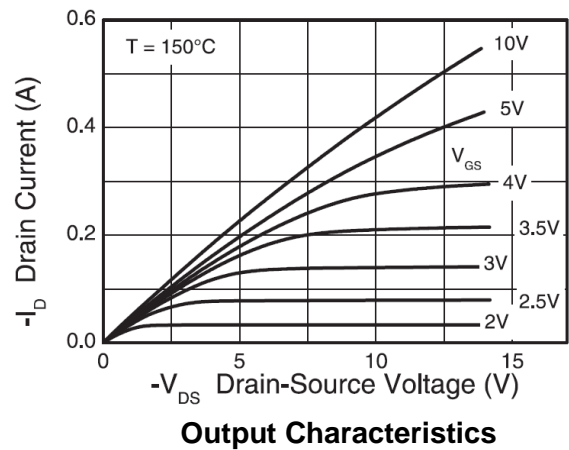
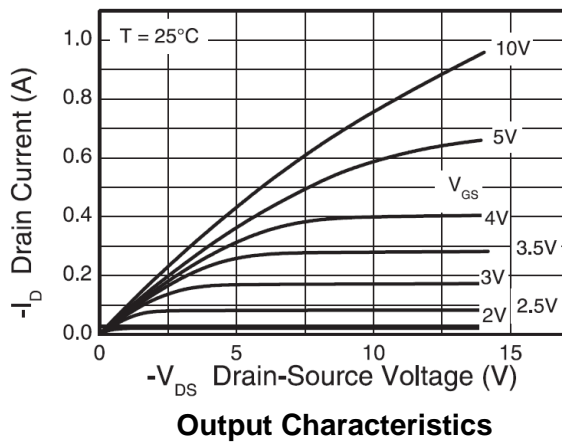

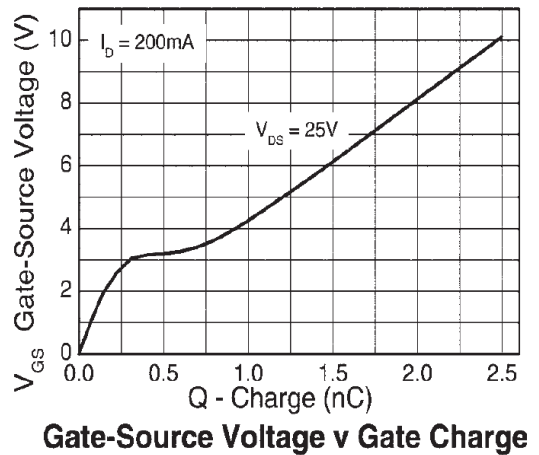
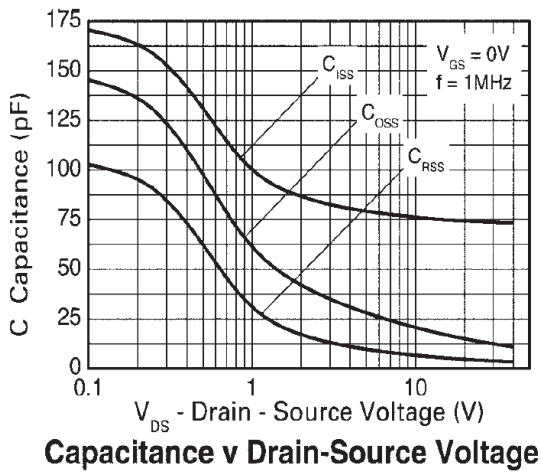
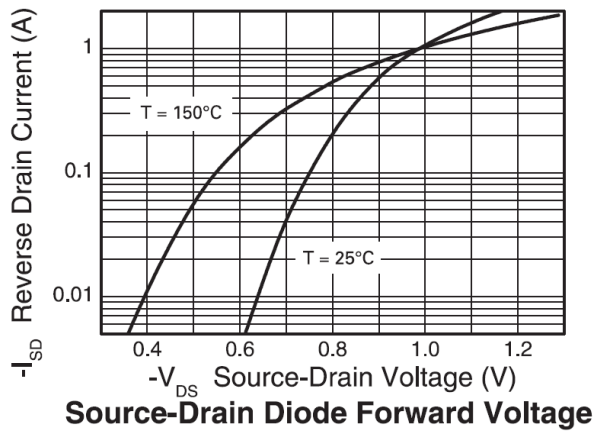
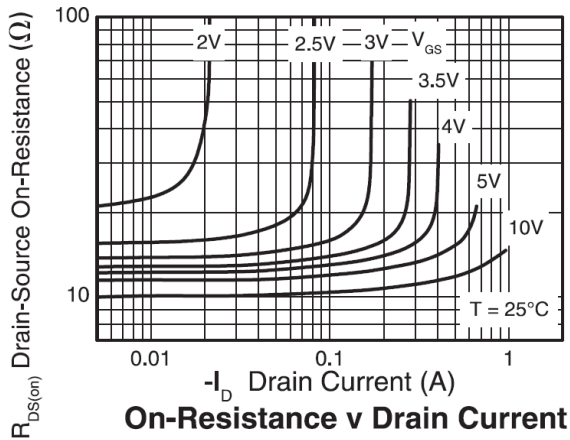
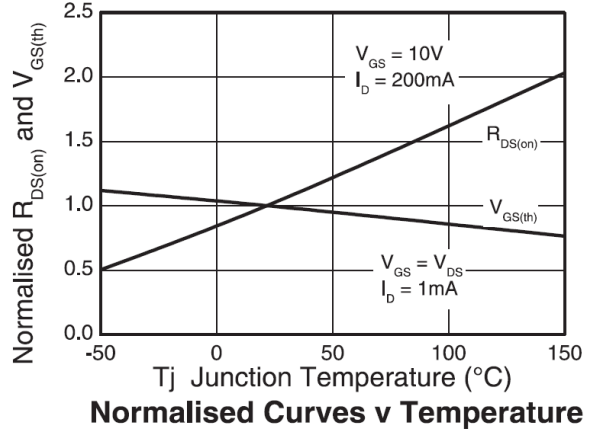
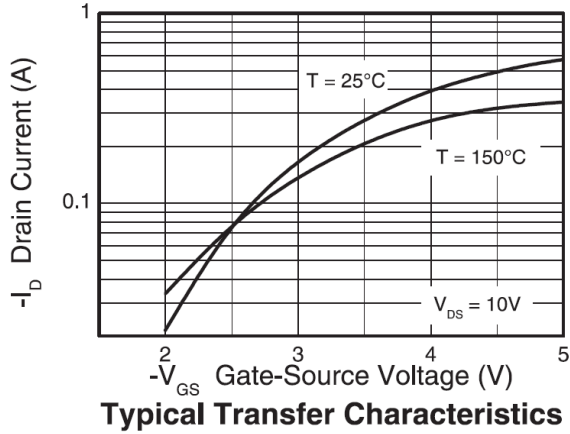

Test Circuits

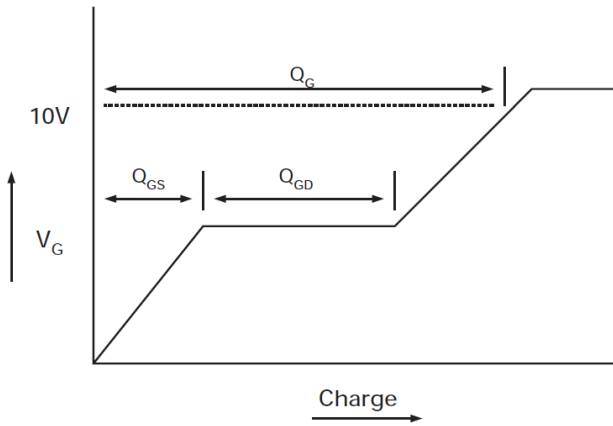

Basic Gate Charge Waveform

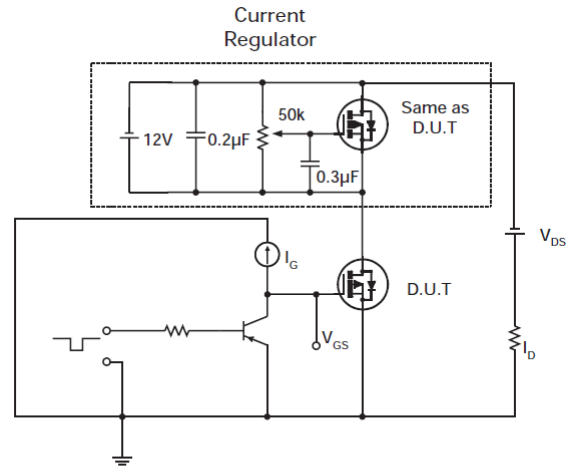

Gate Charge Test Circuit

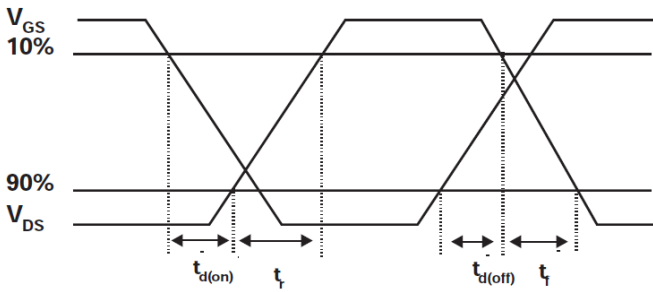

Switching Time Waveforms

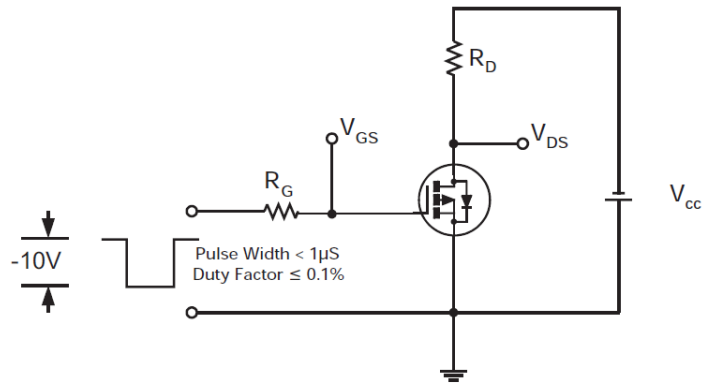

Switching Time Test Circuit

Package Outline Dimensions

Please see AP02002 at <http://www.diodes.com/datasheets/ap02002.pdf> for the latest version.

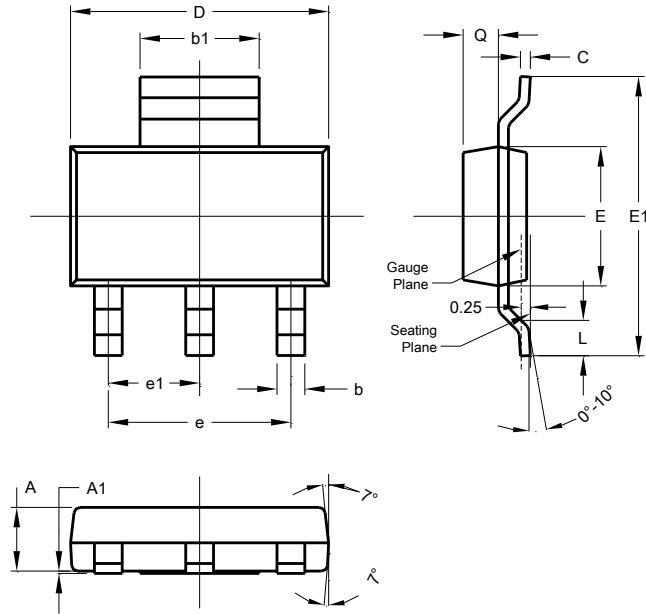

SOT223			
Dim	Min	Max	Typ
A	1.55	1.65	1.60
A1	0.010	0.15	0.05
b	0.60	0.80	0.70
b1	2.90	3.10	3.00
C	0.20	0.30	0.25
D	6.45	6.55	6.50
E	3.45	3.55	3.50
E1	6.90	7.10	7.00
e	-	-	4.60
e1	-	-	2.30
L	0.85	1.05	0.95
Q	0.84	0.94	0.89
All Dimensions in mm			

Suggested Pad Layout

Please see AP02001 at <http://www.diodes.com/datasheets/ap02001.pdf> for the latest version.

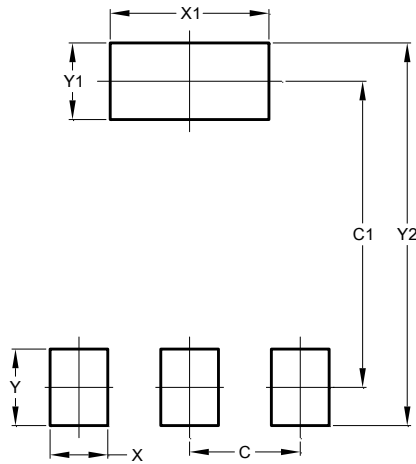

Dimensions	Value (in mm)
C	2.30
C1	6.40
X	1.20
X1	3.30
Y	1.60
Y1	1.60
Y2	8.00

IMPORTANT NOTICE

DIODES INCORPORATED MAKES NO WARRANTY OF ANY KIND, EXPRESS OR IMPLIED, WITH REGARDS TO THIS DOCUMENT, INCLUDING, BUT NOT LIMITED TO, THE IMPLIED WARRANTIES OF MERCHANTABILITY AND FITNESS FOR A PARTICULAR PURPOSE (AND THEIR EQUIVALENTS UNDER THE LAWS OF ANY JURISDICTION).

Diodes Incorporated and its subsidiaries reserve the right to make modifications, enhancements, improvements, corrections or other changes without further notice to this document and any product described herein. Diodes Incorporated does not assume any liability arising out of the application or use of this document or any product described herein; neither does Diodes Incorporated convey any license under its patent or trademark rights, nor the rights of others. Any Customer or user of this document or products described herein in such applications shall assume all risks of such use and will agree to hold Diodes Incorporated and all the companies whose products are represented on Diodes Incorporated website, harmless against all damages.

Diodes Incorporated does not warrant or accept any liability whatsoever in respect of any products purchased through unauthorized sales channel. Should Customers purchase or use Diodes Incorporated products for any unintended or unauthorized application, Customers shall indemnify and hold Diodes Incorporated and its representatives harmless against all claims, damages, expenses, and attorney fees arising out of, directly or indirectly, any claim of personal injury or death associated with such unintended or unauthorized application.

Products described herein may be covered by one or more United States, international or foreign patents pending. Product names and markings noted herein may also be covered by one or more United States, international or foreign trademarks.

This document is written in English but may be translated into multiple languages for reference. Only the English version of this document is the final and determinative format released by Diodes Incorporated.

LIFE SUPPORT

Diodes Incorporated products are specifically not authorized for use as critical components in life support devices or systems without the express written approval of the Chief Executive Officer of Diodes Incorporated. As used herein:

A. Life support devices or systems are devices or systems which:

1. are intended to implant into the body, or
2. support or sustain life and whose failure to perform when properly used in accordance with instructions for use provided in the labeling can be reasonably expected to result in significant injury to the user.

B. A critical component is any component in a life support device or system whose failure to perform can be reasonably expected to cause the failure of the life support device or to affect its safety or effectiveness.

Customers represent that they have all necessary expertise in the safety and regulatory ramifications of their life support devices or systems, and acknowledge and agree that they are solely responsible for all legal, regulatory and safety-related requirements concerning their products and any use of Diodes Incorporated products in such safety-critical, life support devices or systems, notwithstanding any devices- or systems-related information or support that may be provided by Diodes Incorporated. Further, Customers must fully indemnify Diodes Incorporated and its representatives against any damages arising out of the use of Diodes Incorporated products in such safety-critical, life support devices or systems.

Copyright © 2015, Diodes Incorporated

www.diodes.com