

High and Low Side Driver

Features

- Floating channel designed for bootstrap operation
- Fully operational to 200V
- Tolerant to negative transient voltage, dV/dt immune
- Gate drive supply range from 10 to 20V
- Undervoltage lockout for both channels
- 3.3V logic compatible
- Separate logic supply range from 3.3V to 20V
- Logic and power ground +/-5V offset
- CMOS Schmitt-triggered inputs with pull-down
- Shut down input turns off both channels
- Cross-conduction prevention logic
- Matched propagation delay for both channels
- Outputs in phase with inputs

Description

The IR2010 is a high power, high voltage, high speed power MOSFET and IGBT driver with independent high and low side referenced output channels. Logic inputs are compatible with standard CMOS or LSTTL output, down to 3.0V logic. The output drivers feature a high pulse current buffer stage designed for minimum driver cross-conduction. Propagation delays are matched to simplify use in high frequency applications. The floating channel can be used to drive an N-channel power MOSFET or IGBT in the high side configuration which operates up to 200 volts. Proprietary HVIC and latch immune CMOS technologies enable ruggedized monolithic construction.

Applications

- Converters
- DC motor drive

Product Summary

V_{OFFSET} (max)	200V
$I_{\text{O+/-}}$ (typ)	3.0A / 3.0A
V_{OUT}	10 – 20V
$t_{\text{on/off}}$ (typ)	95ns & 65ns
Delay Matching (max)	15ns

Package Options

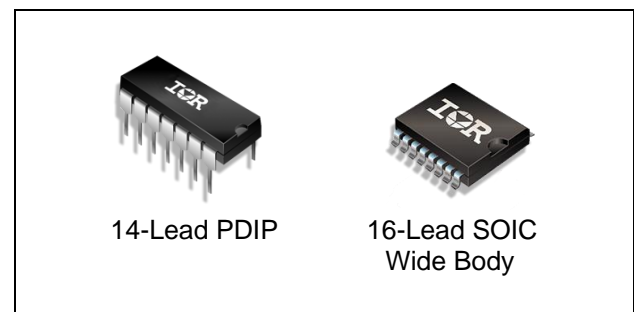

Ordering Information

Base Part Number	Package Type	Standard Pack		Orderable Part Number
		Form	Quantity	
IR2010PBF	PDIP14	Tube	25	IR2010PBF
IR2010SPBF	SO16W	Tube	45	IR2010SPBF
IR2010SPBF	SO16W	Tape and Reel	1000	IR2010STRPBF

Typical Connection Diagram

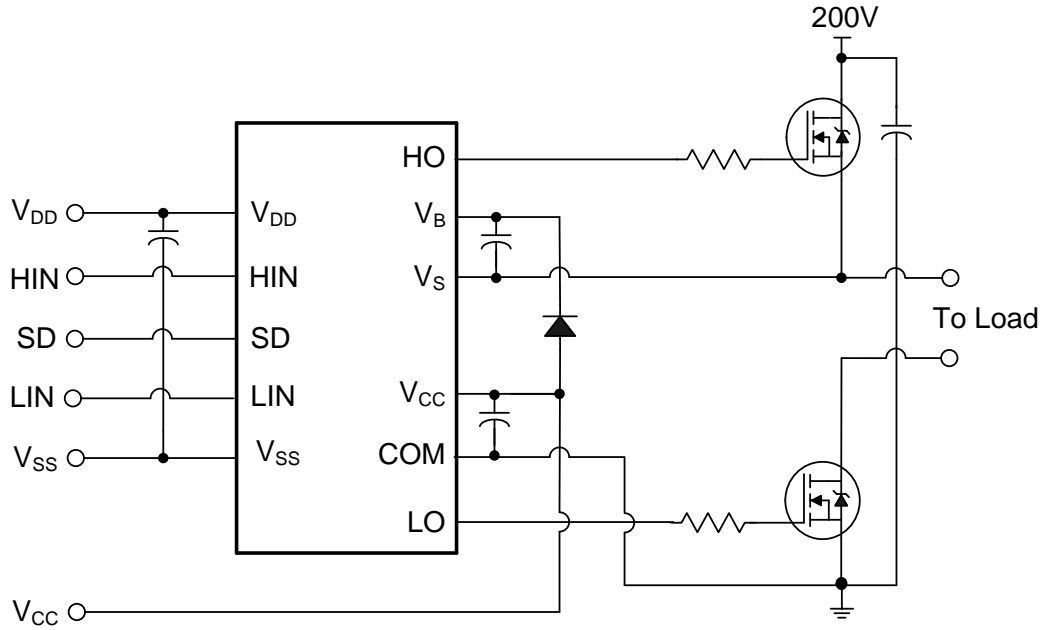

(Refer to Lead Assignments for correct configuration.) This diagram shows electrical connections only. Please refer to our Application Notes and Design Tips for proper circuit board layout

Absolute Maximum Ratings

Absolute maximum ratings indicate sustained limits beyond which damage to the device may occur. All voltage parameters are absolute voltages referenced to COM. The thermal resistance and power dissipation ratings are measured under board mounted and still air conditions.

Symbol	Definition	Min.	Max.	Units	
V_B	High side floating supply voltage	-0.3	225	V	
V_S	High side floating supply offset voltage	$V_B - 25$	$V_B + 0.3$		
V_{HO}	High side floating output voltage	$V_S - 0.3$	$V_B + 0.3$		
V_{CC}	Low side fixed supply voltage	-0.3	25		
V_{LO}	Low side output voltage	-0.3	$V_{CC} + 0.3$		
V_{DD}	Logic supply voltage	-0.3	$V_{SS} + 25$		
V_{SS}	Logic supply offset voltage	$V_{CC} - 25$	$V_{CC} + 0.3$		
V_{IN}	Logic input voltage (HIN, LIN & SD)	$V_{SS} - 0.3$	$V_{DD} + 0.3$		
dV_S/dt	Allowable offset supply voltage transient (figure 2)	—	50	V/ns	
P_D	Package power dissipation @ $T_A \leq +25^\circ\text{C}$	14-Lead PDIP	—	1.6	W
		16-Lead SOIC	—	1.25	
R_{thJA}	Thermal resistance, junction to ambient	14-Lead PDIP	—	75	$^\circ\text{C}/\text{W}$
		16-Lead SOIC	—	100	
T_J	Junction temperature	—	150	$^\circ\text{C}$	
T_S	Storage temperature	-55	150		
T_L	Lead temperature (soldering, 10 seconds)	—	300		

Recommended Operating Conditions

The input/output logic timing diagram is shown in figure 1. For proper operation the device should be used within the recommended conditions. The V_S and V_{SS} offset rating is tested with all supplies biased at 15V differential. Typical ratings at other bias conditions are shown in figures 24 and 25.

Symbol	Definition	Min.	Max.	Units
V_B	High side floating supply absolute voltage	$V_S + 10$	$V_S + 20$	V
V_S	High side floating supply offset voltage	†	200	
V_{HO}	High side floating output voltage	V_S	V_B	
V_{CC}	Low side fixed supply voltage	10	20	
V_{LO}	Low side output voltage	0	V_{CC}	
V_{DD}	Logic supply voltage	$V_{SS} + 3$	$V_{SS} + 20$	
V_{SS}	Logic supply offset voltage	-5 ^{††}	5	
V_{IN}	Logic input voltage (HIN, LIN, & SD)	V_{SS}	V_{DD}	
T_A	Ambient temperature	-40	125	$^\circ\text{C}$

† Logic operational for V_S of -4 to +200V. Logic state held for V_S of -4V to $-V_{BS}$.

†† When $V_{DD} < 5\text{V}$, the minimum V_{SS} offset is limited to $-V_{DD}$
(Please refer to the Design Tip DT97-3 for more details).

Dynamic Electrical Characteristics

V_{BIAS} (V_{CC} , V_{BS} , V_{DD}) = 15V, C_L = 1000pF and T_A = 25°C and V_{SS} = COM unless otherwise specified. The dynamic electrical characteristics are measured using the test circuit shown in figure 3.

Symbol	Definition	Figure	Min.	Typ.	Max.	Units	Test Conditions
t_{on}	Turn-on propagation delay	7	50	95	135	ns	$V_S = 0V$
t_{off}	Turn-off propagation delay	8	30	65	105		$V_S = 200V$
t_{sd}	Shutdown propagation delay	9	35	70	105		
t_r	Turn-on rise time	10	—	10	20		
t_f	Turn-off fall time	11	—	15	25		
MT	Delay matching, HS & LS turn-on/off	6	—	—	15		

Static Electrical Characteristics

V_{BIAS} (V_{CC} , V_{BS} , V_{DD}) = 15V and T_A = 25°C and V_{SS} = COM unless otherwise specified. The V_{IN} , V_{TH} and I_{IN} parameters are referenced to V_{SS} and are applicable to all three logic input leads: HIN, LIN and SD. The V_O and I_O parameters are referenced to COM and are applicable to the respective output leads: HO or LO.

Symbol	Definition	Figure	Min.	Typ.	Max.	Units	Test Conditions
V_{IH}	Logic "1" input voltage	12	9.5	—	—	V	$V_{DD} = 15V$
V_{IL}	Logic "0" input voltage	13	—	—	6.0		$V_{DD} = 3.3V$
V_{IH}	Logic "1" input voltage	12	2	—	—		$I_O = 0A$
V_{IL}	Logic "0" input voltage	13	—	—	1		
V_{OH}	High level output voltage, $V_{BIAS} - V_O$	14	—	—	1.0	μA	$V_B = V_S = 200V$
V_{OL}	Low level output voltage, V_O	15	—	—	0.1		$V_{IN} = 0V$ or V_{DD}
I_{LK}	Offset supply leakage current	16	—	—	50		$V_{IN} = V_{DD}$
I_{QBS}	Quiescent V_{BS} supply current	17	—	70	210		$V_{IN} = 0V$
I_{QCC}	Quiescent V_{CC} supply current	18	—	100	230		
I_{QDD}	Quiescent V_{DD} supply current	19	—	1	5		
I_{IN+}	Logic "1" input bias current	20	—	20	40	V	
I_{IN-}	Logic "0" input bias current	21	—	—	1.0		
V_{BSUV+}	V_{BS} supply undervoltage positive going threshold	22	7.5	8.6	9.7		
V_{BSUV-}	V_{BS} supply undervoltage negative going threshold	23	7.0	8.2	9.4		
V_{CCUV+}	V_{CC} supply undervoltage positive going threshold	24	7.5	8.6	9.7	A	$V_O = 0V$, $V_{IN} = V_{DD}$ $PW \leq 10 \mu s$
V_{CCUV-}	V_{CC} supply undervoltage negative going threshold	25	7.0	8.2	9.4		$V_O = 15V$, $V_{IN} = 0V$ $PW \leq 10 \mu s$
I_{O+}	Output high short circuit pulsed current	26	2.5	3.0	—	A	
I_{O-}	Output low short circuit pulsed current	27	2.5	3.0	—		

Functional Block Diagram

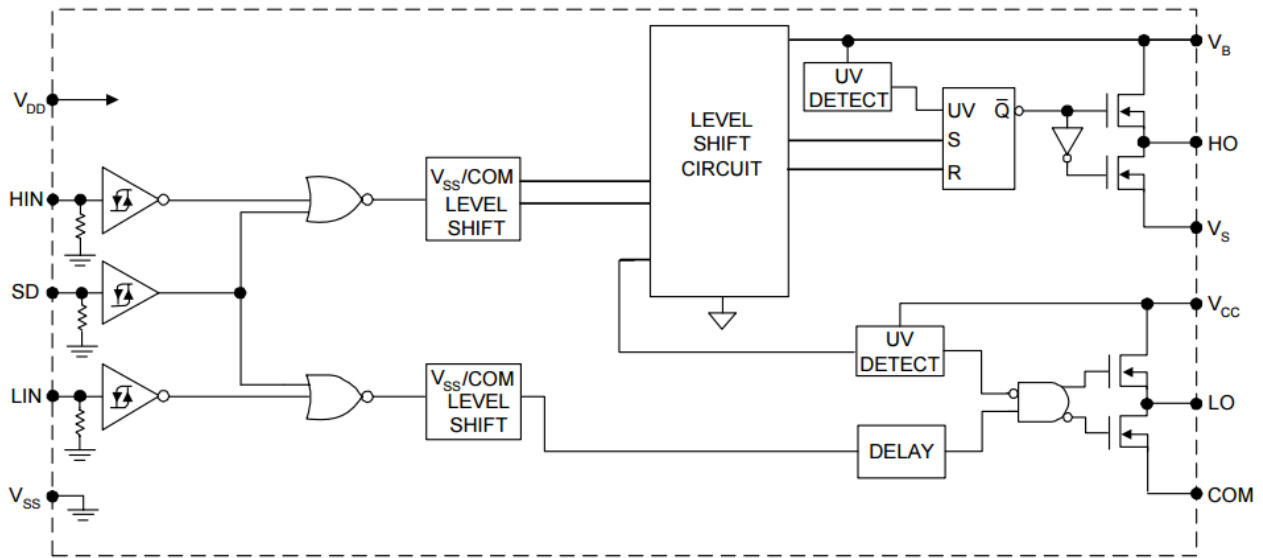

Lead Definitions

Symbol	Description
V _{DD}	Logic Supply
HIN	Logic input for high side gate driver outputs (HO), in phase
SD	Logic input for shutdown
LIN	Logic input for low side gate driver outputs (LO), in phase
V _{SS}	Logic ground
V _B	High side floating supply
HO	High side gate drive output
V _S	High side floating supply return
V _{CC}	Low side supply
LO	Low side gate drive output
COM	Low side return

Lead Assignments

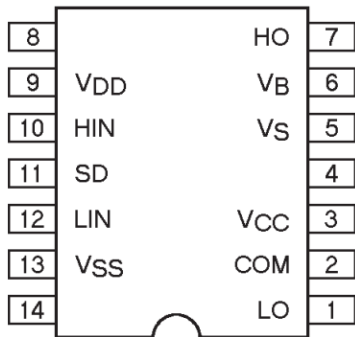

14-Lead PDIP

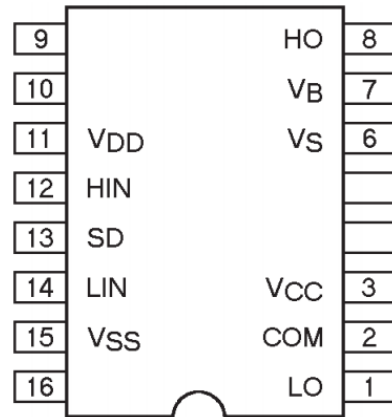

16-Lead SOIC (Wide Body)

Application Information and Additional Details

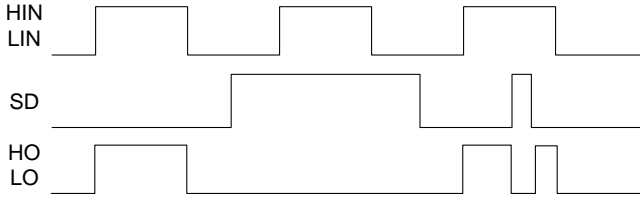

Figure 1. Input/Output Timing Diagram

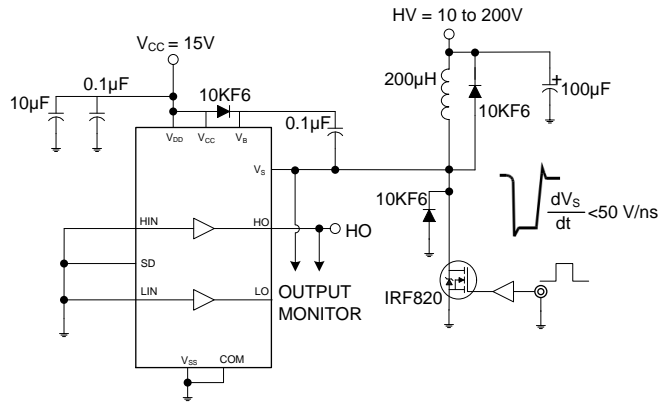

Figure 2. Floating Supply Voltage Transient Test Circuit

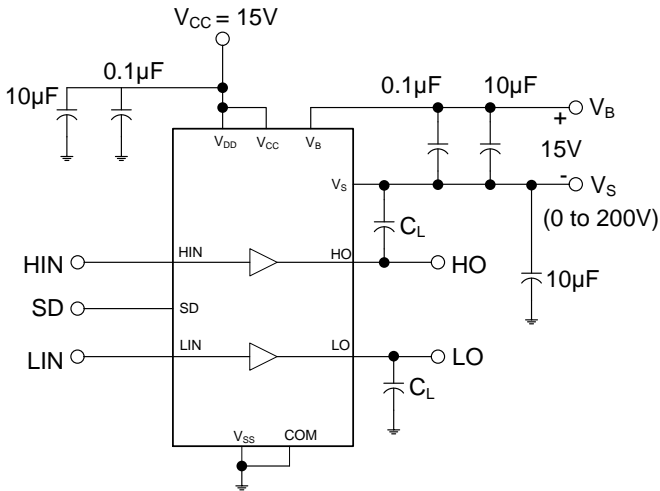

Figure 3. Switching Time Test Circuit

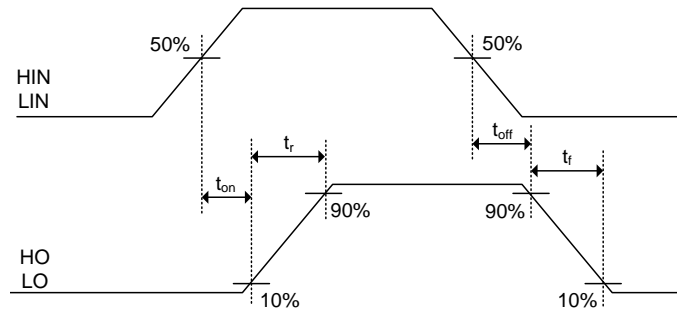

Figure 4. Switching Time Waveform Definition

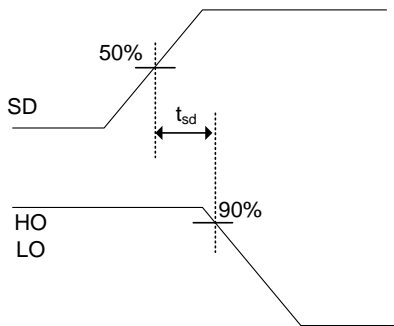

Figure 5. Shutdown Waveform Definitions

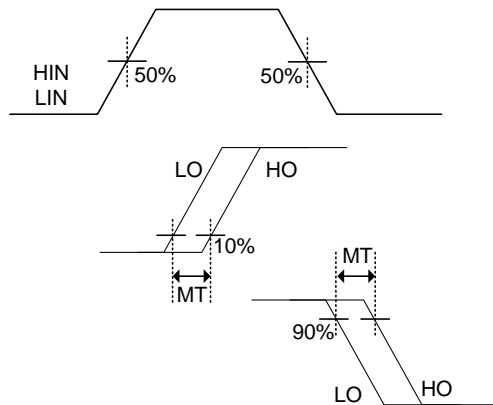

Figure 6. Delay Matching Waveform Definitions

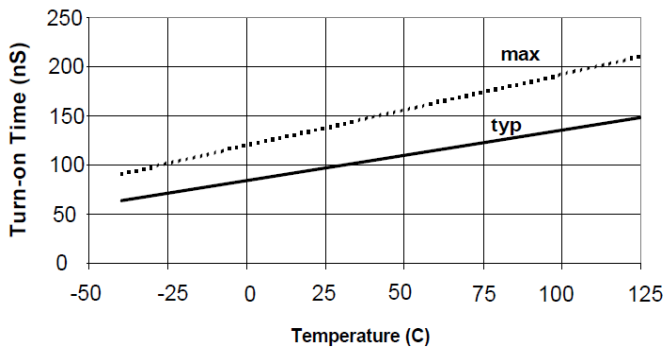

Figure 7A. Turn-on Time vs. Temperature

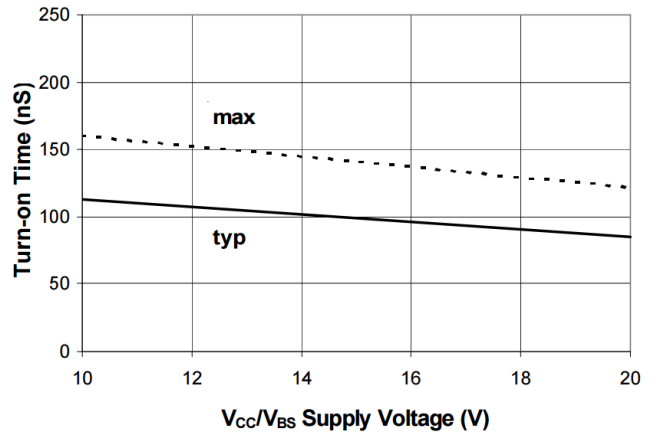

Figure 7B. Turn-on Time vs. V_{CC}/V_{BS} Voltage

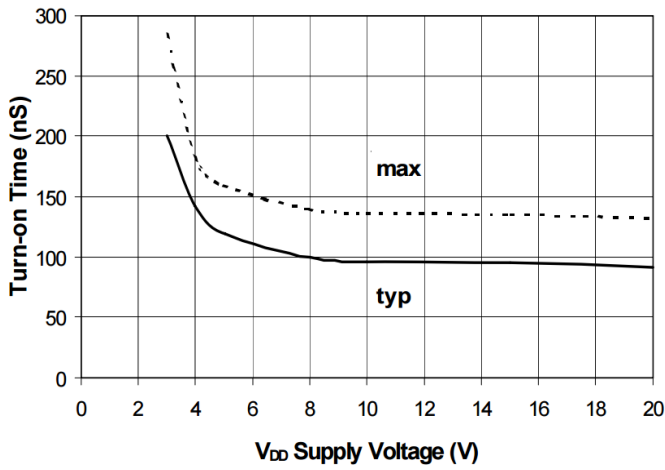

Figure 7C. Turn-on Time vs. V_{DD} Voltage

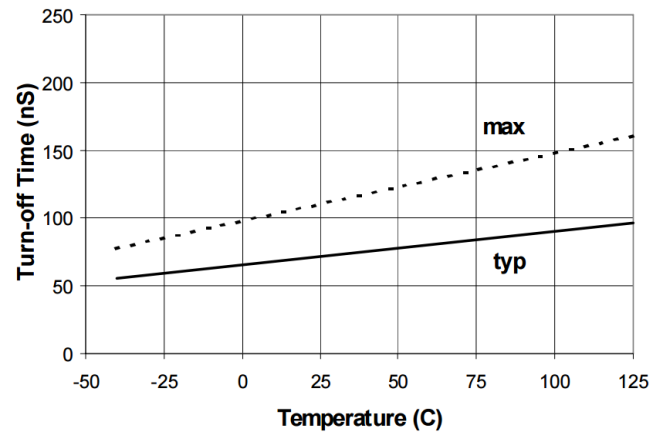

Figure 8A. Turn-off Time vs. Temperature

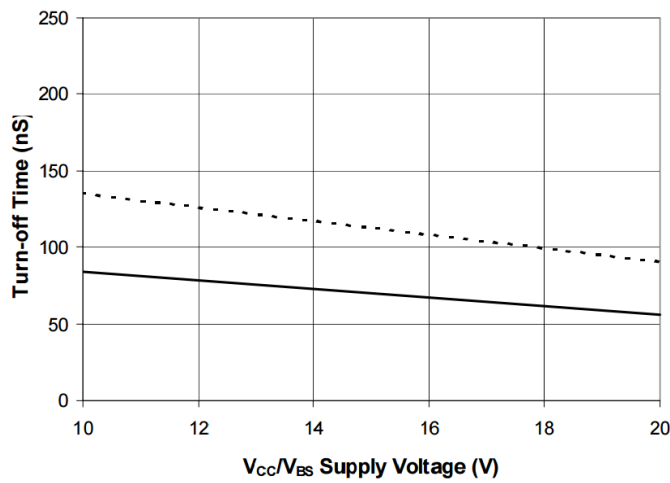

Figure 8B. Turn-off Time vs. V_{CC}/V_{BS} Voltage

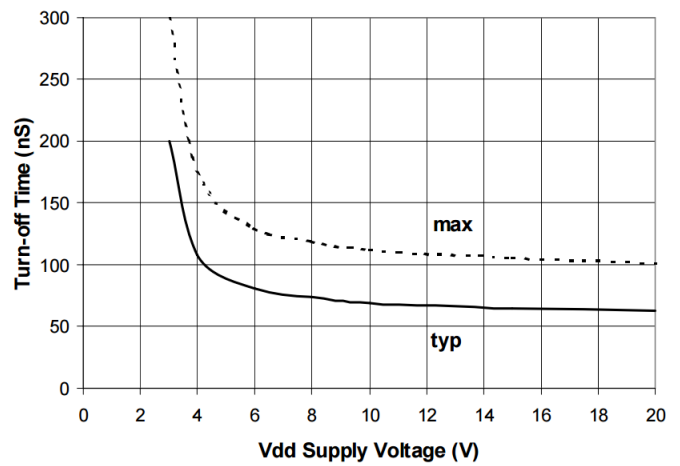

Figure 8C. Turn-off Time vs. V_{DD} Voltage

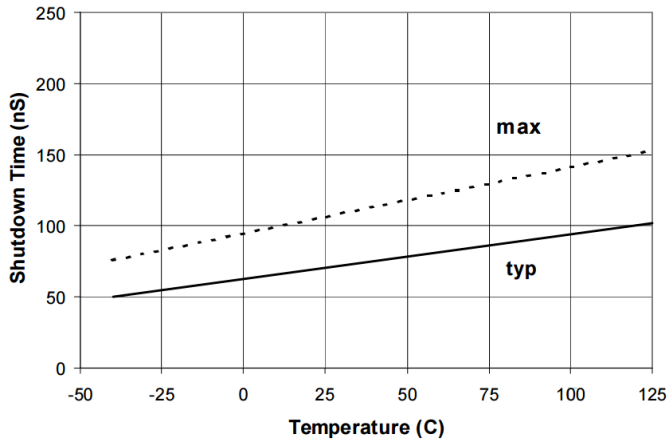

Figure 9A. Shutdown Time vs. Temperature

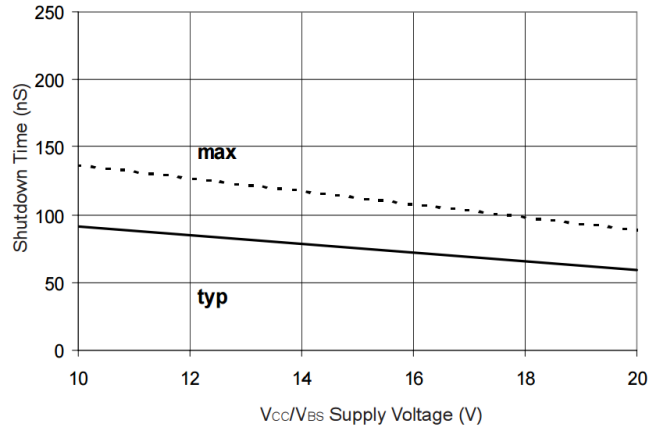

Figure 9B. Shutdown Time vs. V_{CC}/V_{BS} Voltage

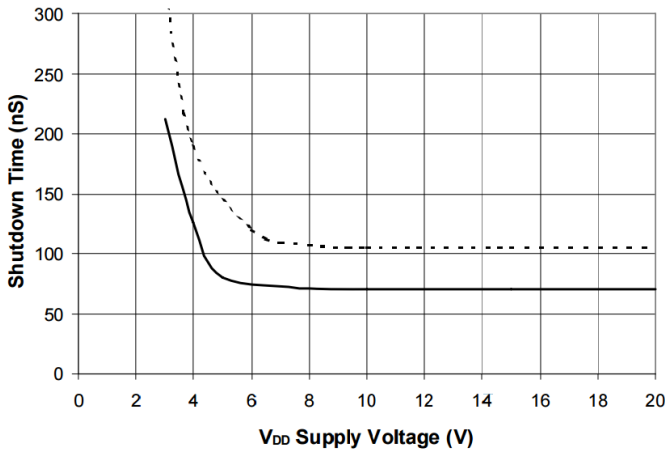

Figure 9C. Shutdown Time vs. V_{DD} Voltage

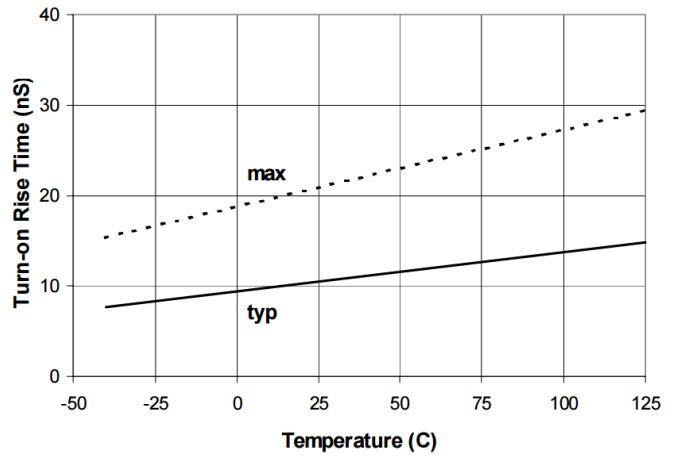

Figure 10A. Turn-on Rise Time vs. Temperature

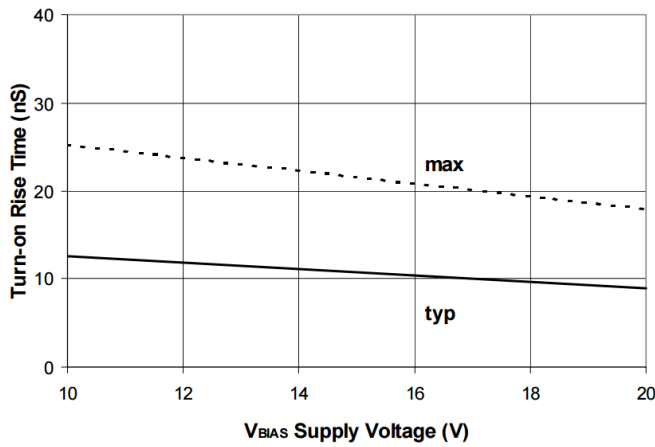

Figure 10B. Turn-on Rise Time vs. V_{BIAS} ($V_{CC}=V_{BS}=V_{DD}$) Voltage

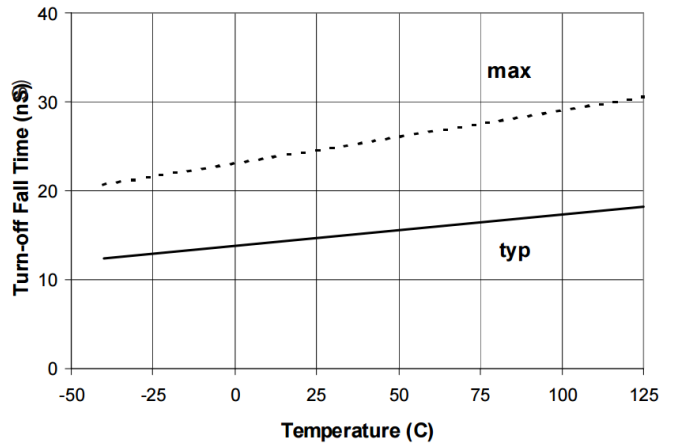

Figure 11A. Turn-off Fall Time vs. Temperature

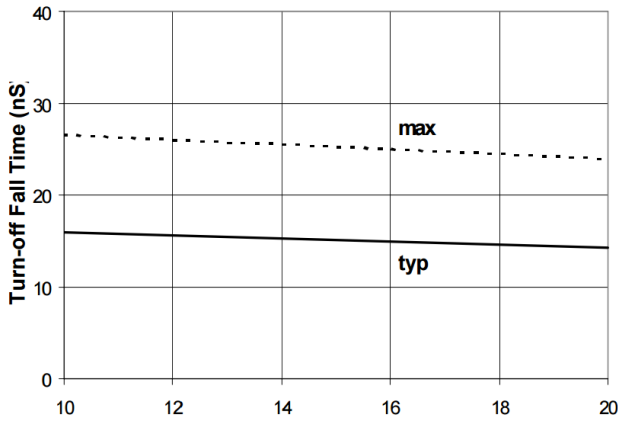

Figure 11B. Turn-Off Fall Time vs. V_{BIAS} ($V_{CC}=V_{BS}=V_{DD}$) Voltage

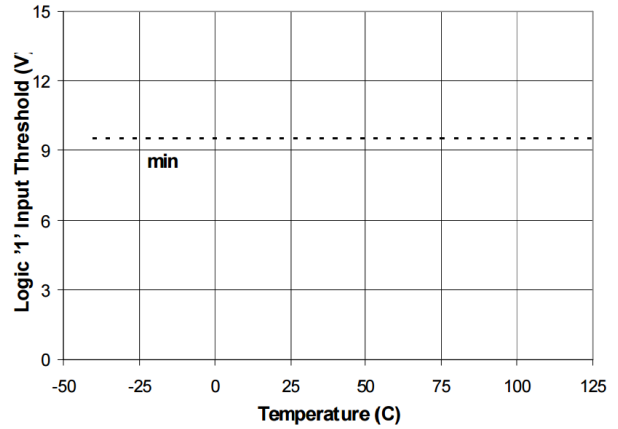

Figure 12A. Logic "1" Input Threshold vs. Temperature

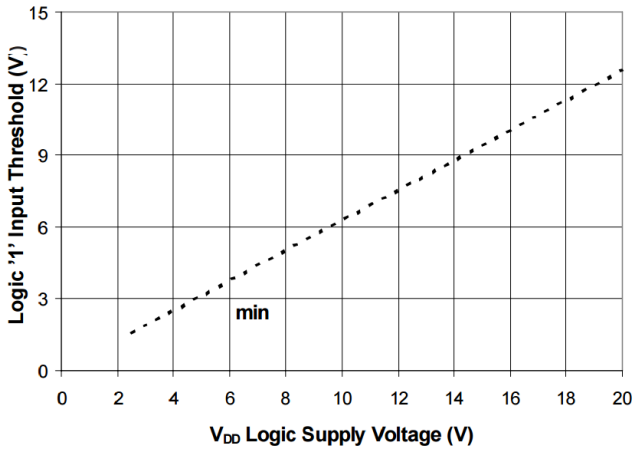

Figure 12B. Logic "1" Input Threshold vs. V_{DD} Voltage

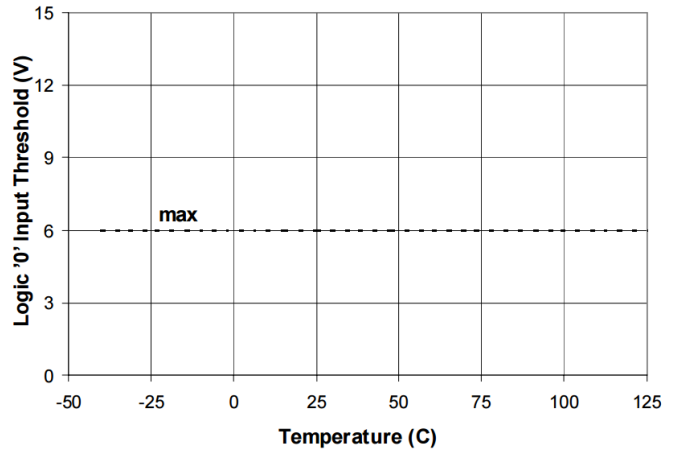

Figure 13A. Logic "0" Input Threshold vs. Temperature

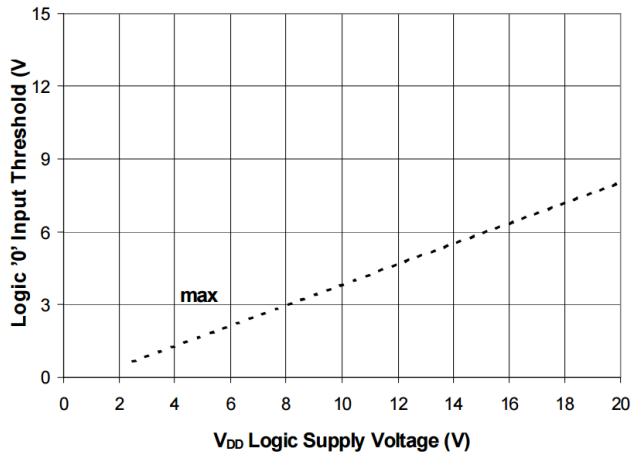

Figure 13B. Logic "0" Input Threshold vs. V_{DD} Voltage

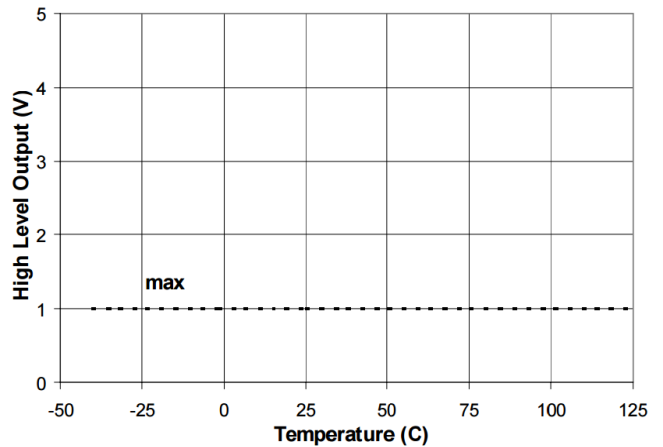

Figure 14A. High Level Output vs. Temperature

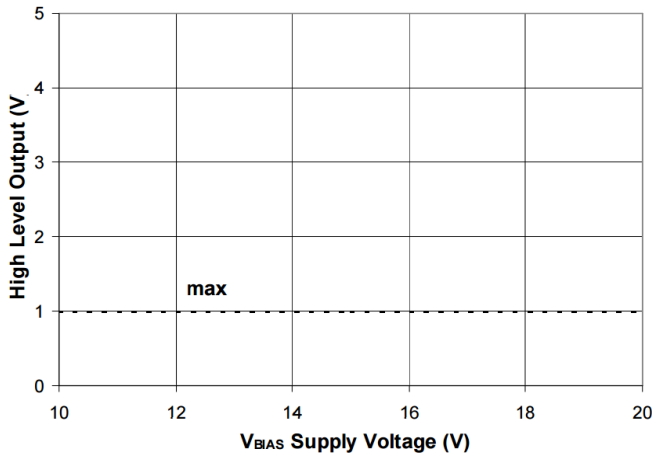

Figure 14B. High Level Output vs. V_{BIAS} Voltage

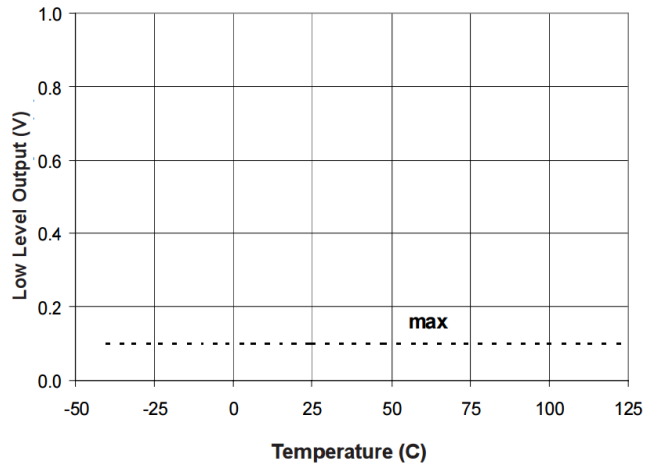

Figure 15A. Low Level Output vs. Temperature

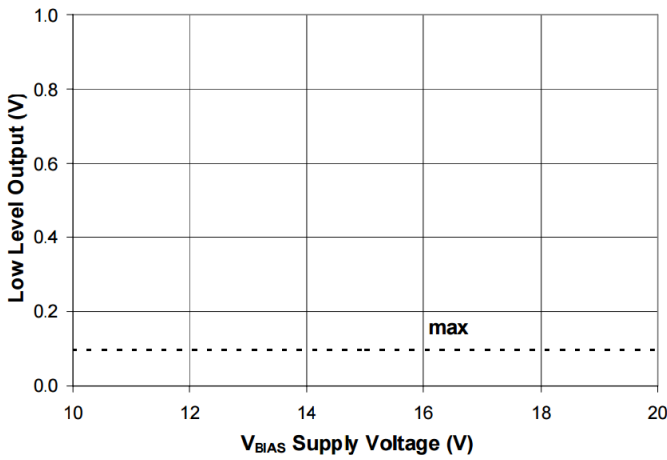

Figure 15B. Low Level Output vs. V_{BIAS} Voltage

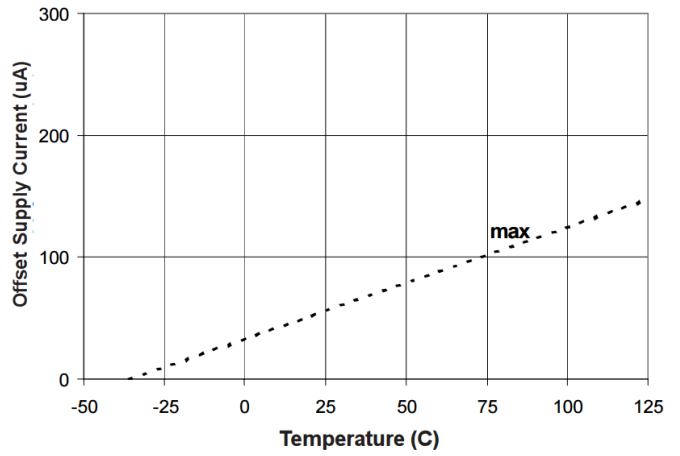

Figure 16A. Offset Supply Current vs. Temperature

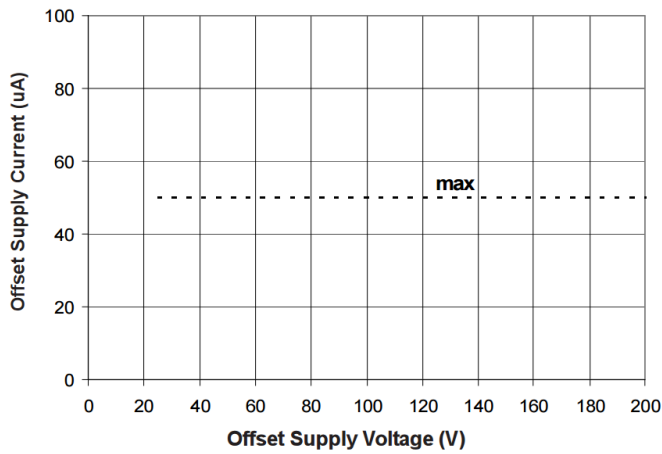

Figure 16B. Offset Supply Current vs. Offset Voltage

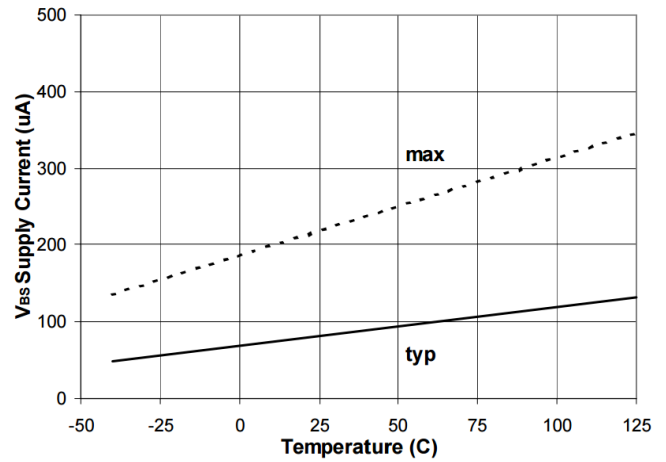

Figure 17A. V_{BS} Supply Current vs. Temperature

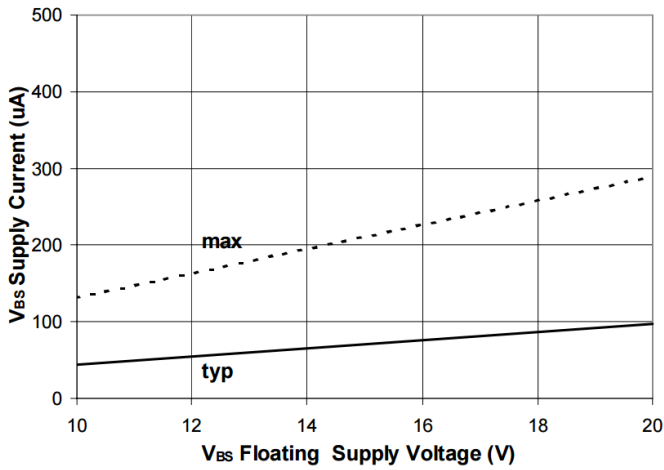

Figure 17B. V_{BS} Supply Current vs. V_{BS} Voltage

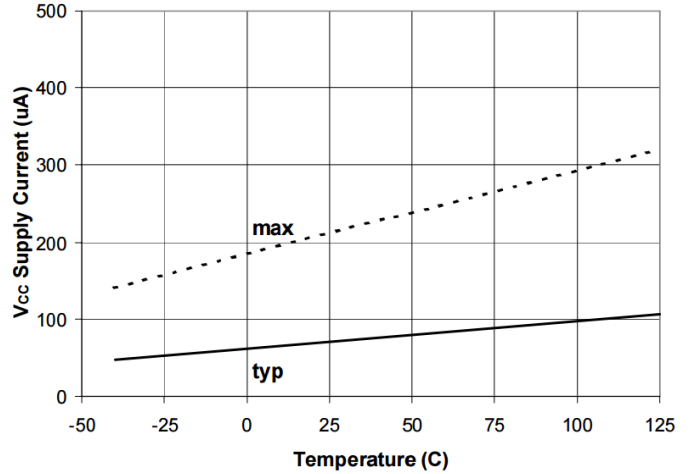

Figure 18A. V_{CC} Supply Current vs. Temperature

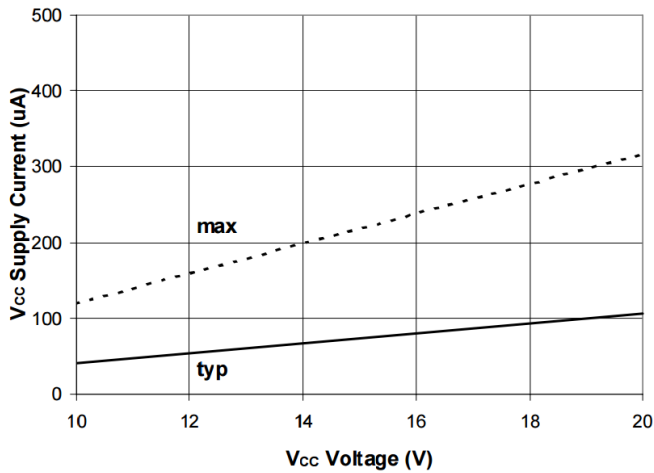

Figure 18B. V_{CC} Supply Current vs. V_{CC} Voltage

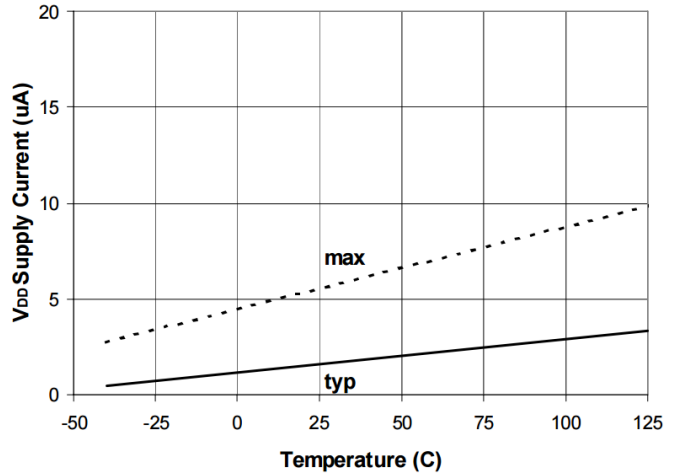

Figure 19A. V_{DD} Supply Current vs. Temperature

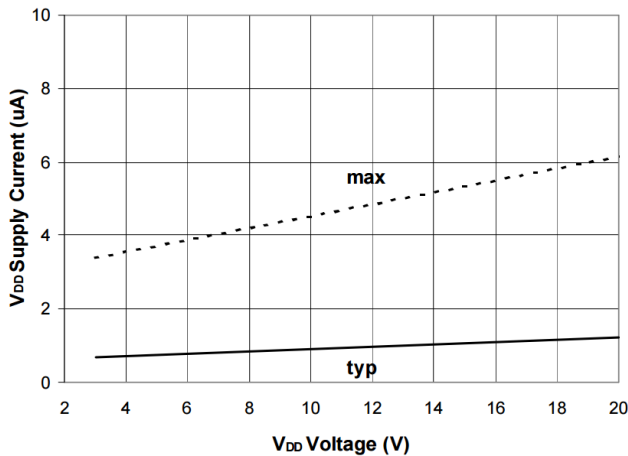

Figure 19B. V_{DD} Supply Current vs. V_{DD} Voltage

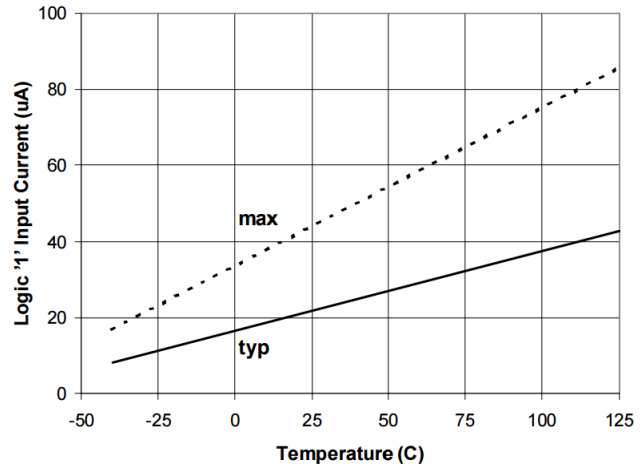

Figure 20A. Logic "1" Input Current vs. Temperature

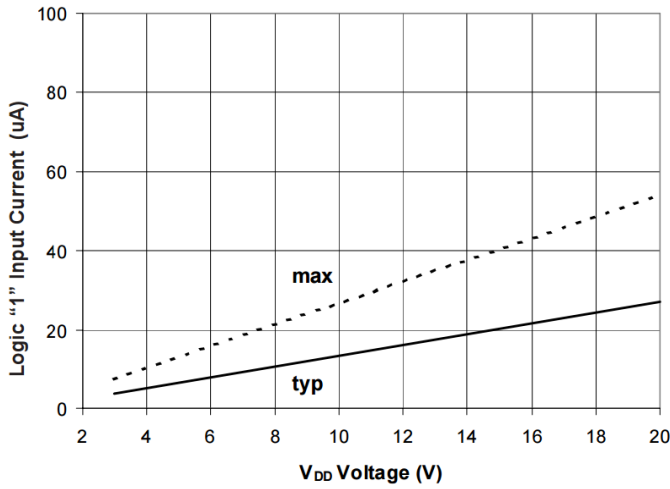

Figure 20B. Logic "1" Input Current vs. V_{DD} Voltage

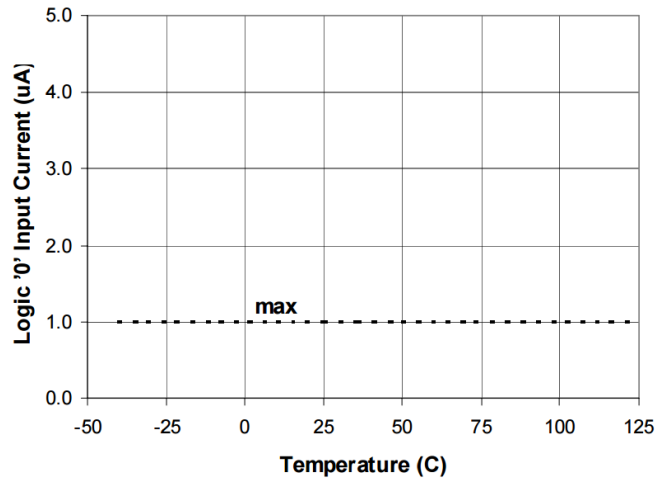

Figure 21A. Logic "0" Input Current vs. Temperature

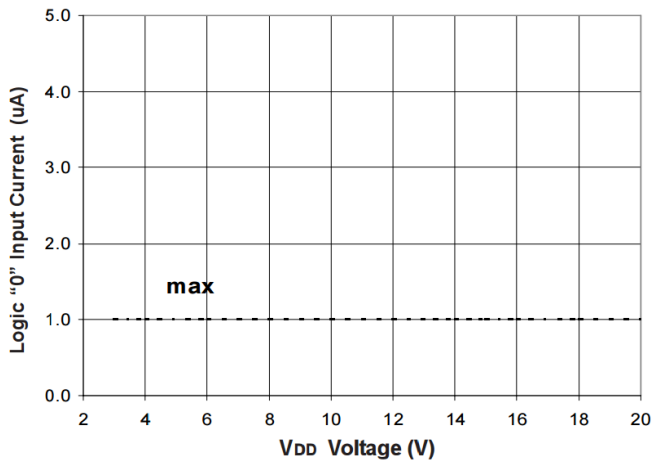

Figure 21B. Logic "0" Input Current vs. V_{DD} Voltage

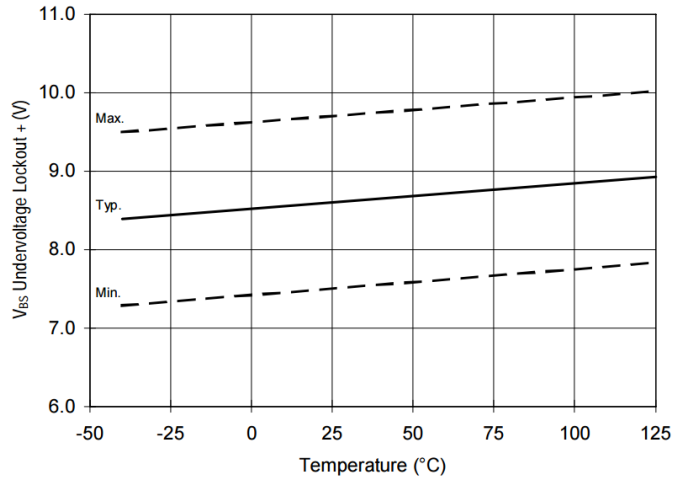

Figure 22. V_{BS} Undervoltage (+) vs. Temperature

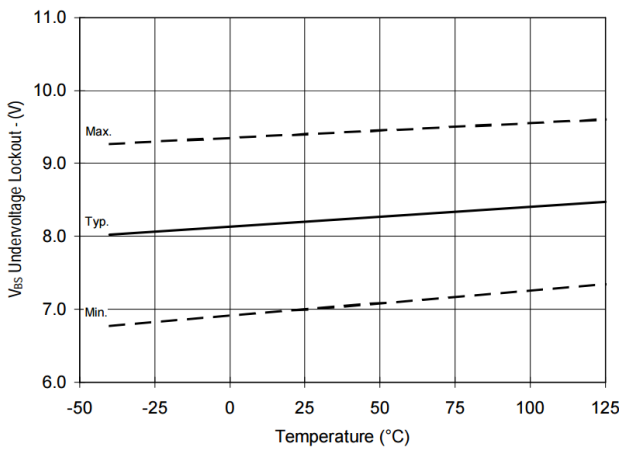

Figure 23. V_{BS} Undervoltage (-) vs. Temperature

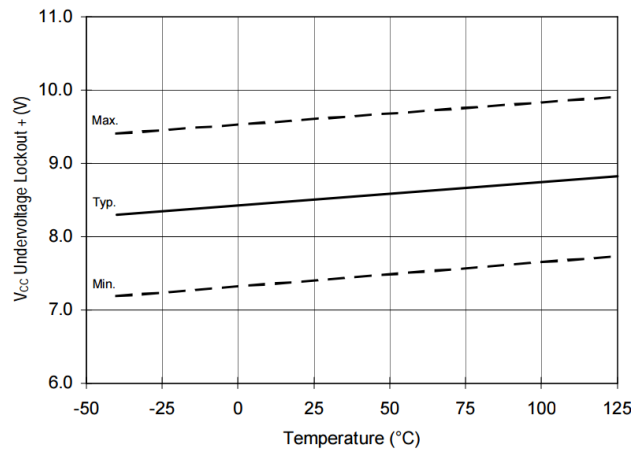

Figure 24. V_{CC} Undervoltage (+) vs. Temperature

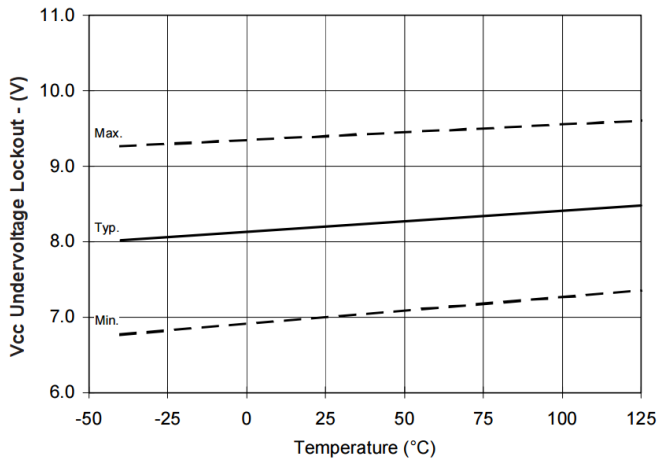

Figure 25. V_{CC} Undervoltage (-) vs. Temperature

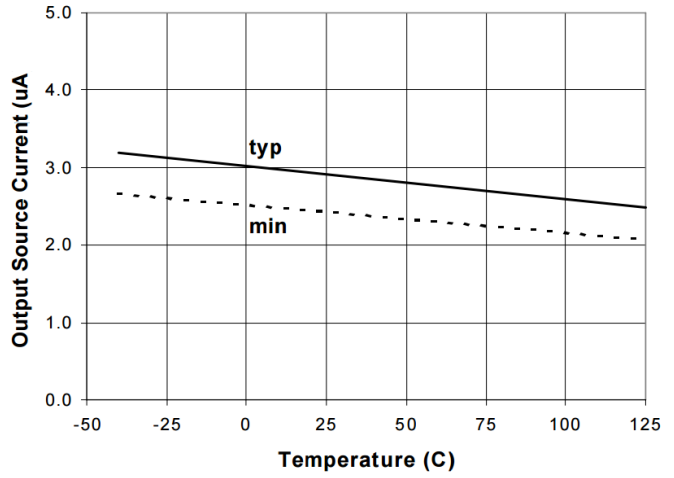

Figure 26A. Output Source Current vs. Temperature

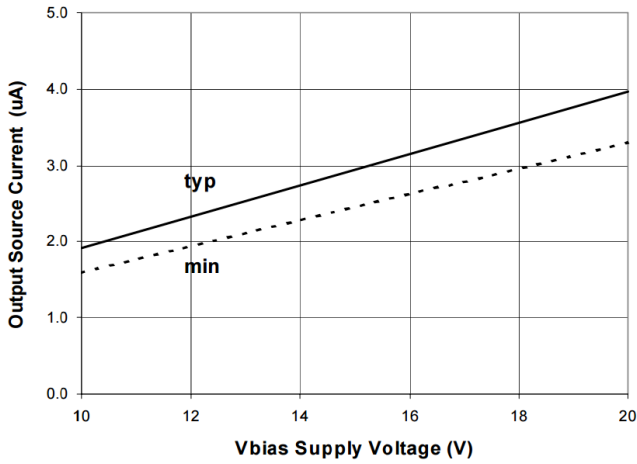

Figure 26B. Output Source Current vs. V_{BIAS} Voltage

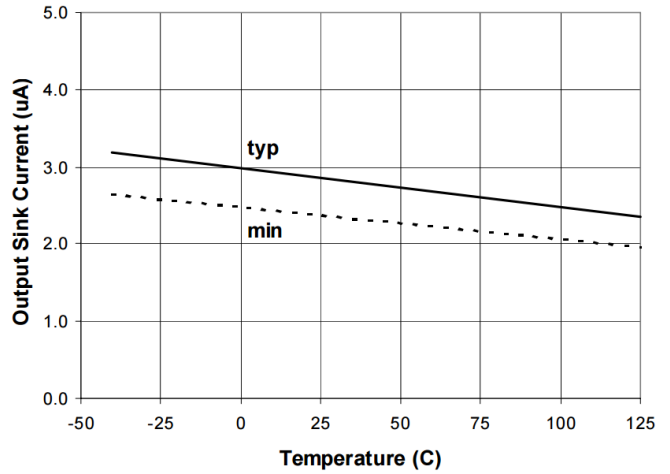

Figure 27A. Output Sink Current vs. Temperature

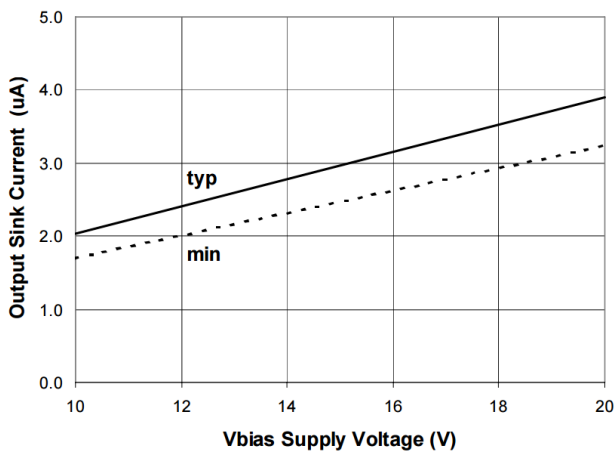

Figure 27B. Output Sink Current vs. V_{BIAS} Voltage

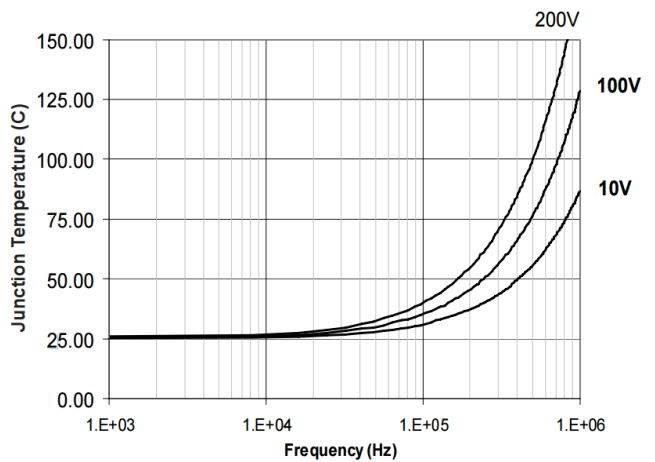

Figure 28. IR2010 T_j vs. Frequency
 $R_{GATE} = 10\Omega$, $V_{CC} = 15V$ with IRFPE50

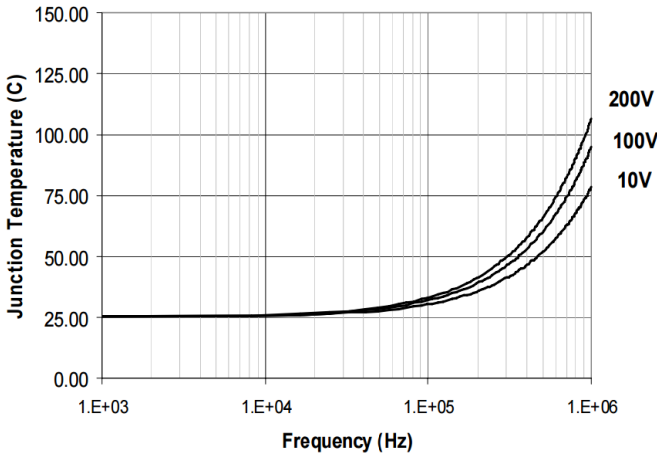

Figure 29. IR2010 Tj vs. Frequency
 $R_{GATE} = 16\Omega$, $V_{CC} = 15V$ with IRFBC40

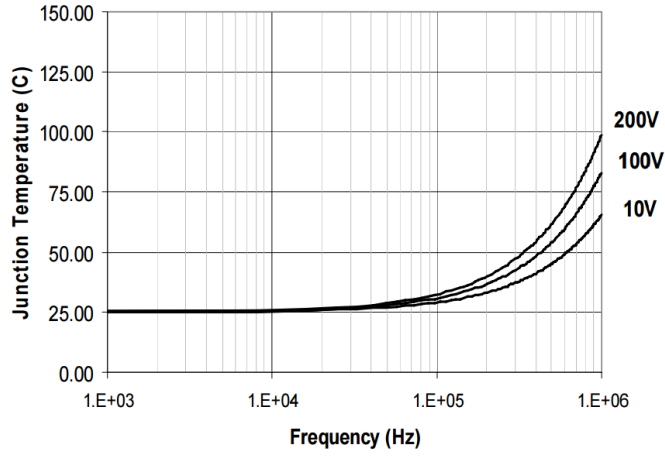

Figure 30. IR2010 Tj vs. Frequency
 $R_{GATE} = 22\Omega$, $V_{CC} = 15V$ with IRFBC30

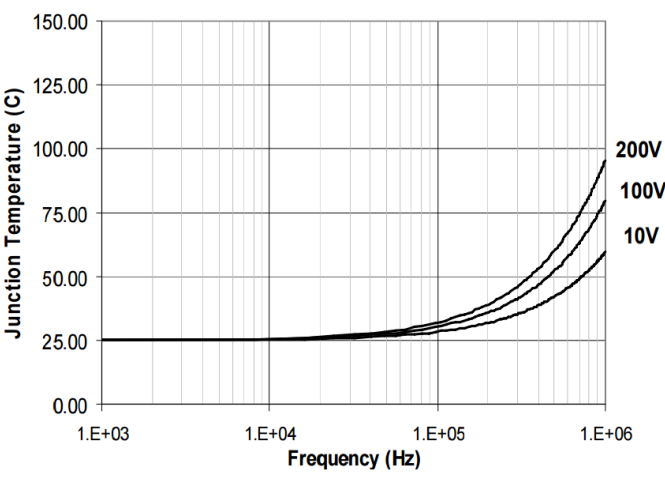

Figure 31. IR2010 Tj vs. Frequency
 $R_{GATE} = 33\Omega$, $V_{CC} = 15V$ with IRFBC20

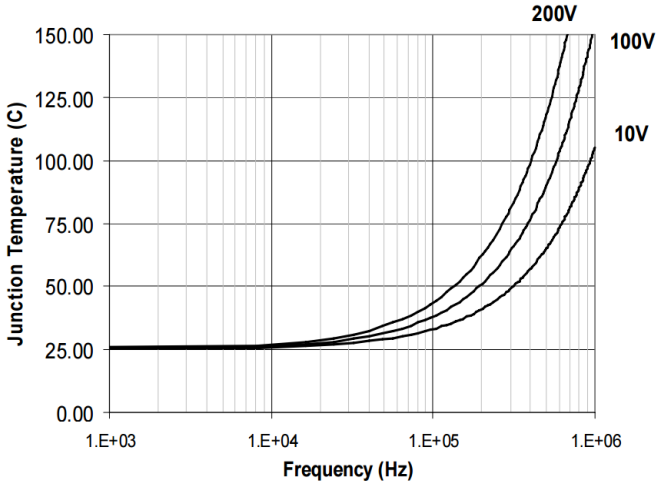

Figure 32. IR2010 Tj vs. Frequency
 $R_{GATE} = 10\Omega$, $V_{CC} = 15V$ with IRFBE50

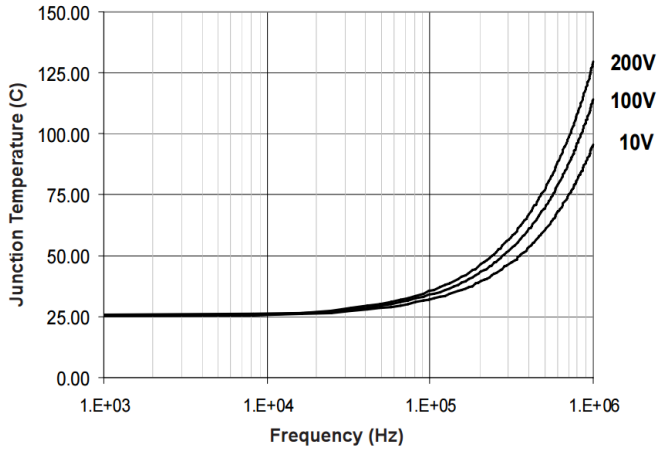

Figure 33. IR2010S Tj vs. Frequency
 $R_{GATE} = 16\Omega$, $V_{CC} = 15V$ with IRFBC40

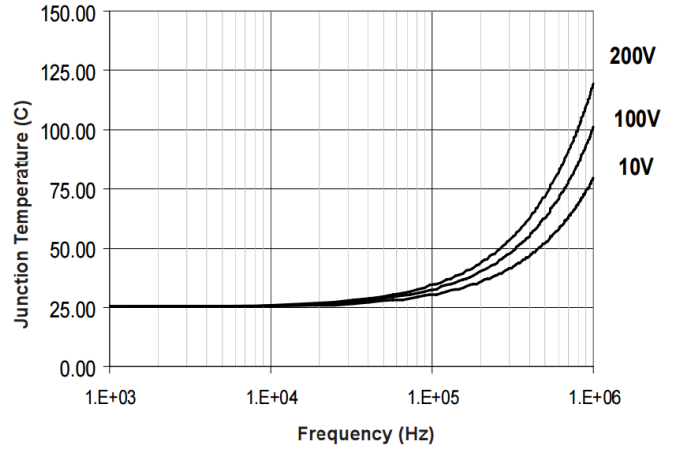

Figure 34. IR2010S Tj vs. Frequency
 $R_{GATE} = 22\Omega$, $V_{CC} = 15V$ with IRFBC30

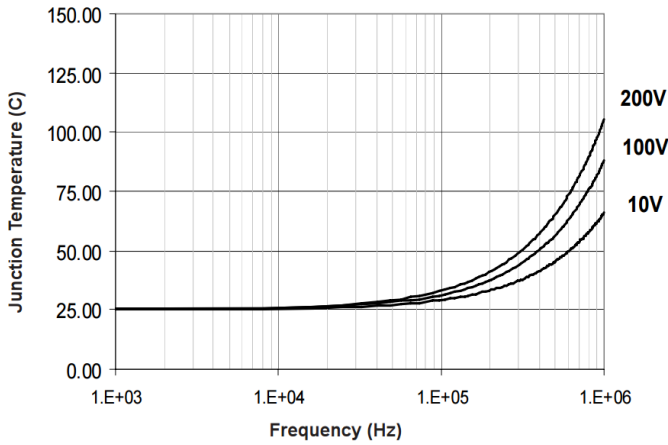
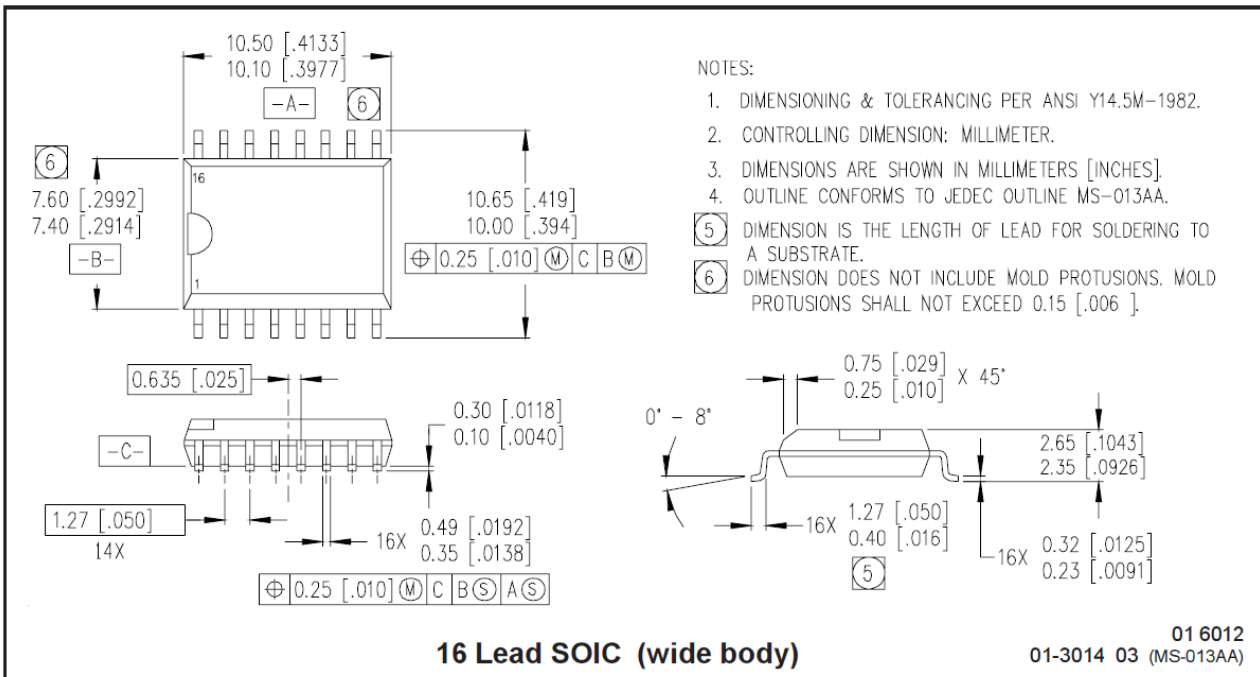
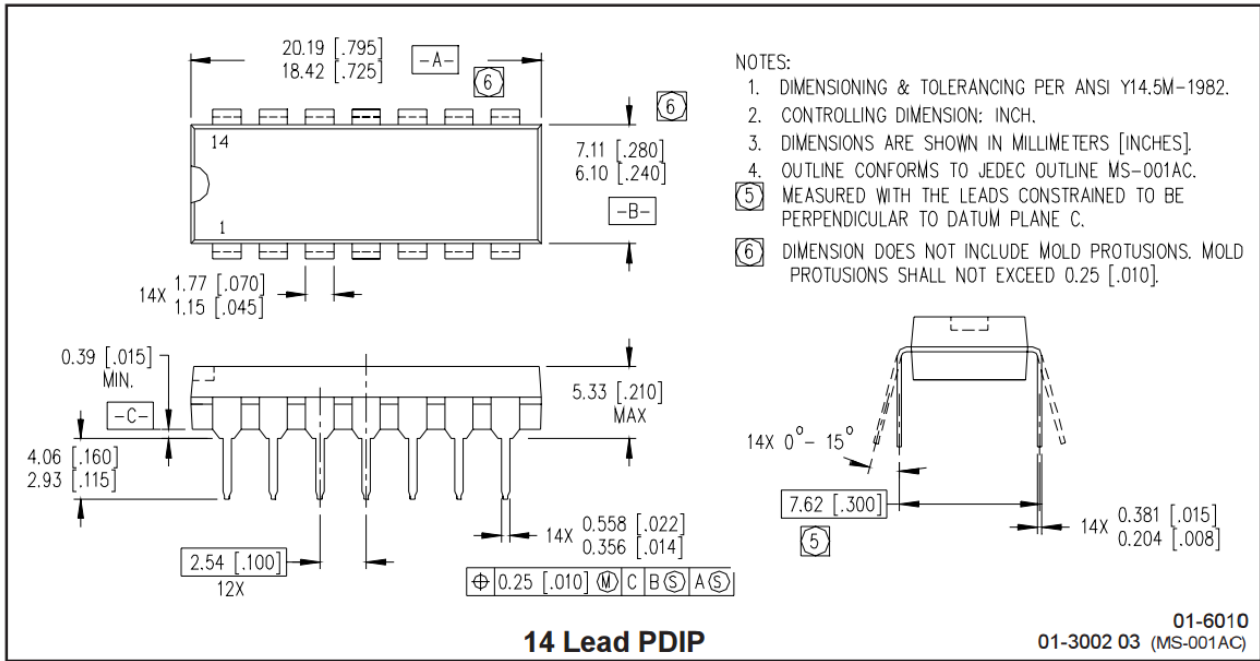
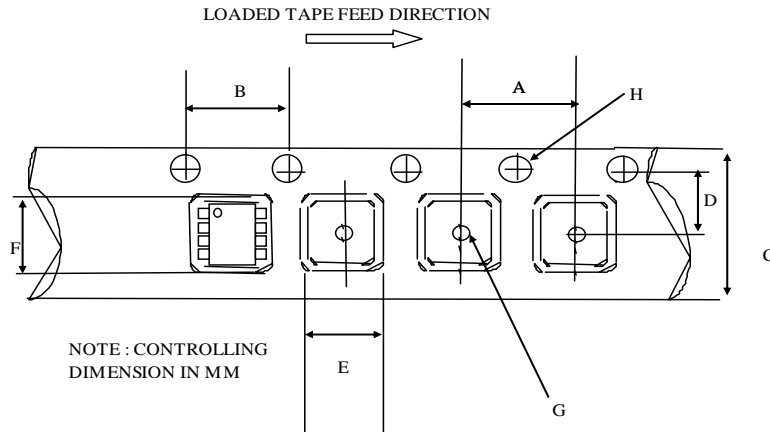

Figure 35. IR2010S Tj vs. Frequency
 $R_{GATE} = 33\Omega$, $V_{CC} = 15V$ with IRFBC20

Package Details



Tape and Reel Details



CARRIER TAPE DIMENSION FOR 16SOICW

Code	Metric		Imperial	
	Min	Max	Min	Max
A	11.90	12.10	0.468	0.476
B	3.90	4.10	0.153	0.161
C	15.70	16.30	0.618	0.641
D	7.40	7.60	0.291	0.299
E	10.80	11.00	0.425	0.433
F	10.60	10.80	0.417	0.425
G	1.50	n/a	0.059	n/a
H	1.50	1.60	0.059	0.062

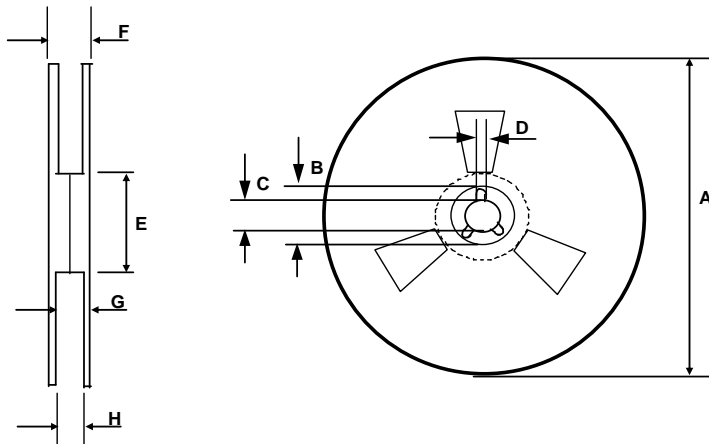

REEL DIMENSIONS FOR 16SOICW

Code	Metric		Imperial	
	Min	Max	Min	Max
A	329.60	330.25	12.976	13.001
B	20.95	21.45	0.824	0.844
C	12.80	13.20	0.503	0.519
D	1.95	2.45	0.767	0.096
E	98.00	102.00	3.858	4.015
F	n/a	22.40	n/a	0.881
G	18.50	21.10	0.728	0.830
H	16.40	18.40	0.645	0.724

Part Marking Information

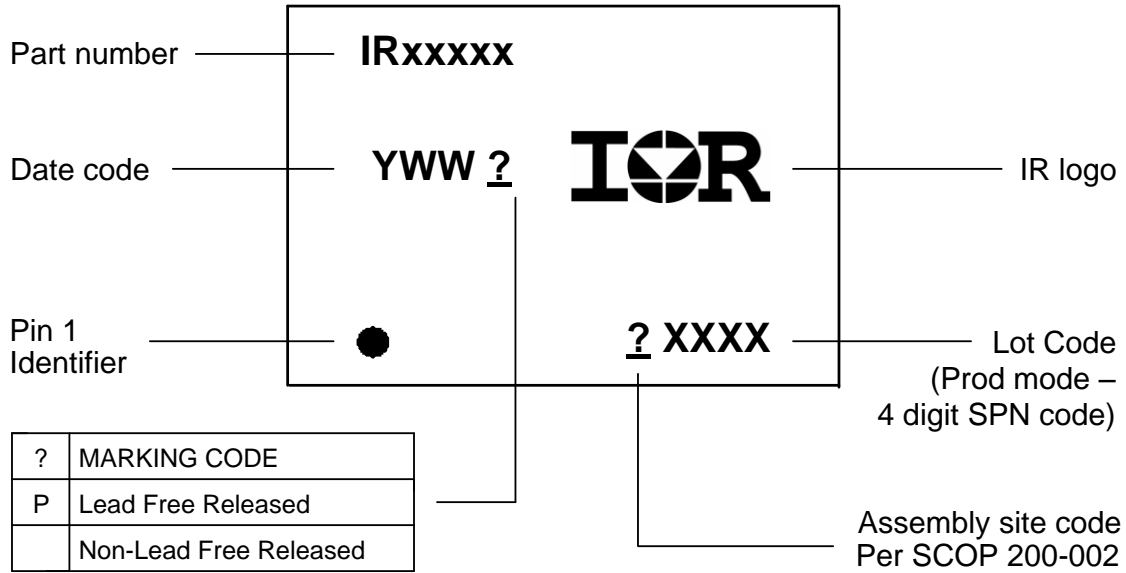

Qualification Information[†]

Qualification Level		Industrial ^{††} (per JEDEC JESD 47)
		Comments: This family of ICs has passed JEDEC's Industrial qualification. IR's Consumer qualification level is granted by extension of the higher Industrial level.
Moisture Sensitivity Level	16-Lead SOIC WB	MSL3 ^{†††} (per IPC/JEDEC J-STD-020)
RoHS Compliant		Yes

- † Qualification standards can be found at International Rectifier's web site <http://www.irf.com/>
- †† Higher qualification ratings may be available should the user have such requirements. Please contact your International Rectifier sales representative for further information.
- ††† Higher MSL ratings may be available for the specific package types listed here. Please contact your International Rectifier sales representative for further information.

The information provided in this document is believed to be accurate and reliable. However, International Rectifier assumes no responsibility for the consequences of the use of this information. International Rectifier assumes no responsibility for any infringement of patents or of other rights of third parties which may result from the use of this information. No license is granted by implication or otherwise under any patent or patent rights of International Rectifier. The specifications mentioned in this document are subject to change without notice. This document supersedes and replaces all information previously supplied.

For technical support, please contact IR's Technical Assistance Center
<http://www.irf.com/technical-info/>

WORLD HEADQUARTERS:
 233 Kansas St., El Segundo, California 90245
 Tel: (310) 252-7105