

**RADIATION HARDENED
 LOGIC LEVEL POWER MOSFET
 SURFACE MOUNT (SMD-0.2)**

**2N7609U8
 IRHLNM77110
 100V, N-CHANNEL
 R7 TECHNOLOGY**

Product Summary

Part Number	Radiation Level	R _{DS(on)}	I _D
IRHLNM77110	100K Rads (Si)	0.29Ω	6.5A
IRHLNM73110	300K Rads (Si)	0.29Ω	6.5A

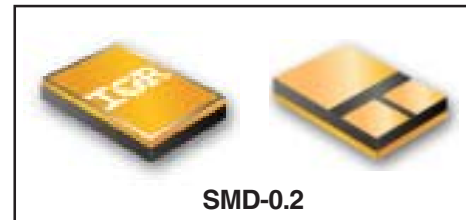

International Rectifier's R7™ Logic Level Power MOSFETs provide simple solution to interfacing CMOS and TTL control circuits to power devices in space and other radiation environments. The threshold voltage remains within acceptable operating limits over the full operating temperature and post radiation. This is achieved while maintaining single event gate rupture and single event burnout immunity.

The device is ideal when used to interface directly with most logic gates, linear IC's, micro-controllers, and other device types that operate from a 3.3-5V source. It may also be used to increase the output current of a PWM, voltage comparator or an operational amplifier where the logic level drive signal is available.

Features:

- 5V CMOS and TTL Compatible
- Fast Switching
- Single Event Effect (SEE) Hardened
- Low Total Gate Charge
- Simple Drive Requirements
- Ease of Paralleling
- Hermetically Sealed
- Ceramic Package
- Surface Mount
- Light Weight
- ESD Rating: Class 1A per MIL-STD-750, Method 1020

Absolute Maximum Ratings

Pre-Irradiation

	Parameter		Units
I _D @ V _{GS} = 4.5V, T _C = 25°C	Continuous Drain Current	6.5	A
I _D @ V _{GS} = 4.5V, T _C = 100°C	Continuous Drain Current	4.1	
I _{DM}	Pulsed Drain Current ①	26	
P _D @ T _C = 25°C	Max. Power Dissipation	23.2	W
	Linear Derating Factor	0.18	W/°C
V _{GS}	Gate-to-Source Voltage	±10	V
EAS	Single Pulse Avalanche Energy ②	21	mJ
I _{AR}	Avalanche Current ①	6.5	A
EAR	Repetitive Avalanche Energy ①	2.32	mJ
dv/dt	Peak Diode Recovery dv/dt ③	4.3	V/ns
T _J	Operating Junction	-55 to 150	°C
T _{STG}	Storage Temperature Range		
	Pckg. Mounting Surface Temp.	300 (for 5s)	
	Weight	0.25 (Typical)	

For footnotes refer to the last page

Electrical Characteristics @ T_j = 25°C (Unless Otherwise Specified)

	Parameter	Min	Typ	Max	Units	Test Conditions
BVDSS	Drain-to-Source Breakdown Voltage	100	—	—	V	V _{GS} = 0V, I _D = 250μA
ΔBVDSS/ΔT _J	Temperature Coefficient of Breakdown Voltage	—	0.105	—	V/°C	Reference to 25°C, I _D = 1.0mA
RDS(on)	Static Drain-to-Source On-State Resistance	—	—	0.29	Ω	V _{GS} = 4.5V, I _D = 4.1A ^④
VGS(th)	Gate Threshold Voltage	1.0	—	2.0	V	V _{DS} = V _{GS} , I _D = 250μA
ΔVGS(th)/ΔT _J	Gate Threshold Voltage Coefficient	—	-6.0	—	mV/°C	
g _{fs}	Forward Transconductance	3.5	—	—	S	V _{DS} = 15V, I _{DS} = 4.1A ^④
I _{DSS}	Zero Gate Voltage Drain Current	—	—	1.0	μA	V _{DS} = 80V, V _{GS} = 0V
		—	—	10		V _{DS} = 80V, V _{GS} = 0V, T _J = 125°C
I _{GSS}	Gate-to-Source Leakage Forward	—	—	100	nA	V _{GS} = 10V
I _{GSS}	Gate-to-Source Leakage Reverse	—	—	-100		V _{GS} = -10V
Q _g	Total Gate Charge	—	—	11	nC	V _{GS} = 4.5V, I _D = 6.5A V _{DS} = 50V
Q _{gs}	Gate-to-Source Charge	—	—	4.0		
Q _{gd}	Gate-to-Drain ('Miller') Charge	—	—	6.0		
t _{d(on)}	Turn-On Delay Time	—	—	18	ns	V _{DD} = 50V, I _D = 6.5A, V _{GS} = 5.0V, R _G = 7.5Ω
t _r	Rise Time	—	—	75		
t _{d(off)}	Turn-Off Delay Time	—	—	50		
t _f	Fall Time	—	—	12		
LS + LD	Total Inductance	—	6.8	—	nH	Measured from the center of drain pad to center of source pad
C _{iss}	Input Capacitance	—	572	—	pF	V _{GS} = 0V, V _{DS} = 25V f = 1.0MHz
C _{oss}	Output Capacitance	—	124	—		
C _{rss}	Reverse Transfer Capacitance	—	1.6	—		
R _g	Gate Resistance	—	10.5	—	Ω	f = 1.0MHz, open drain

Source-Drain Diode Ratings and Characteristics

	Parameter	Min	Typ	Max	Units	Test Conditions
I _S	Continuous Source Current (Body Diode)	—	—	6.5	A	T _J = 25°C, I _S = 6.5A, V _{GS} = 0V ^④
I _{SM}	Pulse Source Current (Body Diode) ^①	—	—	26		
V _{SD}	Diode Forward Voltage	—	—	1.4	V	T _J = 25°C, I _F = 6.5A, di/dt ≤ 100A/μs
t _{rr}	Reverse Recovery Time	—	—	215	ns	V _{DD} ≤ 25V ^④
Q _{RR}	Reverse Recovery Charge	—	—	1.05	μC	
t _{on}	Forward Turn-On Time	Intrinsic turn-on time is negligible. Turn-on speed is substantially controlled by LS + LD.				

Thermal Resistance

	Parameter	Min	Typ	Max	Units	Test Conditions
R _{thJC}	Junction-to-Case	—	—	5.4	°C/W	

Note: Corresponding Spice and Saber models are available on International Rectifier Web site.

For footnotes refer to the last page

Radiation Characteristics

IRHLNM77110, 2N7609U8

International Rectifier Radiation Hardened MOSFETs are tested to verify their radiation hardness capability. The hardness assurance program at International Rectifier is comprised of two radiation environments. Every manufacturing lot is tested for total ionizing dose (per notes 5 and 6) using the TO-3 package. Both pre- and post-irradiation performance are tested and specified using the same drive circuitry and test conditions in order to provide a direct comparison.

Table 1. Electrical Characteristics @ Tj = 25°C, Post Total Dose Irradiation ⑤⑥

	Parameter	Upto 300K Rads (Si) ¹		Units	Test Conditions
		Min	Max		
BV _{DSS}	Drain-to-Source Breakdown Voltage	100	—	V	V _{GS} = 0V, I _D = 250μA
V _{GS(th)}	Gate Threshold Voltage	1.0	2.0		V _{GS} = V _{DS} , I _D = 250μA
I _{GSS}	Gate-to-Source Leakage Forward	—	100	nA	V _{GS} = 10V
I _{GSS}	Gate-to-Source Leakage Reverse	—	-100		V _{GS} = -10V
I _{DSS}	Zero Gate Voltage Drain Current	—	1.0	μA	V _{DS} = 80V, V _{GS} = 0V
R _{DS(on)}	Static Drain-to-Source On-State Resistance (TO-3) ④	—	0.32	Ω	V _{GS} = 4.5V, I _D = 4.1A
R _{DS(on)}	Static Drain-to-Source On-state Resistance (SMD-0.2) ④	—	0.29	Ω	V _{GS} = 4.5V, I _D = 4.1A
V _{SD}	Diode Forward Voltage④	—	1.4	V	V _{GS} = 0V, I _D = 6.5A

1. Part numbers IRHLNM77110, IRHLNM73110

International Rectifier radiation hardened MOSFETs have been characterized in heavy ion environment for Single Event Effects (SEE). Single Event Effects characterization is illustrated in Fig. a and Table 2.

Table 2. Typical Single Event Effect Safe Operating Area

LET (MeV/(mg/cm ²))	Energy (MeV)	Range (μm)	V _{DS} (V)					
			@V _{GS} = 0V	@V _{GS} = -2V	@V _{GS} = -4V	@V _{GS} = -5V	@V _{GS} = -6V	@V _{GS} = -7V
38 ± 5%	300 ± 7.5%	38 ± 7.5%	100	100	100	100	100	100
62 ± 5%	355 ± 7.5%	33 ± 7.5%	100	100	100	100	100	-
85 ± 5%	380 ± 10%	29 ± 7.5%	100	100	100	100	-	-

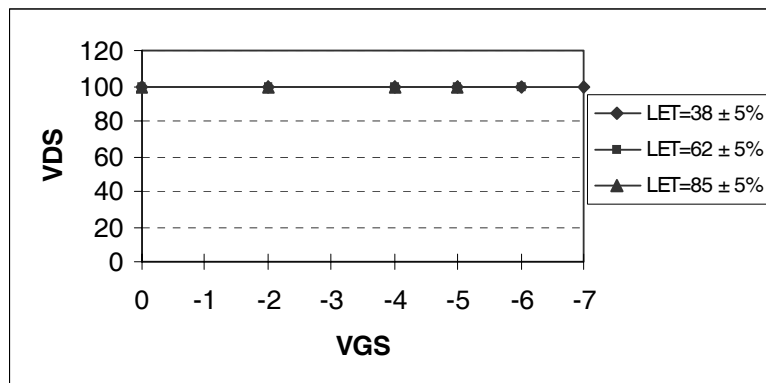

Fig a. Typical Single Event Effect, Safe Operating Area

For footnotes refer to the last page

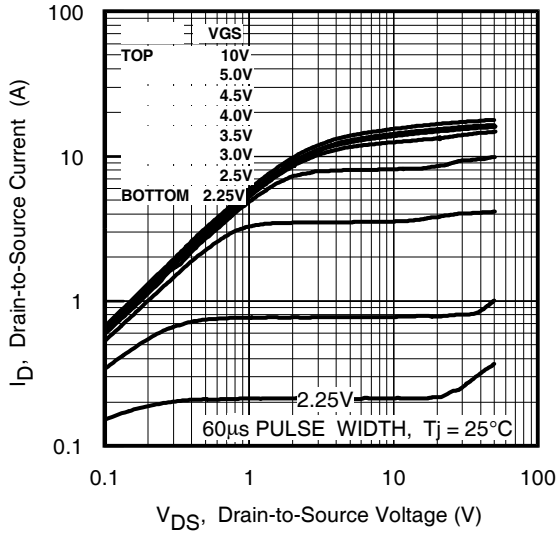

Fig 1. Typical Output Characteristics

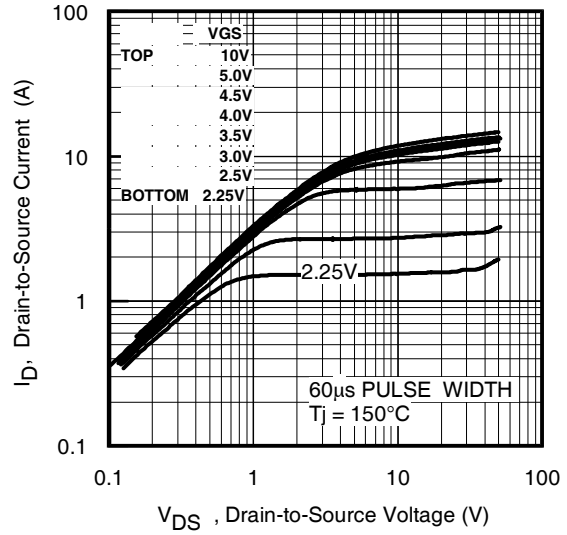

Fig 2. Typical Output Characteristics

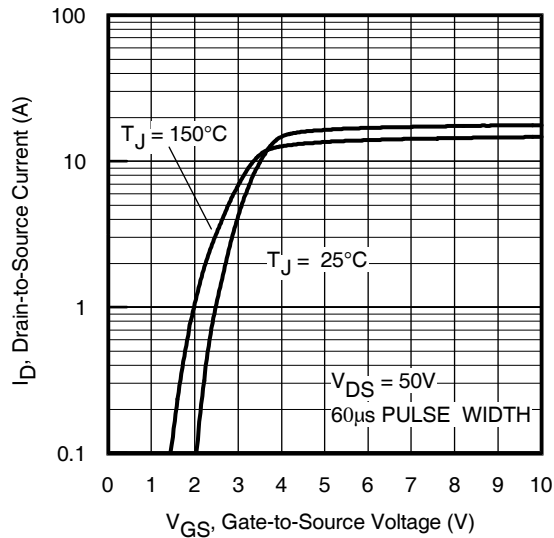

Fig 3. Typical Transfer Characteristics

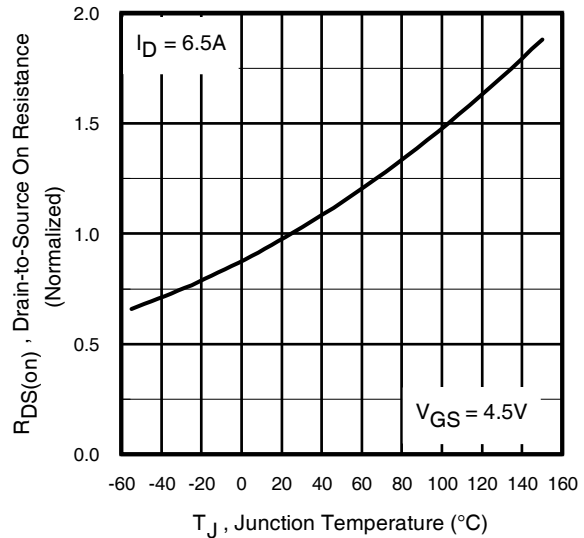

Fig 4. Normalized On-Resistance Vs. Temperature

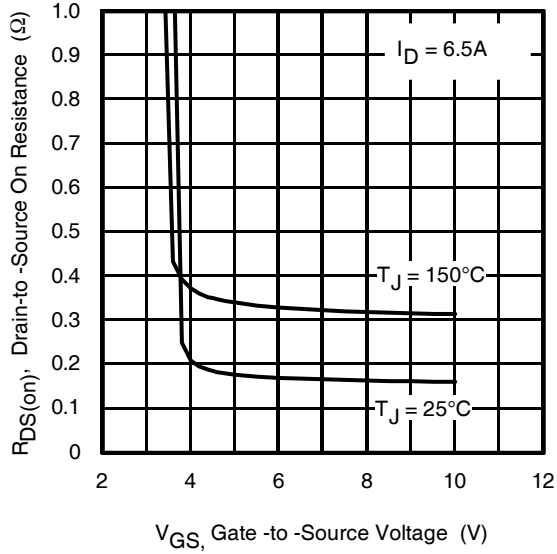

Fig 5. Typical On-Resistance Vs Gate Voltage

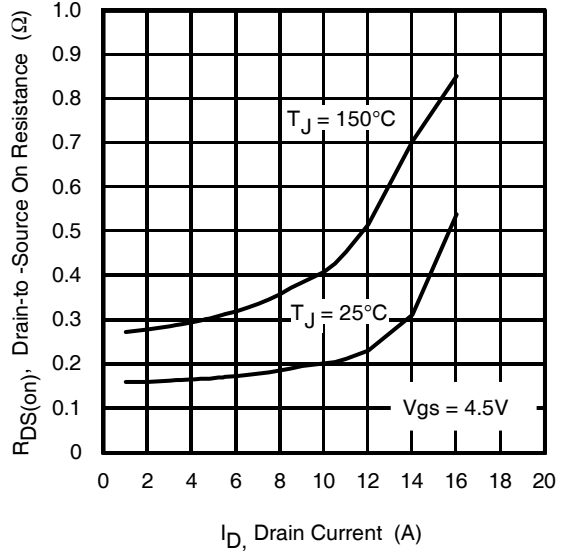

Fig 6. Typical On-Resistance Vs Drain Current

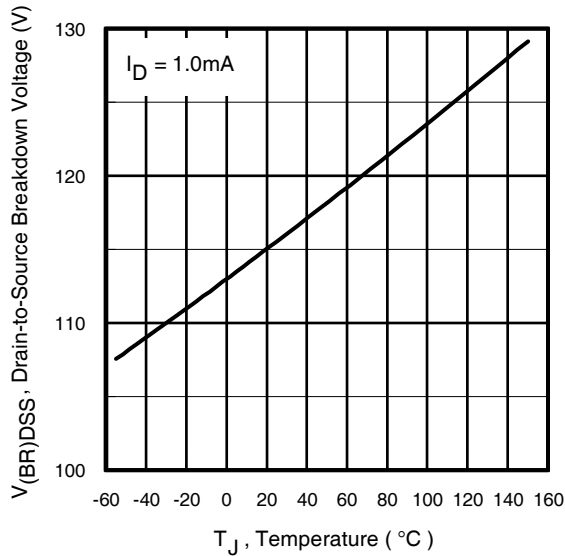

Fig 7. Typical Drain-to-Source Breakdown Voltage Vs Temperature

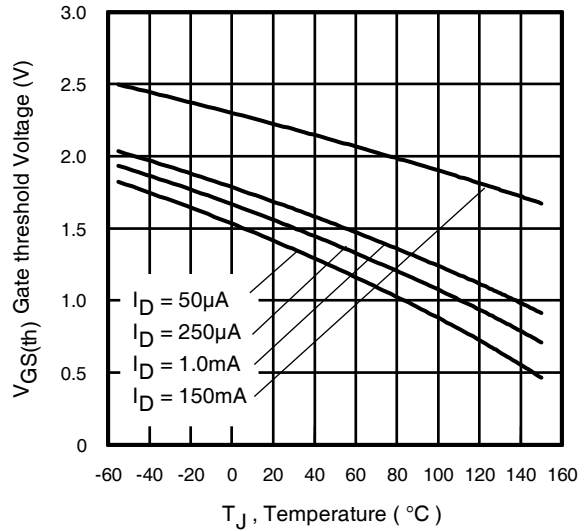

Fig 8. Typical Threshold Voltage Vs Temperature

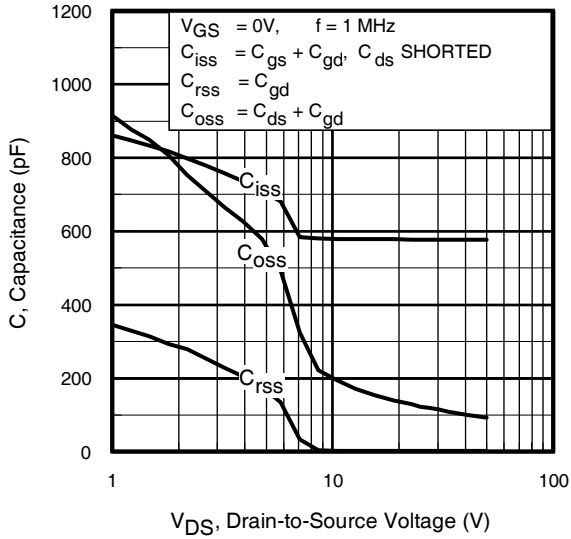

Fig 9. Typical Capacitance Vs. Drain-to-Source Voltage

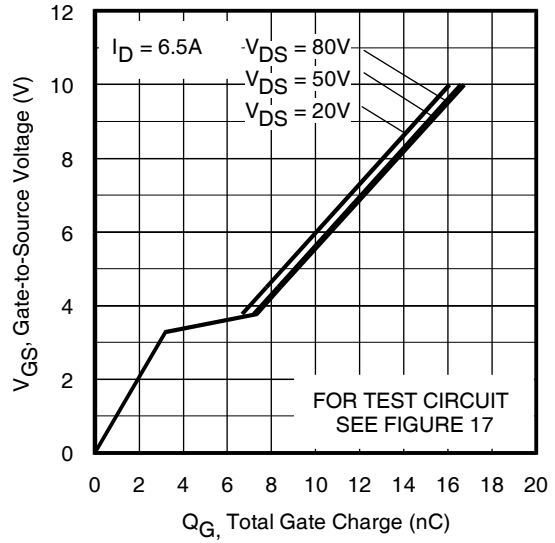

Fig 10. Typical Gate Charge Vs. Gate-to-Source Voltage

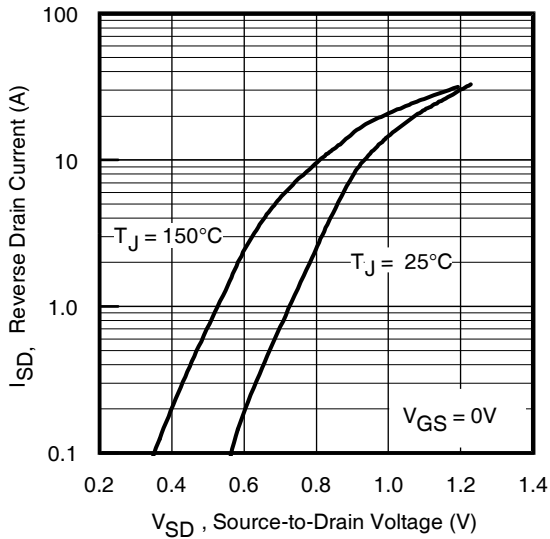

Fig 11. Typical Source-to-Drain Diode Forward Voltage

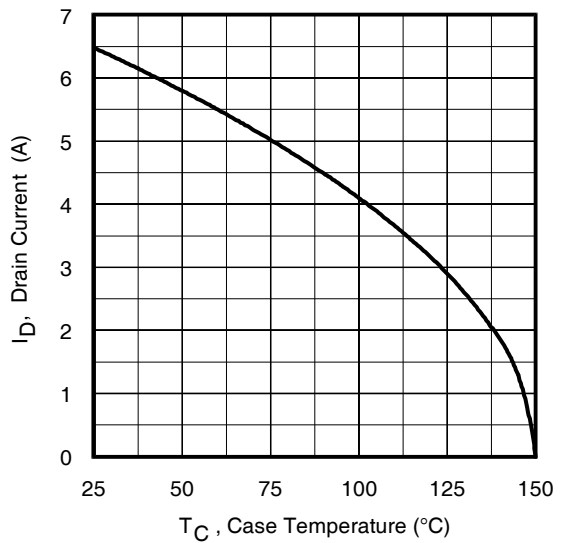

Fig 12. Maximum Drain Current Vs. Case Temperature

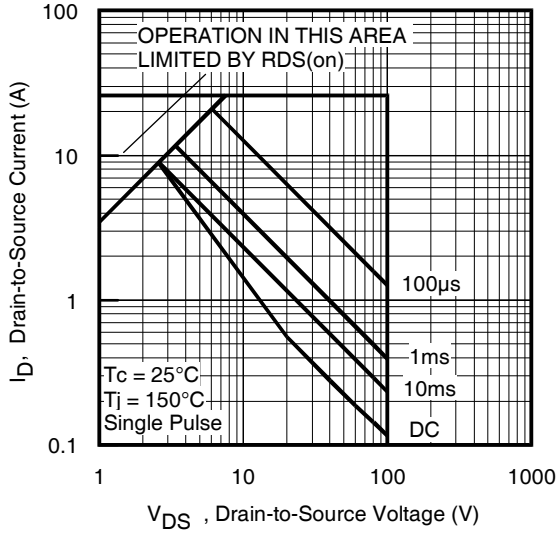

Fig 13. Maximum Safe Operating Area

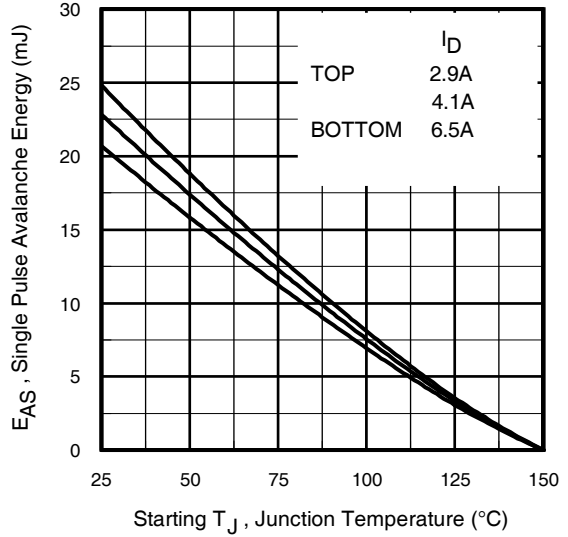

Fig 14. Maximum Avalanche Energy Vs. Drain Current

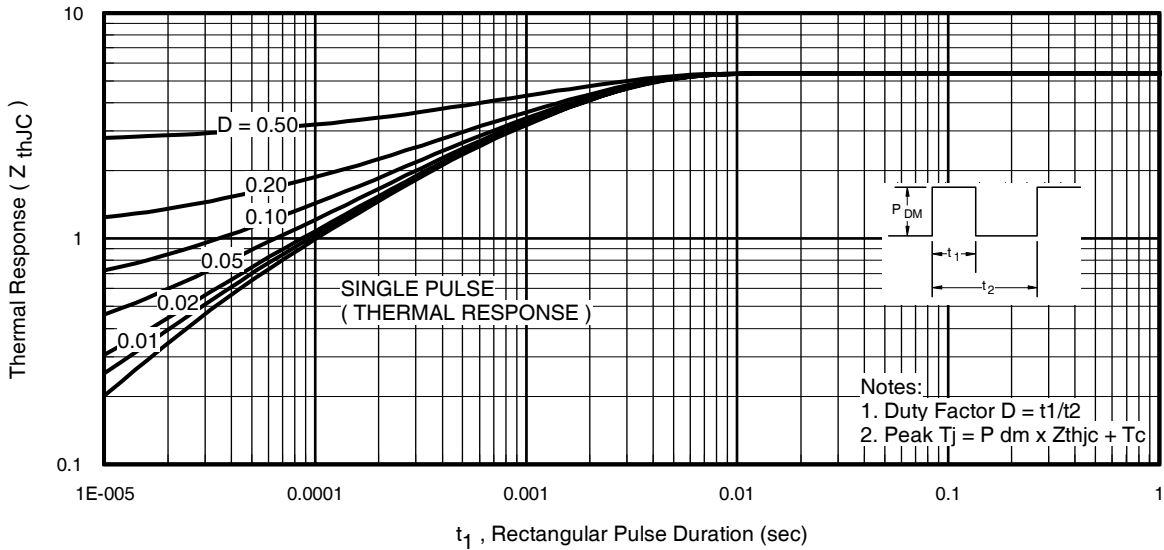

Fig 15. Maximum Effective Transient Thermal Impedance, Junction-to-Case

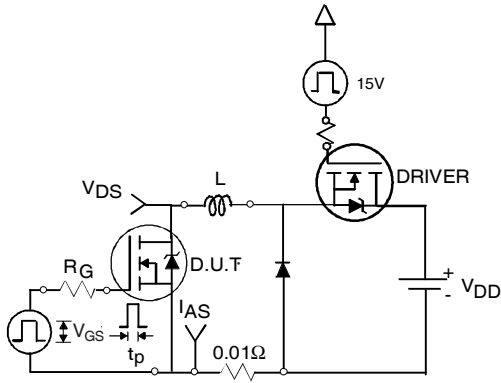

Fig 16a. Unclamped Inductive Test Circuit

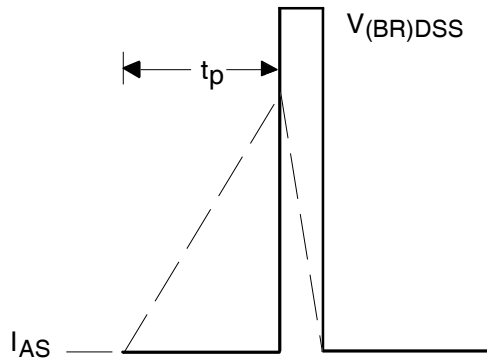

Fig 16b. Unclamped Inductive Waveforms

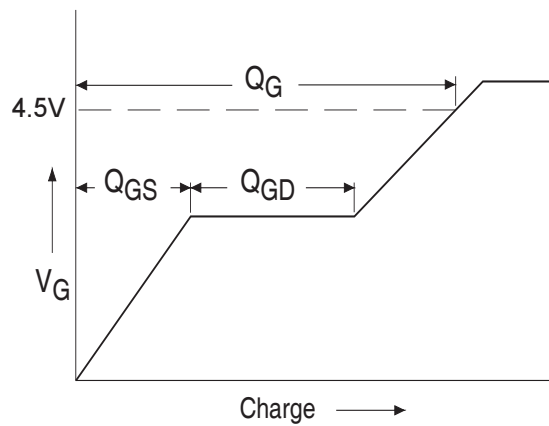

Fig 17a. Basic Gate Charge Waveform

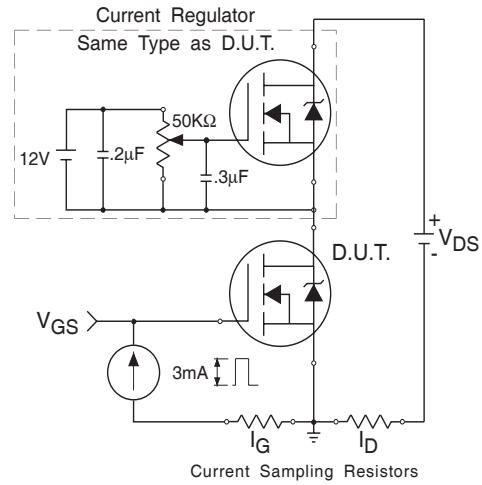

Fig 17b. Gate Charge Test Circuit

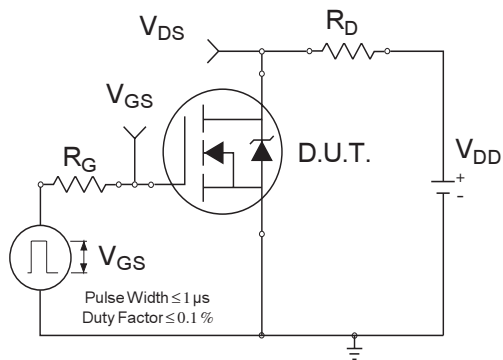

Fig 18a. Switching Time Test Circuit

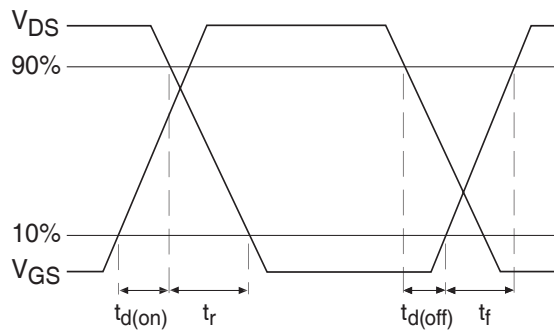

Fig 18b. Switching Time Waveforms

Pre-Irradiation

IRHLM77110, 2N7609U8

Footnotes:

- ① Repetitive Rating; Pulse width limited by maximum junction temperature.
- ② $V_{DD} = 25V$, starting $T_J = 25^\circ C$, $L = 0.98mH$
Peak $I_L = 6.5A$, $V_{GS} = 10V$
- ③ $I_{SD} \leq 6.5A$, $di/dt \leq 490A/\mu s$,
 $V_{DD} \leq 100V$, $T_J \leq 150^\circ C$
- ④ Pulse width $\leq 300 \mu s$; Duty Cycle $\leq 2\%$
- ⑤ **Total Dose Irradiation with V_{GS} Bias.**
10 volt V_{GS} applied and $V_{DS} = 0$ during irradiation per MIL-STD-750, method 1019, condition A.
- ⑥ **Total Dose Irradiation with V_{DS} Bias.**
80 volt V_{DS} applied and $V_{GS} = 0$ during irradiation per MIL-STD-750, method 1019, condition A.

Case Outline and Dimensions — SMD-0.2

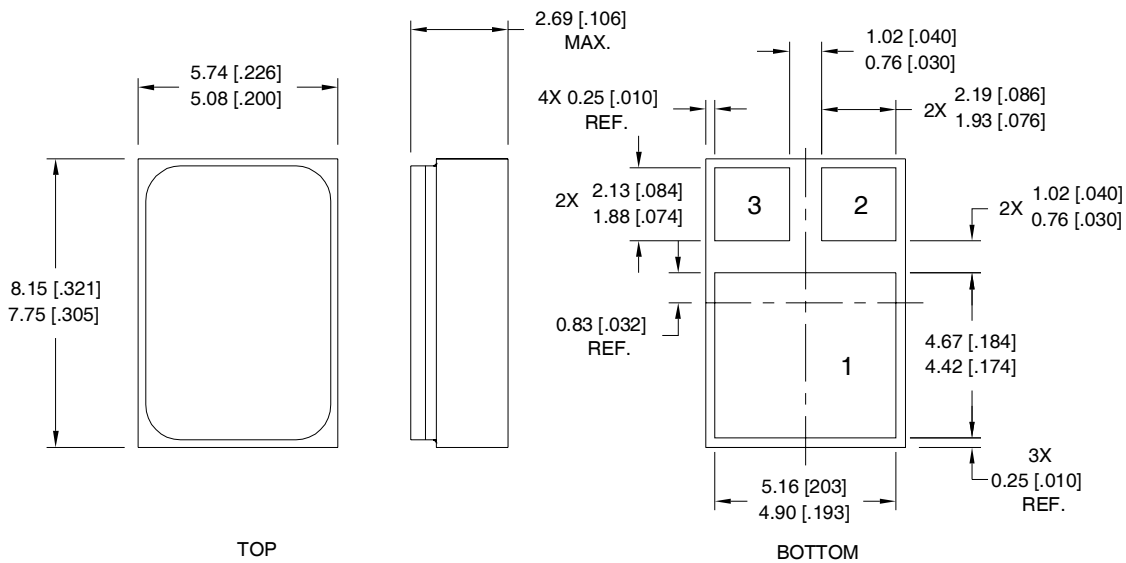

NOTES:

1. DIMENSIONING & TOLERANCING PER ASME Y14.5M-1994.
2. CONTROLLING DIMENSION: INCH.
3. DIMENSIONS ARE SHOWN IN MILLIMETERS [INCHES].

PAD ASSIGNMENT

- 1 = DRAIN
- 2 = GATE
- 3 = SOURCE

International
IOR Rectifier

IR WORLD HEADQUARTERS: 101 N, Sepulveda Blvd, El Segundo, California 90245, USA Tel: (310) 252-7105

IR LEOMINSTER : 205 Crawford St., Leominster, Massachusetts 01453, USA Tel: (978) 534-5776

TAC Fax: (310) 252-7903

Visit us at www.irf.com for sales contact information.

Data and specifications subject to change without notice. 12/2014