

Verpackt in Stangenprofil - Tube Packaging

Verpackungseinheit: 65 Stück - Packaging unit: 65 pcs

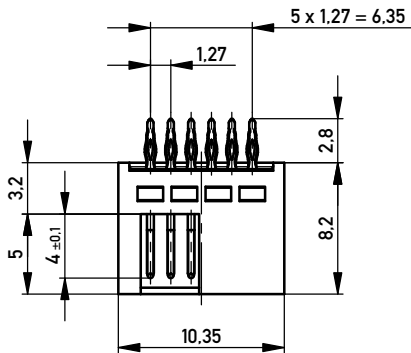

Lochbild für Leiterplatte
Board hole pattern

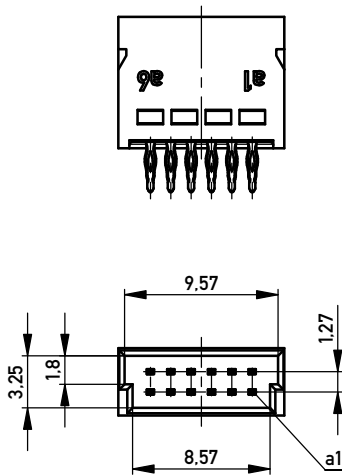
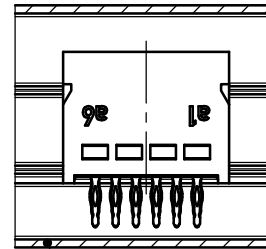
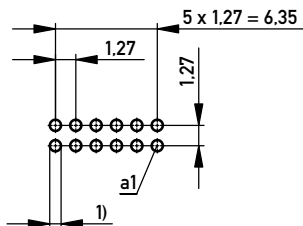

Stangenprofil - Tube Packaging
044915

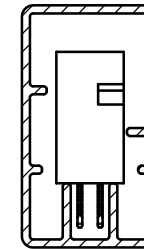



Anforderungsstufe 1
Performance Level 1

Kontaktbereich vergoldet
Mating Area gold plating

Anschlussbereich verzinkt 1-2 µm
Terminal Area 1-2 µm tin plating

1) Lochaufbau siehe ERNI-Spezifikation 164062 Nr. 1 hole design according to ERNI-specification 164062 No. 1

Information:	Tolerances	 All Dimensions in mm	Scale	3:1
	All rights reserved. Only for Information. To ensure that this is the latest version of this drawing, please contact one of the ERNI companies before using.		Designation Messertl. SMC-Q 12-EE-BA 3 Male SMC-Q 12-EE-type 3	
Subject to modification without prior notice. Drawing will not be updated.		 www.ERNI.com	064002	
d	06.07.2011		Class SMCQ	
Index	Date	I A3		

Copyright by ERNI GmbH
Proprietary notice pursuant to ISO 16016 to be observed.