

# IRF7756PbF

HEXFET® Power MOSFET

- Ultra Low On-Resistance
- Dual P-Channel MOSFET
- Very Small SOIC Package
- Low Profile (< 1.2mm)
- Available in Tape & Reel
- Lead-Free

$V_{DSS}$	$R_{DS(on) \max}$	$I_D$
<b>-12V</b>	0.040 @ $V_{GS} = -4.5V$	$\pm 4.3A$
	0.058 @ $V_{GS} = -2.5V$	$\pm 3.4A$
	0.087 @ $V_{GS} = -1.8V$	$\pm 2.2A$

## Description

HEXFET® Power MOSFETs from International Rectifier utilize advanced processing techniques to achieve extremely low on-resistance per silicon area. This benefit, combined with the ruggedized device design, that International Rectifier is well known for, provides the designer with an extremely efficient and reliable device for battery and load management.

The TSSOP-8 package has 45% less footprint area than the standard SO-8. This makes the TSSOP-8 an ideal device for applications where printed circuit board space is at a premium. The low profile (<1.1mm) allows it to fit easily into extremely thin environments such as portable electronics and PCMCIA cards.

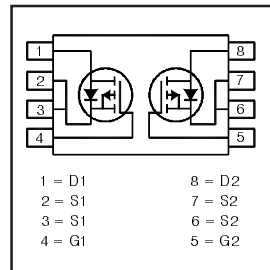

## Absolute Maximum Ratings

	Parameter	Max.	Units
$V_{DS}$	Drain-Source Voltage	-12	V
$I_D @ T_A = 25^\circ C$	Continuous Drain Current, $V_{GS} @ -4.5V$	-4.3	A
$I_D @ T_A = 70^\circ C$	Continuous Drain Current, $V_{GS} @ -4.5V$	-3.5	
$I_{DM}$	Pulsed Drain Current <sup>①</sup>	-17	
$P_D @ T_A = 25^\circ C$	Maximum Power Dissipation <sup>③</sup>	1.0	W
$P_D @ T_A = 70^\circ C$	Maximum Power Dissipation <sup>③</sup>	0.64	W
	Linear Derating Factor	8.0	mW/°C
$V_{GS}$	Gate-to-Source Voltage	$\pm 8.0$	V
$T_J, T_{STG}$	Junction and Storage Temperature Range	-55 to +150	°C

## Thermal Resistance

	Parameter	Max.	Units
$R_{\theta JA}$	Maximum Junction-to-Ambient <sup>③</sup>	125	°C/W

## Electrical Characteristics @ T<sub>J</sub> = 25°C (unless otherwise specified)

	Parameter	Min.	Typ.	Max.	Units	Conditions
V <sub>(BR)DSS</sub>	Drain-to-Source Breakdown Voltage	-12	—	—	V	V <sub>GS</sub> = 0V, I <sub>D</sub> = -250μA
ΔV <sub>(BR)DSS</sub> /ΔT <sub>J</sub>	Breakdown Voltage Temp. Coefficient	—	-0.006	—	V/°C	Reference to 25°C, I <sub>D</sub> = -1mA
R <sub>DS(on)</sub>	Static Drain-to-Source On-Resistance	—	—	0.040	Ω	V <sub>GS</sub> = -4.5V, I <sub>D</sub> = -4.3A ②
		—	—	0.058		V <sub>GS</sub> = -2.5V, I <sub>D</sub> = -3.4A ②
		—	—	0.087		V <sub>GS</sub> = -1.8V, I <sub>D</sub> = -2.2A ②
V <sub>GS(th)</sub>	Gate Threshold Voltage	-0.4	—	-0.9	V	V <sub>DS</sub> = V <sub>GS</sub> , I <sub>D</sub> = -250μA
g <sub>fs</sub>	Forward Transconductance	13	—	—	S	V <sub>DS</sub> = -10V, I <sub>D</sub> = -4.3A
I <sub>DSS</sub>	Drain-to-Source Leakage Current	—	—	-1.0	μA	V <sub>DS</sub> = -9.6V, V <sub>GS</sub> = 0V
		—	—	-25		V <sub>DS</sub> = -9.6V, V <sub>GS</sub> = 0V, T <sub>J</sub> = 70°C
I <sub>GSS</sub>	Gate-to-Source Forward Leakage	—	—	-100	nA	V <sub>GS</sub> = -8.0V
	Gate-to-Source Reverse Leakage	—	—	100		V <sub>GS</sub> = 8.0V
Q <sub>g</sub>	Total Gate Charge	—	12	18	nC	I <sub>D</sub> = -4.3A
Q <sub>gs</sub>	Gate-to-Source Charge	—	1.8	2.7		V <sub>DS</sub> = -6.0V
Q <sub>gd</sub>	Gate-to-Drain ("Miller") Charge	—	2.9	4.4		V <sub>GS</sub> = -4.5V
t <sub>d(on)</sub>	Turn-On Delay Time	—	12	—	ns	V <sub>DD</sub> = -6.0V, I <sub>D</sub> = -1.0A R <sub>G</sub> = 6.0Ω V <sub>GS</sub> = -4.5V ②
t <sub>r</sub>	Rise Time	—	18	—		
t <sub>d(off)</sub>	Turn-Off Delay Time	—	160	—		
t <sub>f</sub>	Fall Time	—	170	—		
C <sub>iss</sub>	Input Capacitance	—	1400	—	pF	V <sub>GS</sub> = 0V
C <sub>oss</sub>	Output Capacitance	—	310	—		V <sub>DS</sub> = -10V
C <sub>riss</sub>	Reverse Transfer Capacitance	—	240	—		f = 1.0kHz

## Source-Drain Ratings and Characteristics

	Parameter	Min.	Typ.	Max.	Units	Conditions
I <sub>S</sub>	Continuous Source Current (Body Diode)	—	—	-1.0	A	MOSFET symbol showing the integral reverse p-n junction diode.
I <sub>SM</sub>	Pulsed Source Current (Body Diode) ①	—	—	-17		
V <sub>SD</sub>	Diode Forward Voltage	—	—	-1.2	V	T <sub>J</sub> = 25°C, I <sub>S</sub> = -1.0A, V <sub>GS</sub> = 0V ②
t <sub>rr</sub>	Reverse Recovery Time	—	35	53	ns	T <sub>J</sub> = 25°C, I <sub>F</sub> = -1.0A
Q <sub>rr</sub>	Reverse Recovery Charge	—	20	30	nC	di/dt = -100A/μs ②

### Notes:

- ① Repetitive rating; pulse width limited by max. junction temperature.  
② Pulse width ≤ 400μs; duty cycle ≤ 2%.

- ③ Surface mounted on FR-4 board, t ≤ 10sec.

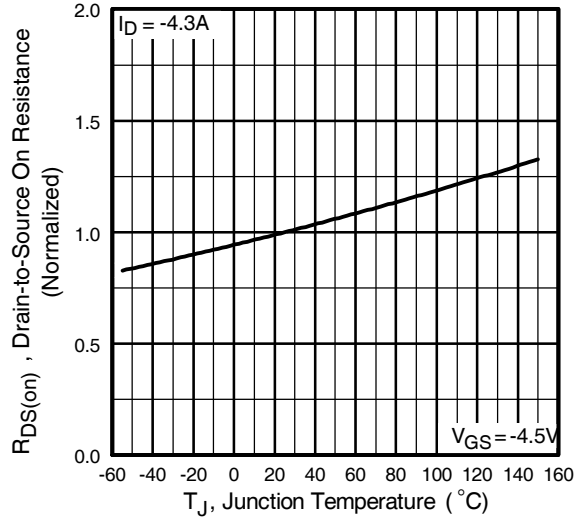
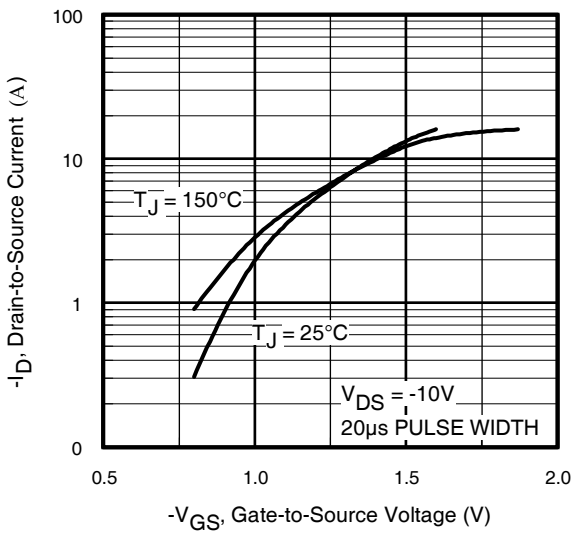
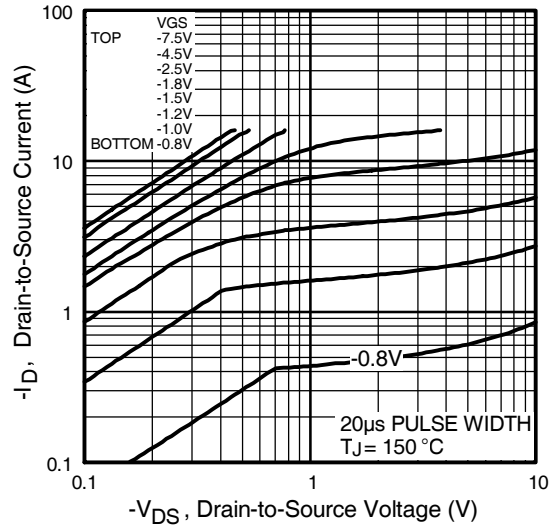
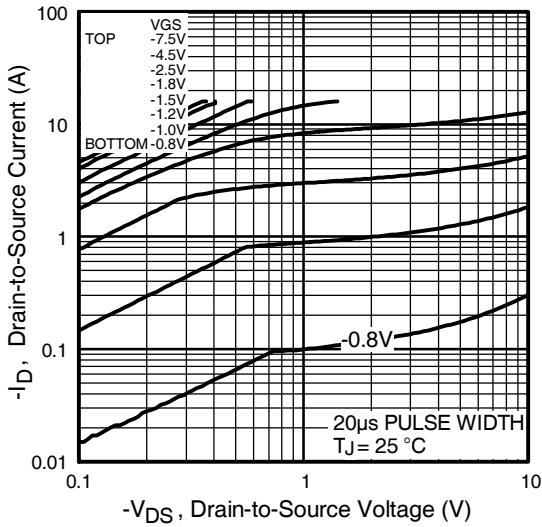

# IRF7756PbF

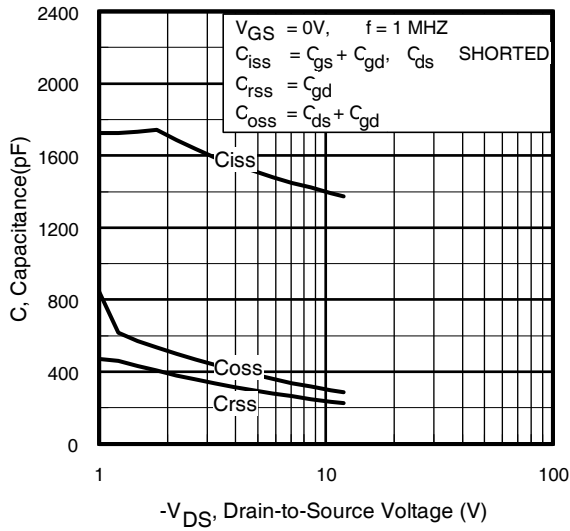

**Fig 5.** Typical Capacitance Vs. Drain-to-Source Voltage

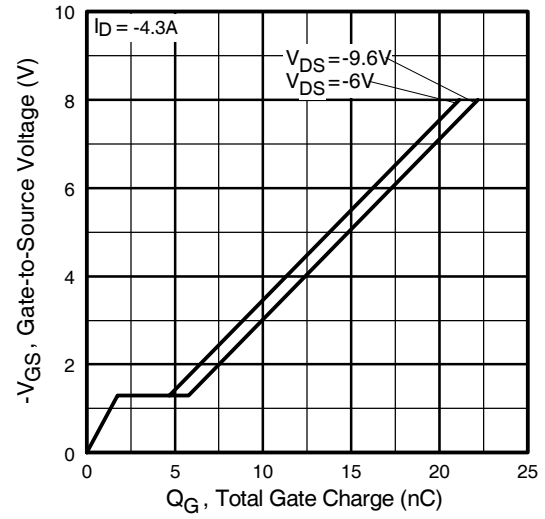

**Fig 6.** Typical Gate Charge Vs. Gate-to-Source Voltage

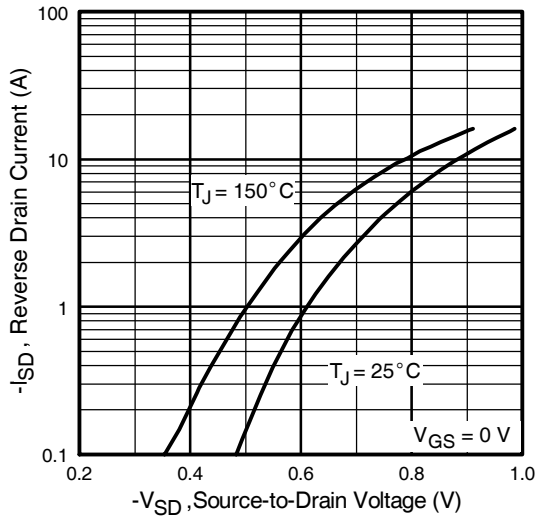

**Fig 7.** Typical Source-Drain Diode Forward Voltage

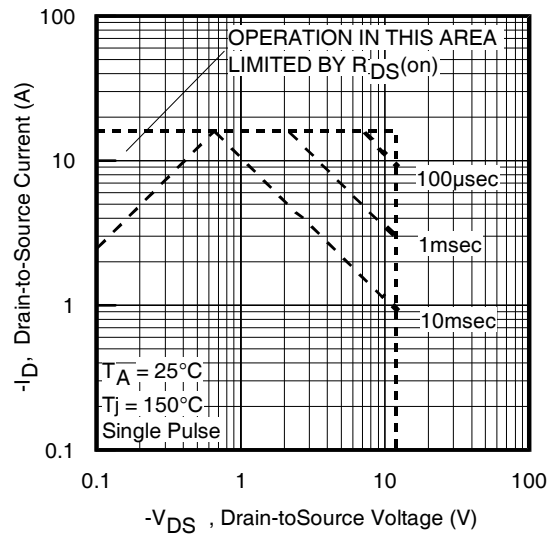

**Fig 8.** Maximum Safe Operating Area

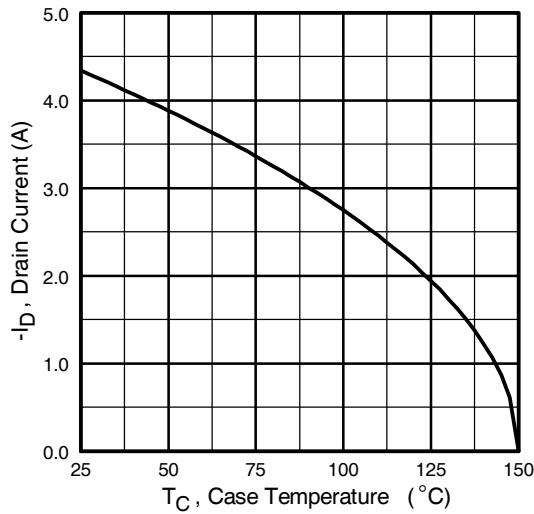

**Fig 9.** Maximum Drain Current Vs. Case Temperature

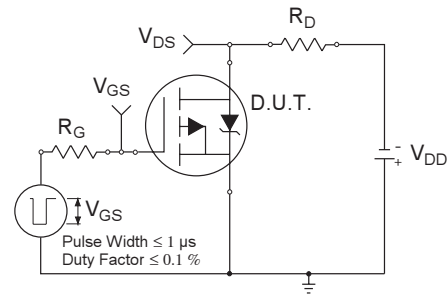

**Fig 10a.** Switching Time Test Circuit

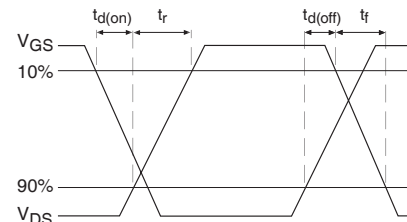

**Fig 10b.** Switching Time Waveforms

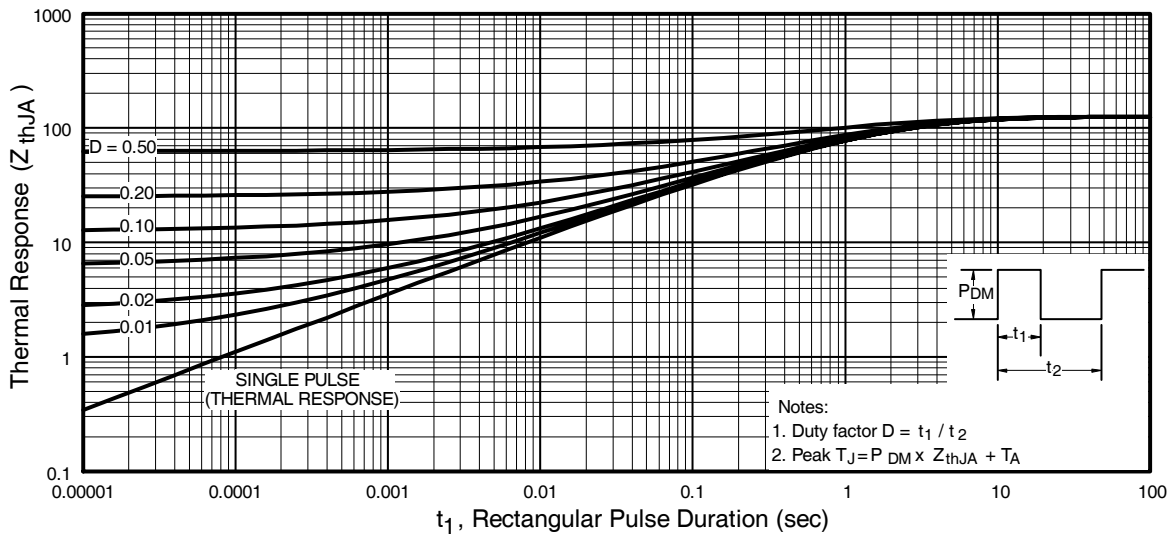

**Fig 10.** Typical Effective Transient Thermal Impedance, Junction-to-Ambient

# IRF7756PbF

International  
**IR** Rectifier

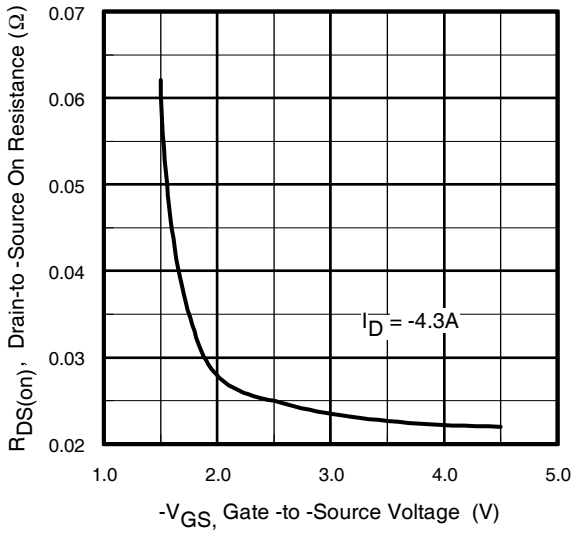

**Fig 11.** Typical On-Resistance Vs. Gate Voltage

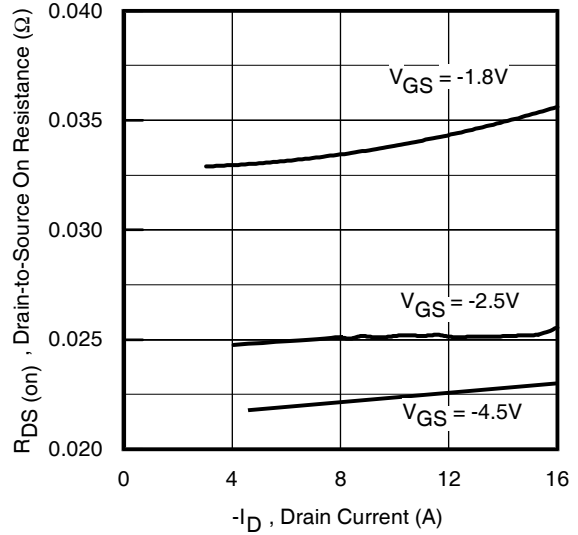

**Fig 12.** Typical On-Resistance Vs. Drain Current

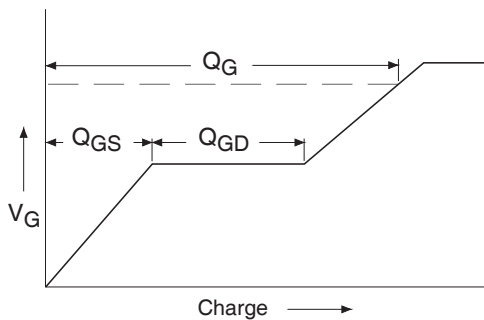

**Fig 13a.** Basic Gate Charge Waveform

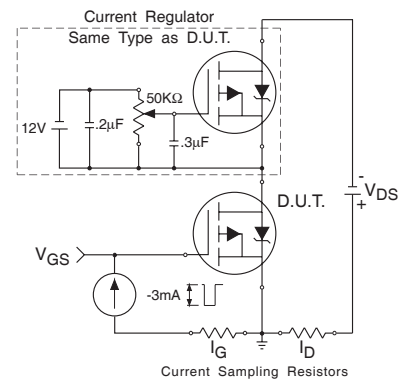

**Fig 13b.** Gate Charge Test Circuit

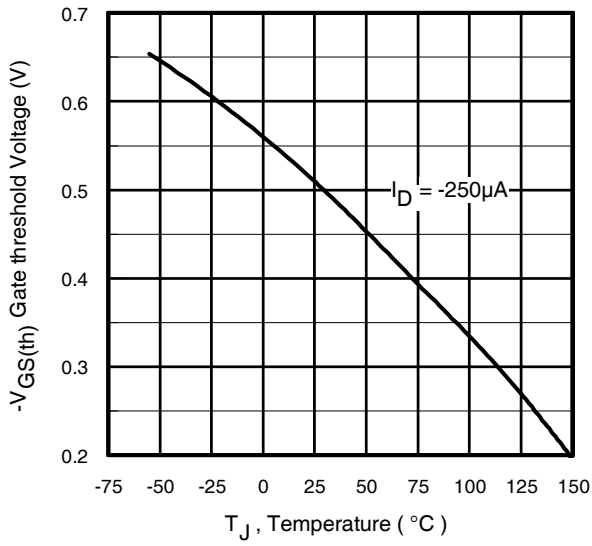

**Fig 14.** Threshold Voltage Vs. Temperature

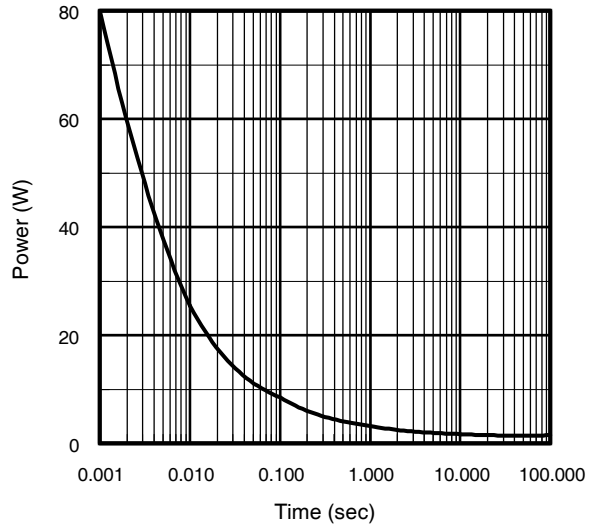

**Fig 15.** Typical Power Vs. Time

# IRF7756PbF

International  
**IR** Rectifier

## TSSOP8 Package Outline

Dimensions are shown in millimeters (inches)

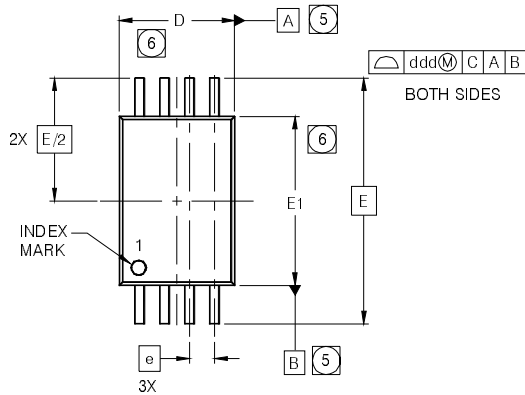

SYMBOL	MO-153AA DIMENSIONS					
	MILLIMETERS			INCHES		
	MIN	NOM	MAX	MIN	NOM	MAX
A	---	---	1.20	---	---	.0472
A1	0.05	---	0.15	.0020	---	.0059
A2	0.80	1.00	1.05	.032	.039	.041
b	0.19	---	0.30	.0075	---	.0118
c	0.09	---	0.20	.0036	---	.0078
D	2.90	3.00	3.10	.115	.118	.122
E	6.40 BSC			.251 BSC		
E1	4.30	4.40	4.50	.170	.173	.177
e	0.65 BSC			.0256		
L	0.45	0.60	0.75	.0178	.0236	.0290
L1	0.25 BSC			.010 BSC		
θ	0°	---	8°	0°	---	8°
aaa	0.10		.0039			
bbb	0.10		.0039			
ccc	0.05		.0019			
ddd	0.20		.0078			

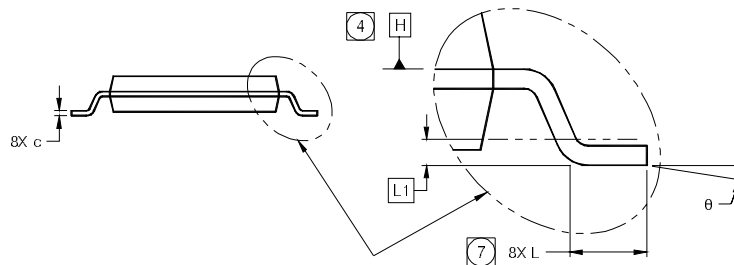
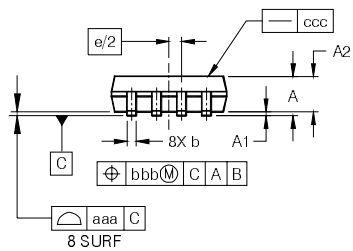

### LEAD ASSIGNMENTS



### NOTES

1. DIMENSIONING AND TOLERANCING PER ASME Y14.5M-1994.
2. DIMENSIONS ARE SHOWN IN MILLIMETERS AND INCHES.
3. CONTROLLING DIMENSION: MILLIMETER.
4. DATUM PLANE H IS LOCATED AS SHOWN.
5. DATUM A AND B TO BE DETERMINED AT DATUM PLANE H.
6. DIMENSIONS D AND E1 ARE MEASURED AT DATUM PLANE H.
7. DIMENSION L IS THE LEAD LENGTH FOR SOLDERING TO A SUBSTRATE.
8. OUTLINE CONFORMS TO JEDEC OUTLINE MO-153AA.

Note: For the most current drawing please refer to IR website at <http://www.irf.com/package/>



## TSSOP8 Part Marking Information

EXAMPLE: THIS IS AN IRF8852PBF

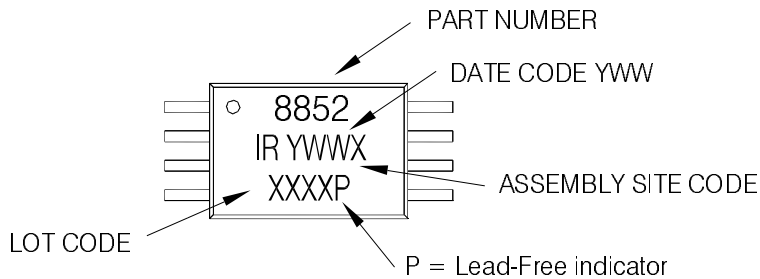

## TSSOP-8 Tape and Reel Information

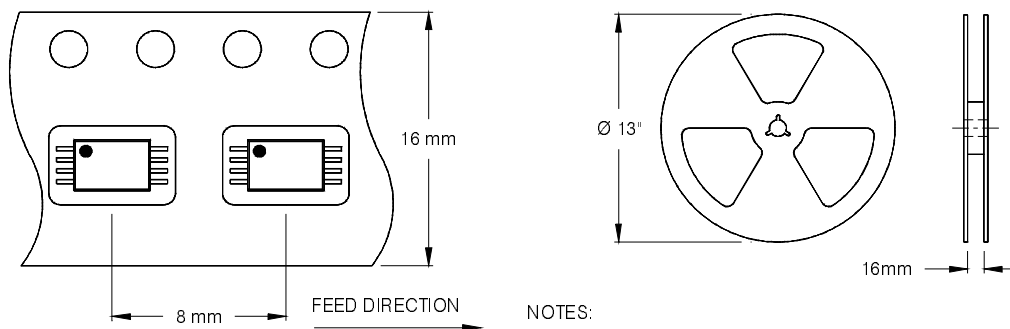

NOTES:

1. TAPE & REEL OUTLINE CONFORMS TO EIA-481 & EIA-541.

**Note:** For the most current drawing please refer to IR website at <http://www.irf.com/package/>

Data and specifications subject to change without notice.  
 This product has been designed and qualified for the Consumer market.  
 Qualification Standards can be found on IR's Web site.