

μPG2413T6Z

GaAs Integrated Circuit
 SP3T Switch for Bluetooth™ and 802.11b/g

R09DS0001EJ0100
 Rev.1.00
 May 20, 2010

DESCRIPTION

The μPG2413T6Z is a GaAs MMIC SP3T switch which was developed for Bluetooth, wireless LAN. This device can operate at frequencies from 0.5 to 3.0 GHz, with low insertion loss. This device is housed in a 8-pin plastic TSON (Thin Small Out-line Flat Non-leaded) package and is suitable for high-density surface mounting.

FEATURES

- Switch Control voltage : $V_{\text{cont(H)}} = 3.0 \text{ V TYP.}$, $V_{\text{cont(L)}} = 0 \text{ V TYP.}$
- Low insertion loss : $L_{\text{ins}} = 0.35 \text{ dB TYP. @ } f = 1.0 \text{ GHz}$
 : $L_{\text{ins}} = 0.45 \text{ dB TYP. @ } f = 2.0 \text{ GHz}$
 : $L_{\text{ins}} = 0.50 \text{ dB TYP. @ } f = 2.5 \text{ GHz}$
- High isolation : $ISL = 26 \text{ dB TYP. @ } f = 1.0 \text{ GHz}$
 : $ISL = 20 \text{ dB TYP. @ } f = 2.0 \text{ GHz}$
 : $ISL = 18 \text{ dB TYP. @ } f = 2.5 \text{ GHz}$
- Handling power : $P_{\text{in(0.1 dB)}} = +28.0 \text{ dBm TYP. @ } f = 2.5 \text{ GHz}$, $V_{\text{cont(H)}} = 3.0 \text{ V}$, $V_{\text{cont(L)}} = 0 \text{ V}$
- High-density surface mounting : 8-pin plastic TSON package (1.5 × 1.5 × 0.37 mm)

APPLICATIONS

- Bluetooth and IEEE802.11b/g etc.

ORDERING INFORMATION

Part Number	Order Number	Package	Marking	Supplying Form
μPG2413T6Z-E2	μPG2413T6Z-E2-A	8-pin plastic TSON (Pb-Free)	G6F	<ul style="list-style-type: none"> • Embossed tape 8 mm wide • Pin 1, 8 face the perforation side of the tape • Qty 3 kpcs/reel

Remark To order evaluation samples, please contact your nearby sales office.

Part number for sample order: μPG2413T6Z

CAUTION

Although this device is designed to be as robust as possible, ESD (Electrostatic Discharge) can damage this device. This device must be protected at all times from ESD. Static charges may easily produce potentials of several kilovolts on the human body or equipment, which can discharge without detection. Industry-standard ESD precautions must be employed at all times.

PIN CONNECTIONS AND INTERNAL BLOCK DIAGRAM

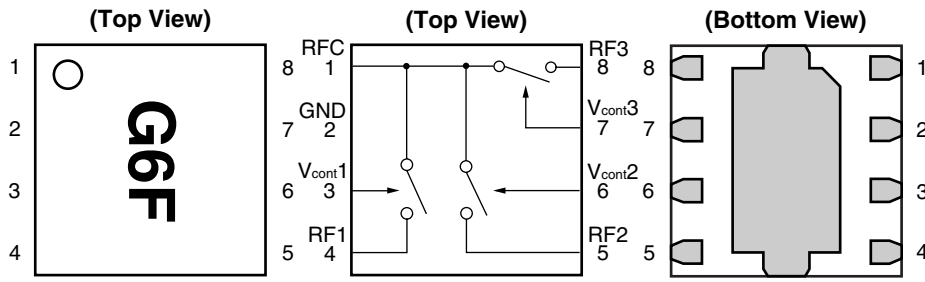

Pin No.	Pin Name
1	RFC
2	GND
3	V _{cont1}
4	RF1
5	RF2
6	V _{cont2}
7	V _{cont3}
8	RF3

Remark Exposed pad : GND

TRUTH TABLE

V _{cont1}	V _{cont2}	V _{cont3}	RFC–RF1	RFC–RF2	RFC–RF3
High	Low	Low	ON	OFF	OFF
Low	High	Low	OFF	ON	OFF
Low	Low	High	OFF	OFF	ON

ABSOLUTE MAXIMUM RATINGS (T_A = +25°C, unless otherwise specified)

Parameter	Symbol	Ratings	Unit
Switch Control Voltage	V _{cont}	+6.0 ^{Note}	V
Input Power (V _{cont (H)} = 1.8 V)	P _{in}	+26	dBm
Input Power (V _{cont (H)} = 2.3 V)	P _{in}	+28	dBm
Input Power (V _{cont (H)} = 3.0 V)	P _{in}	+32	dBm
Input Power (V _{cont (H)} = 3.6 V)	P _{in}	+34	dBm
Operating Ambient Temperature	T _A	–45 to +85	°C
Storage Temperature	T _{stg}	–55 to +150	°C

Note: |V_{cont (H)} – V_{cont (L)}| ≤ 6.0 V

RECOMMENDED OPERATING RANGE (T_A = +25°C)

Parameter	Symbol	MIN.	TYP.	MAX.	Unit
Operating Frequency	f	0.5	–	3.0	GHz
Switch Control Voltage (H)	V _{cont (H)}	1.8	3.0	3.6	V
Switch Control Voltage (L)	V _{cont (L)}	–0.2	0	0.2	V
Control Voltage Difference (H)	ΔV _{cont (H)} ^{Note1}	–0.1	0	0.1	V
Control Voltage Difference (L)	ΔV _{cont (L)} ^{Note2}	–0.1	0	0.1	V

- Notes: 1. ΔV_{cont (H)} is a difference between the maximum and the minimum control voltages among V_{cont1 (H)}, V_{cont2 (H)} and V_{cont3 (H)}.
 2. ΔV_{cont (L)} is a difference between the maximum and the minimum control voltages among V_{cont1 (L)}, V_{cont2 (L)} and V_{cont3 (L)}.

ELECTRICAL CHARACTERISTICS 1

($T_A = +25^\circ\text{C}$, $V_{\text{cont (H)}} = 3.0\text{ V}$, $V_{\text{cont (L)}} = 0\text{ V}$, $Z_O = 50\ \Omega$, DC blocking capacitors = 56 pF, unless otherwise specified)

Parameter	Symbol	Pass	Test Conditions	MIN.	TYP.	MAX.	Unit
Insertion Loss	L_{ins}	RFC to RF1, 2, 3	f = 0.5 to 1.0 GHz	–	0.35	0.60	dB
			f = 1.0 to 2.0 GHz	–	0.45	0.70	dB
			f = 2.0 to 2.5 GHz	–	0.50	0.75	dB
			f = 2.5 to 3.0 GHz	–	0.60	–	dB
Isolation	ISL	RFC to RF1, 2, 3 (OFF)	f = 0.5 to 1.0 GHz	23	26	–	dB
			f = 1.0 to 2.0 GHz	17	20	–	dB
			f = 2.0 to 2.5 GHz	15	18	–	dB
			f = 2.5 to 3.0 GHz	–	16	–	dB
Return Loss (RFC)	RL_C		f = 0.5 to 3.0 GHz	15	20	–	dB
Return Loss (RF1, 2, 3)	$RL_{1, 2, 3}$		f = 0.5 to 3.0 GHz	15	20	–	dB
0.1 dB Loss Compression Input Power ^{Note 1}	$P_{\text{in (0.1 dB)}}$	RFC to RF1, 2, 3	f = 2.5 GHz	+25.0	+28.0	–	dBm
1 dB Loss Compression Input Power ^{Note 2}	$P_{\text{in (1 dB)}}$	RFC to RF1, 2, 3	f = 2.5 GHz, $V_{\text{cont (H)}} = 2.3\text{ V}$	–	+27.0	–	dBm
			f = 2.5 GHz, $V_{\text{cont (H)}} = 3.0\text{ V}$	–	+31.0	–	dBm
			f = 2.5 GHz, $V_{\text{cont (H)}} = 3.6\text{ V}$	–	+33.0	–	dBm
2nd Harmonics	2f0		f = 2.5 GHz, $P_{\text{in}} = 23\text{ dBm}$	–	75	–	dBc
3rd Harmonics	3f0		f = 2.5 GHz, $P_{\text{in}} = 23\text{ dBm}$	–	75	–	dBc
Switch Control Current	I_{cont}		No RF input	–	0.1	5.0	μA
Switch Control Speed	t_{sw}		50% CTL to 90/10% RF	–	50	–	ns

- Notes: 1. $P_{\text{in (0.1 dB)}}$ is the measured input power level when the insertion loss increases 0.1 dB more than that of the linear range.
 2. $P_{\text{in (1 dB)}}$ is the measured input power level when the insertion loss increases 1 dB more than that of the linear range.

CAUTION

It is necessary to use DC blocking capacitors with this device.

ELECTRICAL CHARACTERISTICS 2

($T_A = +25^\circ\text{C}$, $V_{\text{cont (H)}} = 1.8\text{ V}$, $V_{\text{cont (L)}} = 0\text{ V}$, $Z_O = 50\ \Omega$, DC blocking capacitors = 56 pF, unless otherwise specified)

Parameter	Symbol	Pass	Test Conditions	MIN.	TYP.	MAX.	Unit
Insertion Loss	L_{ins}	RFC to RF1, 2, 3	f = 0.5 to 1.0 GHz	–	0.35	0.65	dB
			f = 1.0 to 2.0 GHz	–	0.45	0.75	dB
			f = 2.0 to 2.5 GHz	–	0.50	0.80	dB
			f = 2.5 to 3.0 GHz	–	0.65	–	dB
Isolation	ISL	RFC to RF1, 2, 3 (OFF)	f = 0.5 to 1.0 GHz	22.5	25.5	–	dB
			f = 1.0 to 2.0 GHz	16.5	19.5	–	dB
			f = 2.0 to 2.5 GHz	14.5	17.5	–	dB
			f = 2.5 to 3.0 GHz	–	15.5	–	dB
Return Loss (RFC)	RL_C		f = 0.5 to 3.0 GHz	15	20	–	dB
Return Loss (RF1, 2, 3)	$RL_{1, 2, 3}$		f = 0.5 to 3.0 GHz	15	20	–	dB
0.1 dB Loss Compression Input Power <small>Note 1</small>	$P_{\text{in (0.1 dB)}}$	RFC to RF1, 2, 3	f = 2.5 GHz	+19.0	+22.0	–	dBm
1 dB Loss Compression Input Power <small>Note 2</small>	$P_{\text{in (1 dB)}}$	RFC to RF1, 2, 3	f = 2.5 GHz	+21.0	+25.0	–	dBm
2nd Harmonics	2f0		f = 2.5 GHz, $P_{\text{in}} = 17\text{ dBm}$	–	75	–	dBc
3rd Harmonics	3f0		f = 2.5 GHz, $P_{\text{in}} = 17\text{ dBm}$	–	75	–	dBc
Switch Control Current	I_{cont}		No RF input	–	0.1	5.0	μA
Switch Control Speed	t_{sw}		50% CTL to 90/10% RF	–	50	–	ns

Notes: 1. $P_{\text{in (0.1 dB)}}$ is the measured input power level when the insertion loss increases 0.1 dB more than that of the linear range.

2. $P_{\text{in (1 dB)}}$ is the measured input power level when the insertion loss increases 1 dB more than that of the linear range.

CAUTION

It is necessary to use DC blocking capacitors with this device.

EVALUATION CIRCUIT

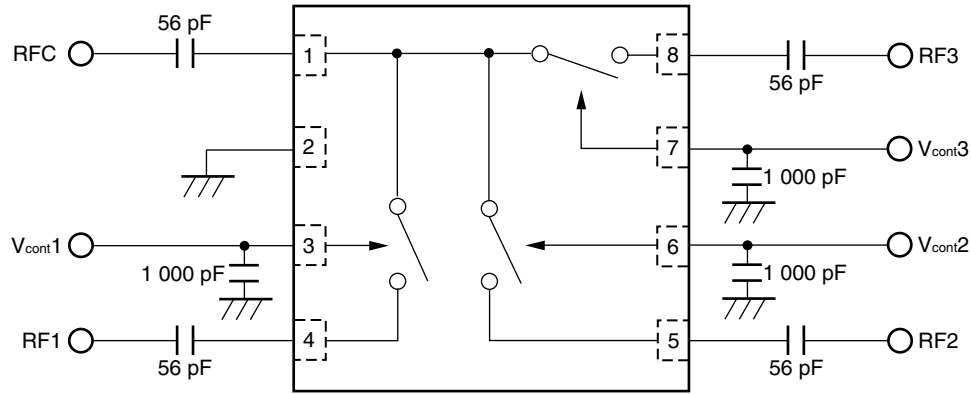

The application circuits and their parameters are for reference only and are not intended for use in actual design-ins.

APPLICATION INFORMATION

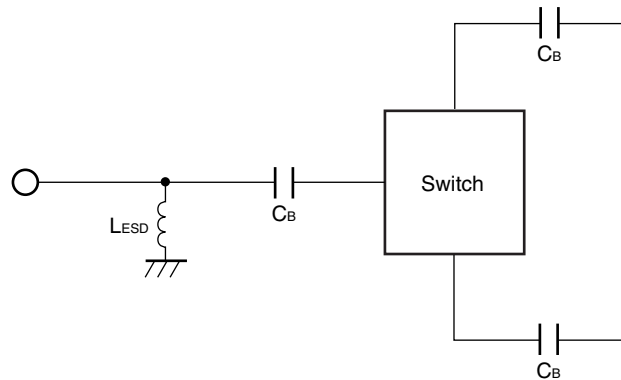

- C_B are DC blocking capacitors external to the device.
A value of 56 pF is sufficient for operation from 500 MHz to 2.5 GHz bands.
The value may be tailored to provide specific electrical responses.
- The RF ground connections should be kept as short as possible and connected to directly to a good RF ground for best performance.
- L_{ESD} provides a means to increase the ESD protection on a specific RF port, typically the port attached to the antenna.

TYPICAL CHARACTERISTICS

($T_A = +25^\circ\text{C}$, DC blocking capacitors = 56 pF, unless otherwise specified)

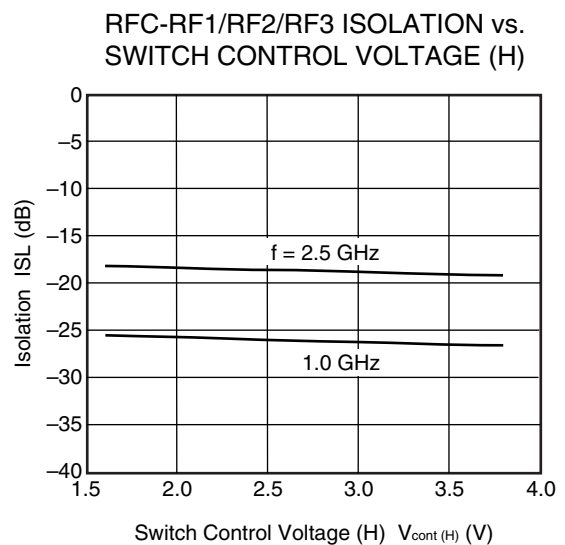
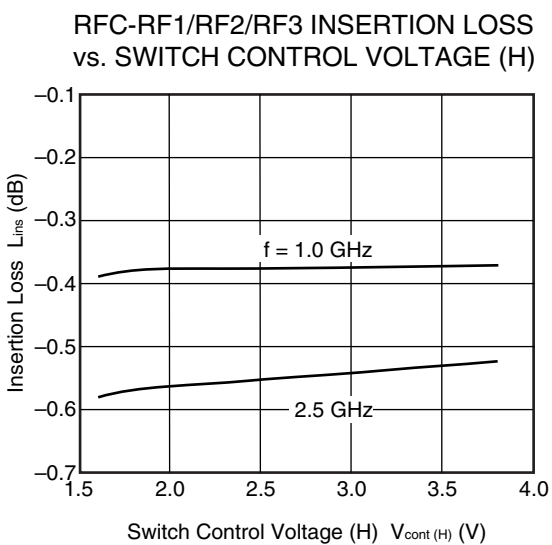
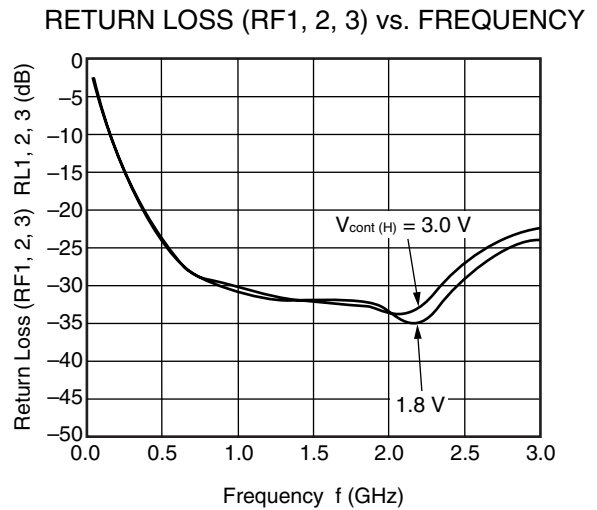
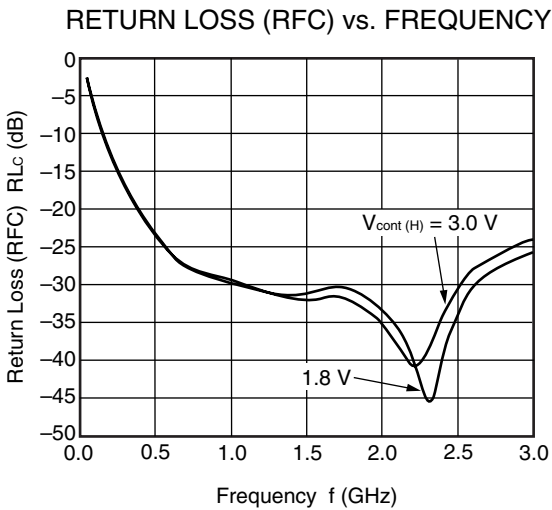
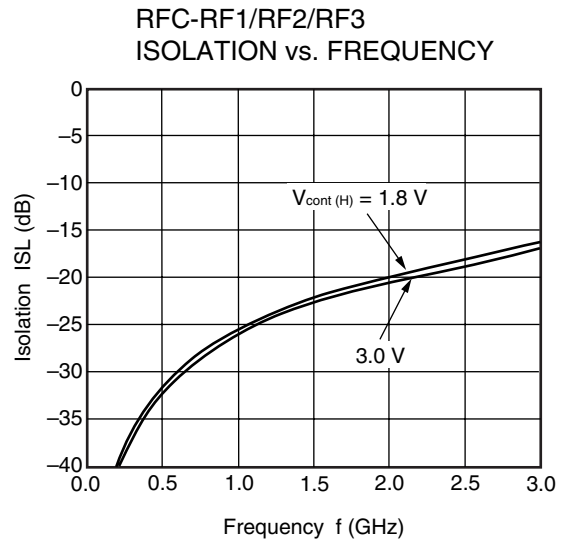
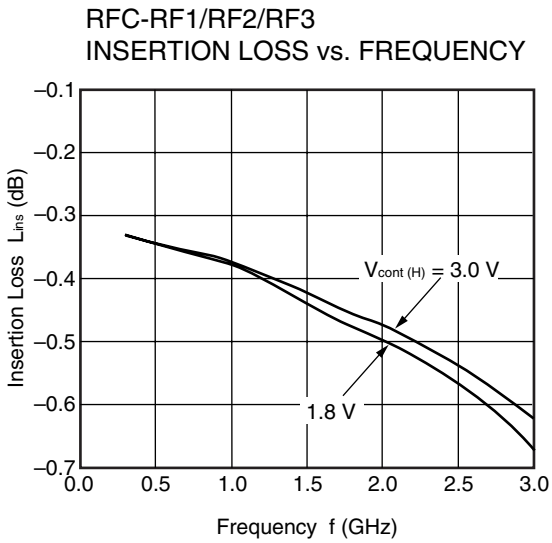

Remark The graphs indicate nominal characteristics.

RETURN LOSS (RFC)
vs. SWITCH CONTROL VOLTAGE (H)

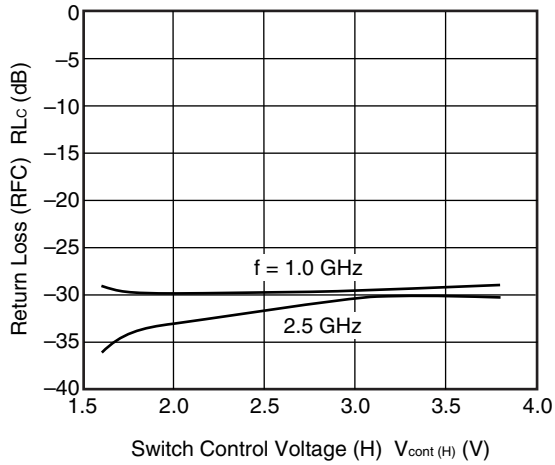

RETURN LOSS (RF1, 2, 3)
vs. SWITCH CONTROL VOLTAGE (H)

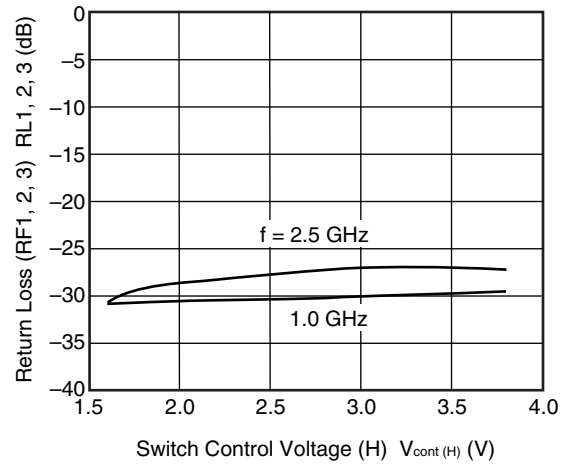

RFC-RF1/RF2/RF3 INSERTION LOSS,
 I_{cont} vs. INPUT POWER

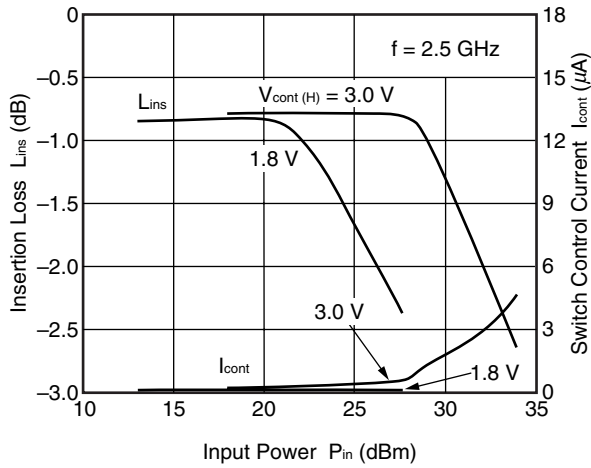

RFC-RF1/RF2/RF3 P_{in} (1 dB), P_{in} (0.1 dB) vs.
SWITCH CONTROL VOLTAGE (H)

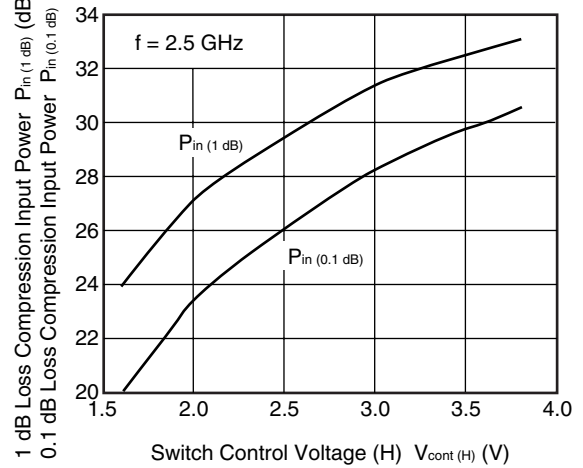

Remark The graphs indicate nominal characteristics.

MOUNTING PAD LAYOUT DIMENSIONS

8-PIN PLASTIC TSON (UNIT: mm)

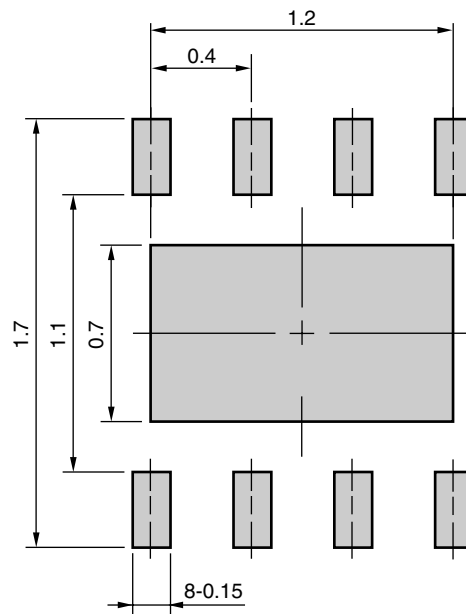

Remark The mounting pad layout in this document is for reference only.
When designing PCB, please consider workability of mounting, solder joint reliability, prevention of solder bridge and so on, in order to optimize the design.

PACKAGE DIMENSIONS

8-PIN PLASTIC TSON (UNIT: mm)

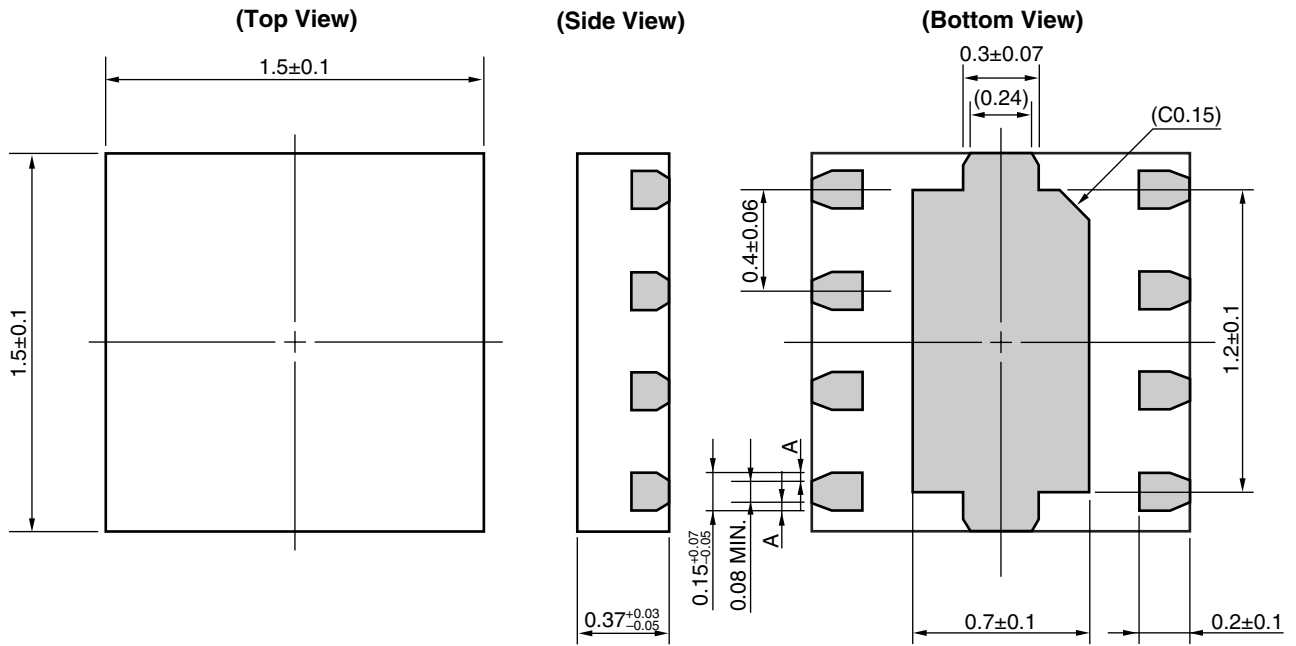

Remark $A > 0$
(): Reference value

RECOMMENDED SOLDERING CONDITIONS

This product should be soldered and mounted under the following recommended conditions. For soldering methods and conditions other than those recommended below, contact your nearby sales office.

Soldering Method	Soldering Conditions	Condition Symbol
Infrared Reflow	Peak temperature (package surface temperature) : 260°C or below Time at peak temperature : 10 seconds or less Time at temperature of 220°C or higher : 60 seconds or less Preheating time at 120 to 180°C : 120±30 seconds Maximum number of reflow processes : 3 times Maximum chlorine content of rosin flux (% mass) : 0.2%(Wt.) or below	IR260
Partial Heating	Peak temperature (terminal temperature) : 350°C or below Soldering time (per side of device) : 3 seconds or less Maximum chlorine content of rosin flux (% mass) : 0.2%(Wt.) or below	HS350

CAUTION

Do not use different soldering methods together (except for partial heating).

Caution	GaAs Products	<p>This product uses gallium arsenide (GaAs). GaAs vapor and powder are hazardous to human health if inhaled or ingested, so please observe the following points.</p> <ul style="list-style-type: none">• Follow related laws and ordinances when disposing of the product. If there are no applicable laws and/or ordinances, dispose of the product as recommended below.<ol style="list-style-type: none">1. Commission a disposal company able to (with a license to) collect, transport and dispose of materials that contain arsenic and other such industrial waste materials.2. Exclude the product from general industrial waste and household garbage, and ensure that the product is controlled (as industrial waste subject to special control) up until final disposal.• Do not burn, destroy, cut, crush, or chemically dissolve the product.• Do not lick the product or in any way allow it to enter the mouth.
----------------	---------------	--

Revision History	μPG2413T6Z Data Sheet
-------------------------	------------------------------

Rev.	Date	Description	
		Page	Summary
1.00	May 20, 2010	–	First edition issued

Bluetooth is a trademark owned by Bluetooth SIG, Inc., U.S.A.

All trademarks and registered trademarks are the property of their respective owners.

Notice

- All information included in this document is current as of the date this document is issued. Such information, however, is subject to change without any prior notice. Before purchasing or using any Renesas Electronics products listed herein, please confirm the latest product information with a Renesas Electronics sales office. Also, please pay regular and careful attention to additional and different information to be disclosed by Renesas Electronics such as that disclosed through our website.
- Renesas Electronics does not assume any liability for infringement of patents, copyrights, or other intellectual property rights of third parties by or arising from the use of Renesas Electronics products or technical information described in this document. No license, express, implied or otherwise, is granted hereby under any patents, copyrights or other intellectual property rights of Renesas Electronics or others.
- You should not alter, modify, copy, or otherwise misappropriate any Renesas Electronics product, whether in whole or in part.
- Descriptions of circuits, software and other related information in this document are provided only to illustrate the operation of semiconductor products and application examples. You are fully responsible for the incorporation of these circuits, software, and information in the design of your equipment. Renesas Electronics assumes no responsibility for any losses incurred by you or third parties arising from the use of these circuits, software, or information.
- When exporting the products or technology described in this document, you should comply with the applicable export control laws and regulations and follow the procedures required by such laws and regulations. You should not use Renesas Electronics products or the technology described in this document for any purpose relating to military applications or use by the military, including but not limited to the development of weapons of mass destruction. Renesas Electronics products and technology may not be used for or incorporated into any products or systems whose manufacture, use, or sale is prohibited under any applicable domestic or foreign laws or regulations.
- Renesas Electronics has used reasonable care in preparing the information included in this document, but Renesas Electronics does not warrant that such information is error free. Renesas Electronics assumes no liability whatsoever for any damages incurred by you resulting from errors in or omissions from the information included herein.
- Renesas Electronics products are classified according to the following three quality grades: "Standard", "High Quality", and "Specific". The recommended applications for each Renesas Electronics product depends on the product's quality grade, as indicated below. You must check the quality grade of each Renesas Electronics product before using it in a particular application. You may not use any Renesas Electronics product for any application categorized as "Specific" without the prior written consent of Renesas Electronics. Further, you may not use any Renesas Electronics product for any application for which it is not intended without the prior written consent of Renesas Electronics. Renesas Electronics shall not be in any way liable for any damages or losses incurred by you or third parties arising from the use of any Renesas Electronics product for an application categorized as "Specific" or for which the product is not intended where you have failed to obtain the prior written consent of Renesas Electronics. The quality grade of each Renesas Electronics product is "Standard" unless otherwise expressly specified in a Renesas Electronics data sheets or data books, etc.
"Standard": Computers; office equipment; communications equipment; test and measurement equipment; audio and visual equipment; home electronic appliances; machine tools; personal electronic equipment; and industrial robots.
"High Quality": Transportation equipment (automobiles, trains, ships, etc.); traffic control systems; anti-disaster systems; anti-crime systems; safety equipment; and medical equipment not specifically designed for life support.
"Specific": Aircraft; aerospace equipment; submersible repeaters; nuclear reactor control systems; medical equipment or systems for life support (e.g. artificial life support devices or systems), surgical implantations, or healthcare intervention (e.g. excision, etc.), and any other applications or purposes that pose a direct threat to human life.
- You should use the Renesas Electronics products described in this document within the range specified by Renesas Electronics, especially with respect to the maximum rating, operating supply voltage range, movement power voltage range, heat radiation characteristics, installation and other product characteristics. Renesas Electronics shall have no liability for malfunctions or damages arising out of the use of Renesas Electronics products beyond such specified ranges.
- Although Renesas Electronics endeavors to improve the quality and reliability of its products, semiconductor products have specific characteristics such as the occurrence of failure at a certain rate and malfunctions under certain use conditions. Further, Renesas Electronics products are not subject to radiation resistance design. Please be sure to implement safety measures to guard them against the possibility of physical injury, and injury or damage caused by fire in the event of the failure of a Renesas Electronics product, such as safety design for hardware and software including but not limited to redundancy, fire control and malfunction prevention, appropriate treatment for aging degradation or any other appropriate measures. Because the evaluation of microcomputer software alone is very difficult, please evaluate the safety of the final products or system manufactured by you.
- Please contact a Renesas Electronics sales office for details as to environmental matters such as the environmental compatibility of each Renesas Electronics product. Please use Renesas Electronics products in compliance with all applicable laws and regulations that regulate the inclusion or use of controlled substances, including without limitation, the EU RoHS Directive. Renesas Electronics assumes no liability for damages or losses occurring as a result of your noncompliance with applicable laws and regulations.
- This document may not be reproduced or duplicated, in any form, in whole or in part, without prior written consent of Renesas Electronics.
- Please contact a Renesas Electronics sales office if you have any questions regarding the information contained in this document or Renesas Electronics products, or if you have any other inquiries.
(Note 1) "Renesas Electronics" as used in this document means Renesas Electronics Corporation and also includes its majority-owned subsidiaries.
(Note 2) "Renesas Electronics product(s)" means any product developed or manufactured by or for Renesas Electronics.



SALES OFFICES

Renesas Electronics Corporation

<http://www.renesas.com>

Refer to "<http://www.renesas.com/>" for the latest and detailed information.

Renesas Electronics America Inc.
2880 Scott Boulevard Santa Clara, CA 95050-2554, U.S.A.
Tel: +1-408-588-6000, Fax: +1-408-588-6130

Renesas Electronics Canada Limited
1101 Nicholson Road, Newmarket, Ontario L3Y 9C3, Canada
Tel: +1-905-898-5441, Fax: +1-905-898-3220

Renesas Electronics Europe Limited
Dukes Meadow, Millboard Road, Bourne End, Buckinghamshire, SL8 5FH, U.K
Tel: +44-1628-585-100, Fax: +44-1628-585-900

Renesas Electronics Europe GmbH
Arcadiastrasse 10, 40472 Düsseldorf, Germany
Tel: +49-211-6503-0, Fax: +49-211-6503-1327

Renesas Electronics (China) Co., Ltd.
7th Floor, Quantum Plaza, No.27 ZhichunLu Haidian District, Beijing 100083, P.R.China
Tel: +86-10-8235-1155, Fax: +86-10-8235-7679

Renesas Electronics (Shanghai) Co., Ltd.
Unit 204, 205, AZIA Center, No.1233 Lujiazui Ring Rd., Pudong District, Shanghai 200120, China
Tel: +86-21-5877-1818, Fax: +86-21-6887-7858 / -7898

Renesas Electronics Hong Kong Limited
Unit 1601-1613, 16/F., Tower 2, Grand Century Place, 193 Prince Edward Road West, Mongkok, Kowloon, Hong Kong
Tel: +852-2886-9318, Fax: +852-2886-9022/9044

Renesas Electronics Taiwan Co., Ltd.
7F, No. 363 Fu Shing North Road Taipei, Taiwan, R.O.C.
Tel: +886-2-8175-9600, Fax: +886-2-8175-9670

Renesas Electronics Singapore Pte. Ltd.
1 HarbourFront Avenue, #06-10, Keppel Bay Tower, Singapore 098632
Tel: +65-6213-0200, Fax: +65-6278-8001

Renesas Electronics Malaysia Sdn.Bhd.
Unit 906, Block B, Menara Amcorp, Amcorp Trade Centre, No. 18, Jln Persiaran Barat, 46050 Petaling Jaya, Selangor Darul Ehsan, Malaysia
Tel: +60-3-7955-9390, Fax: +60-3-7955-9510

Renesas Electronics Korea Co., Ltd.
11F., Samik Laviel'or Bldg., 720-2 Yeoksam-Dong, Kangnam-Ku, Seoul 135-080, Korea
Tel: +82-2-558-3737, Fax: +82-2-558-5141