

Applications

- Commercial and Military Radar
- Communications

Product Features

- Frequency Range: 6 – 12 GHz
- NF: 2 dB
- P1dB: 19 dBm
- OTOI: 28 dBm
- Small Signal Gain: 22 dB
- Return Loss: >7 dB
- Bias: $V_D = 10\text{ V}$, $I_{DQ} = 100\text{ mA}$, $V_G = -2.3\text{ V}$ Typical
- Package Dimensions: 4 x 4 x 0.85 mm

General Description

TriQuint's TGA2612-SM is a packaged broadband Low Noise Amplifier fabricated on TriQuint's TQGaN25 0.25um GaN on SiC process. Covering 6–12 GHz, the TGA2612-SM typically provides >23 dM small signal gain, 19 dBm P1dB, and 27 dBm OTOI with <2 dB of Noise Figure. In addition to the high electrical performance, this GaN amplifier also provides a high level of input power robustness. Able to survive up to 2W of input power without performance degradation, TriQuint's TGA2612-SM provides flexibility regarding receive chain protection resulting in lower costs and reduced board space.

The TGA2612-SM is available in a surface mount 20-lead 4x4mm QFN. It is ideally suited for both radar and communications applications.

Fully matched to 50 ohms with integrated DC blocking caps on both I/O ports, the TGA2612-SM is ideally suited for both military and commercial radar and communications applications.

Lead-free and RoHS compliant

Evaluation Boards are available upon request.



Functional Block Diagram

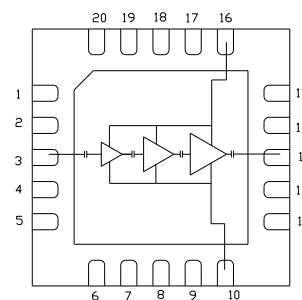

Pad Configuration

Pad No.	Symbol
1, 2, 4-9, 11, 12, 14, 15, 17-20	N/C
3	RF _{IN}
10	V _G
13	RF _{OUT}
16	V _D

Ordering Information

Part	ECCN	Description
TGA2612-SM	EAR99	6 – 12 GHz GaN LNA

Absolute Maximum Ratings

Parameter	Value
Drain Voltage (V_D)	40 V
Gate Voltage Range (V_G)	-5 to 0 V
Drain Current (I_D)	300 mA
Gate Current (I_G)	-1 to 7 mA
Power Dissipation, 85 °C (P_{DISS})	6 W
Input Power, CW, 50 Ω , (P_{IN})	33 dBm
Channel temperature (T_{CH})	275 °C
Mounting Temperature (30 Seconds)	260 °C
Storage Temperature	-55 to 150 °C

Operation of this device outside the parameter ranges given above may cause permanent damage. These are stress ratings only, and functional operation of the device at these conditions is not implied.

Recommended Operating Conditions

Parameter	Value
Drain Voltage (V_D)	10 V
Drain Current (I_{DQ})	100 mA
Gate Voltage (V_G)	-2.3 V Typical
Temperature (T_{BASE})	-40 to 85 °C

Electrical specifications are measured at specified test conditions. Specifications are not guaranteed overall operating conditions.

Electrical Specifications

Test conditions unless otherwise noted: 25 °C, $V_D = 10$ V, $I_{DQ} = 100$ mA, $V_G = -2.3$ V Typical

Parameter	Min	Typical	Max	Units
Operation Frequency Range	6		12	GHz
Small Signal Gain		22		dB
Return Loss		>7		dB
Noise Figure		2		dB
Output Power at 1 dB Gain Compression		19		dBm
Output Power at $P_{IN} = 10$ dBm		25		dBm
Output TOI		28		dBm
Gain Temperature Coefficient		-0.05		dB/°C
Noise Figure Temperature Coefficient		0.01		dB/°C

Thermal and Reliability Information

Parameter	Test Conditions	Value	Units
Thermal Resistance (θ_{JC}) ⁽¹⁾	CW	17	°C/W
Channel Temperature, T_{CH} (Under RF)	$T_{baseplate} = 85\text{ °C}$, $V_D = 10\text{ V}$, $I_{DQ} = 100\text{ mA}$,	112	°C
Median Lifetime (T_M)	$I_{D_Drive} = 180\text{ mA}$, $P_{OUT} = 25\text{ dBm}$, $P_{IN} = 10\text{ dBm}$, $Freq = 11\text{ GHz}$, $P_{DISS} = 1.6\text{ W}$	1.8×10^{11}	Hrs

Notes:

1. Thermal resistance measured at back of package.

Median Lifetime

Test Conditions: $V_D = 40\text{ V}$; Failure Criteria is 10% reduction in I_{D_MAX}

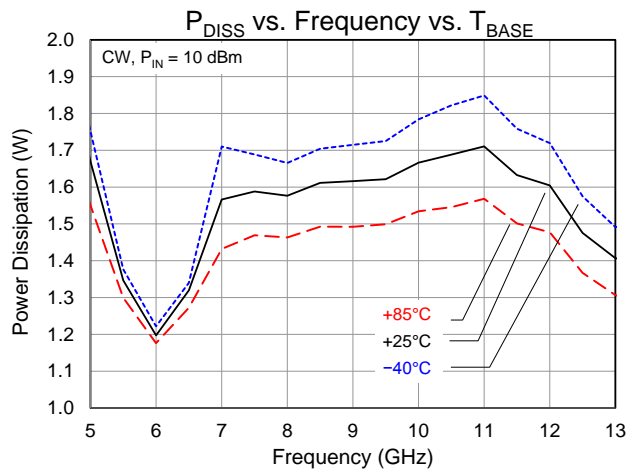
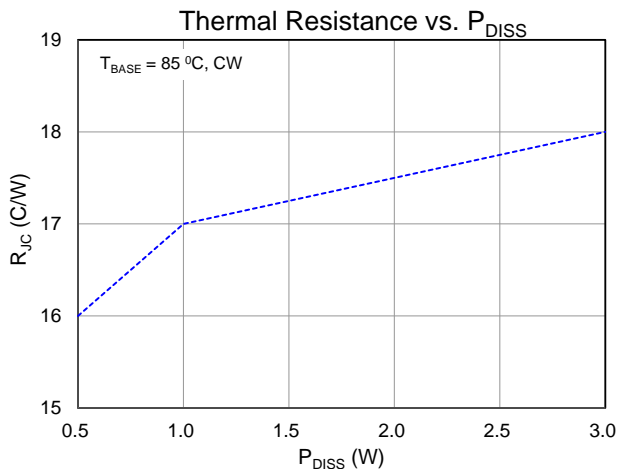
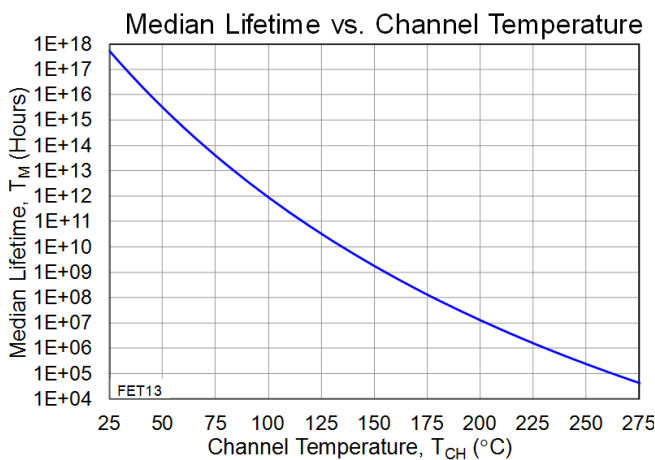

Typical Performance: Small Signal

Conditions unless otherwise specified: $V_D = 10\text{ V}$, $I_{DQ} = 100\text{ mA}$, $V_G = -2.3\text{ V}$ Typical

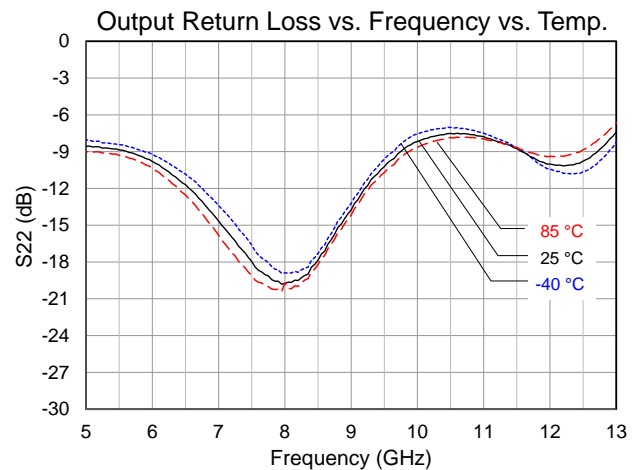
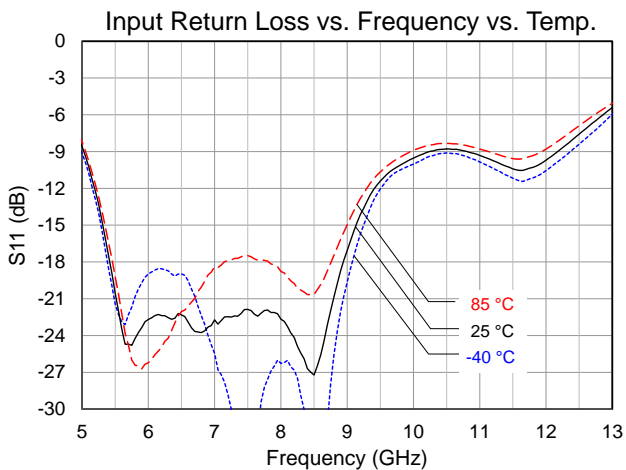
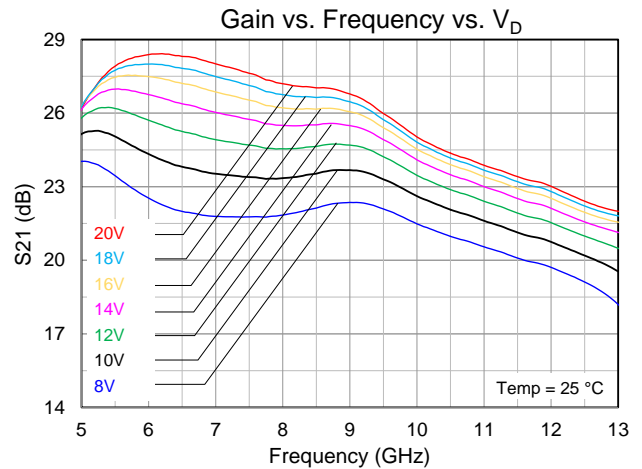
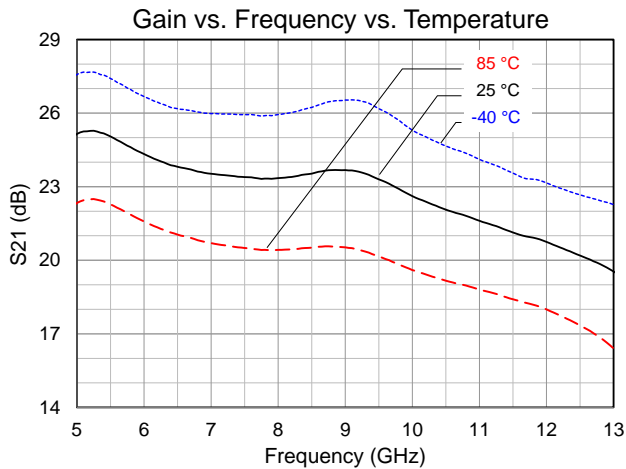
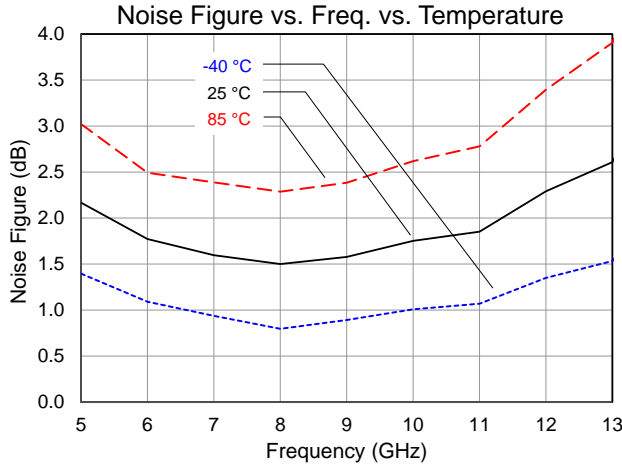

Typical Performance: Large Signal

Conditions unless otherwise specified: $V_D = 10\text{ V}$, $I_{DQ} = 100\text{ mA}$, $V_G = -2.3\text{ V}$ Typical

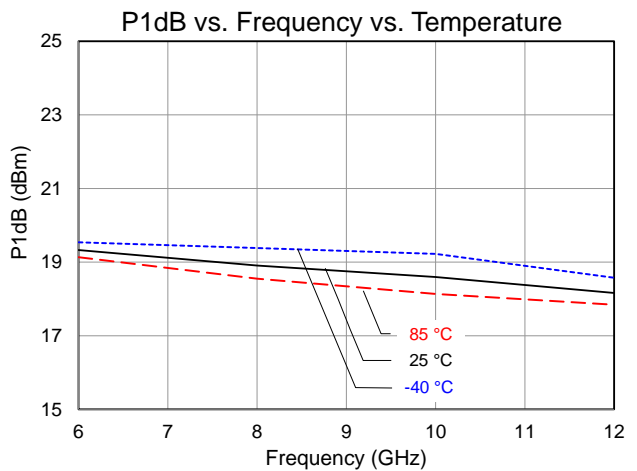
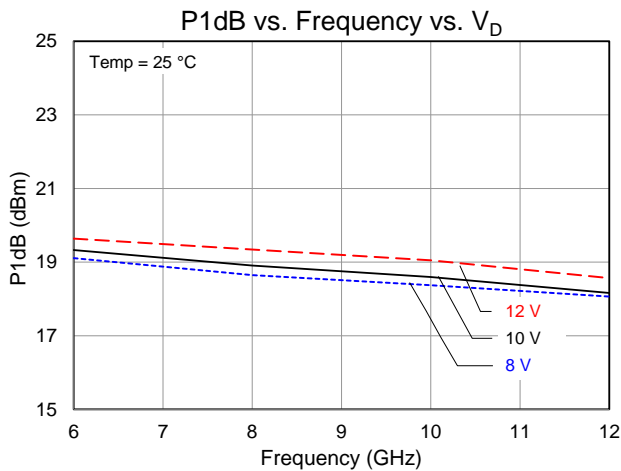
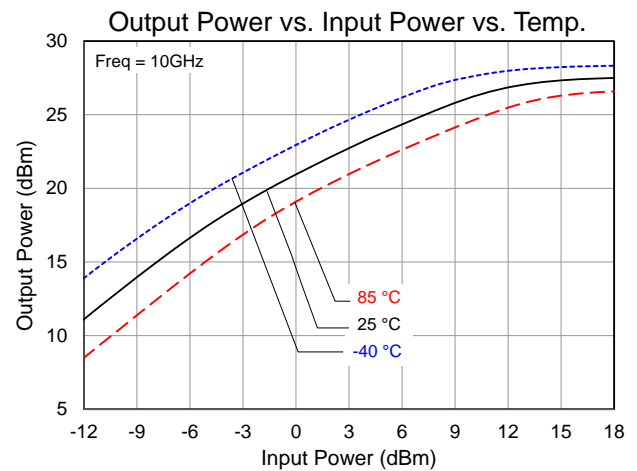
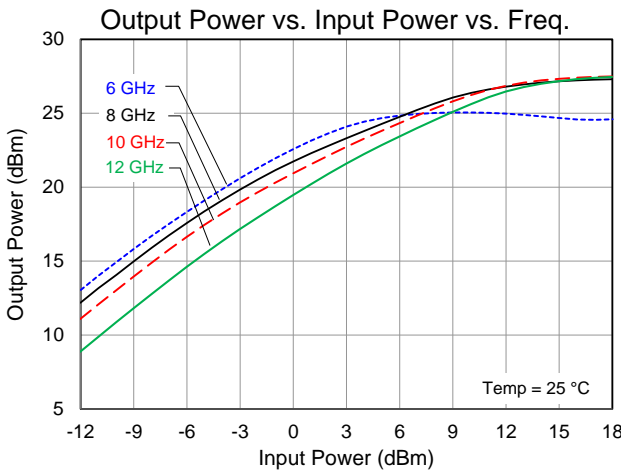
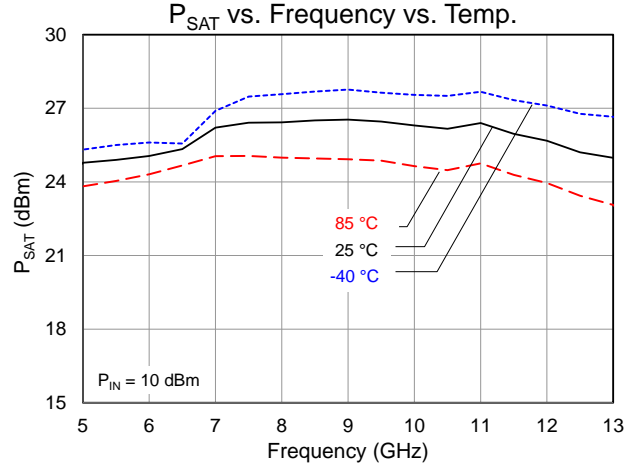
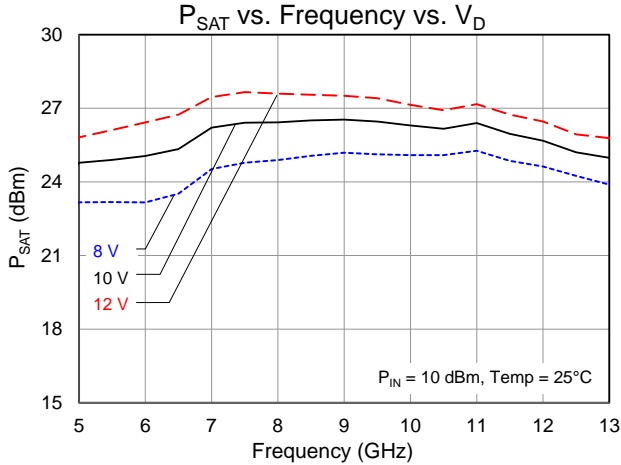

Typical Performance: Large Signal

Conditions unless otherwise specified: $V_D = 10\text{ V}$, $I_{DQ} = 100\text{ mA}$, $V_G = -2.3\text{ V}$ Typical

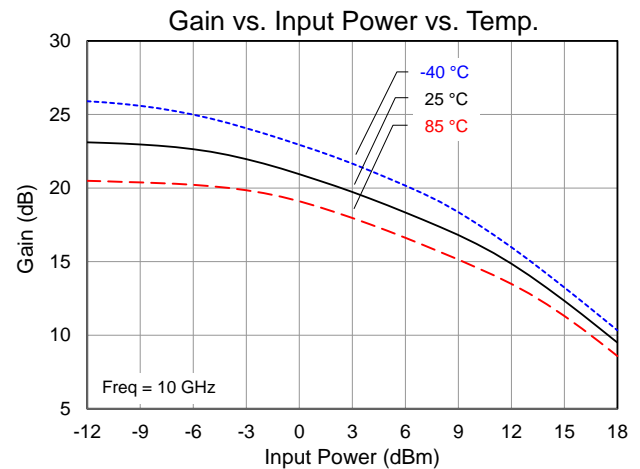
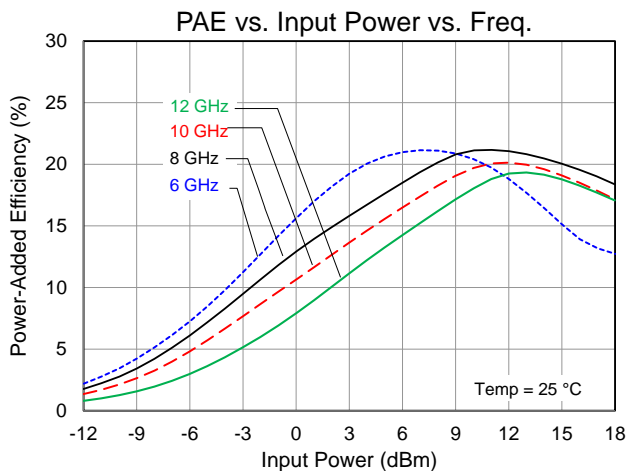
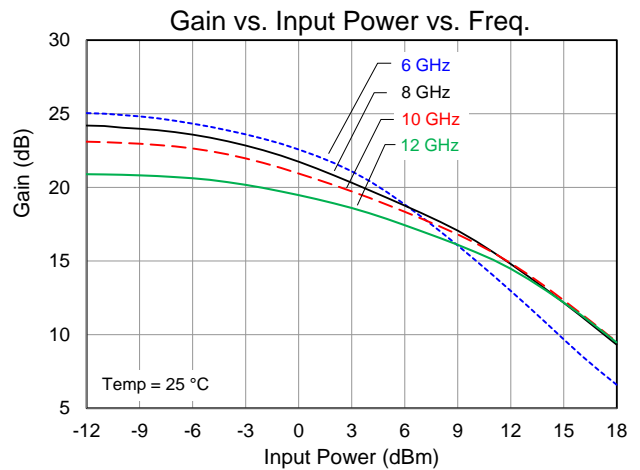
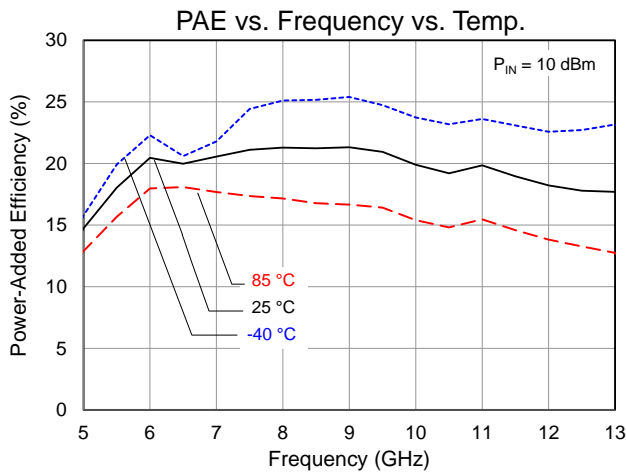
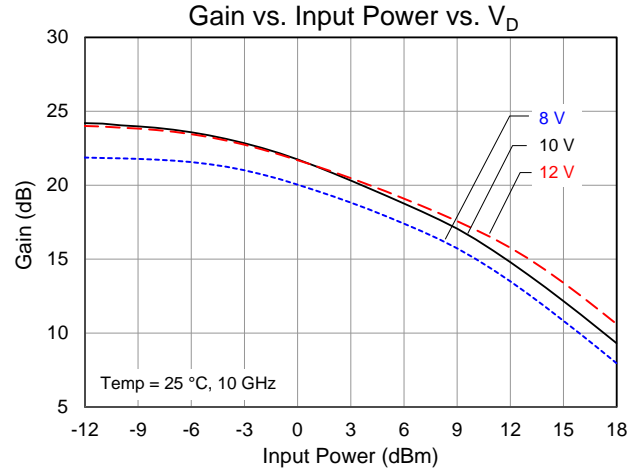
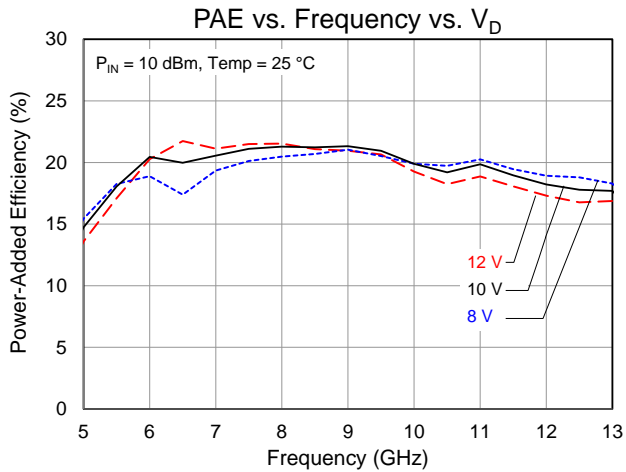

Typical Performance: Large Signal

Conditions unless otherwise specified: $V_D = 10\text{ V}$, $I_{DQ} = 100\text{ mA}$, $V_G = -2.3\text{ V}$ Typical

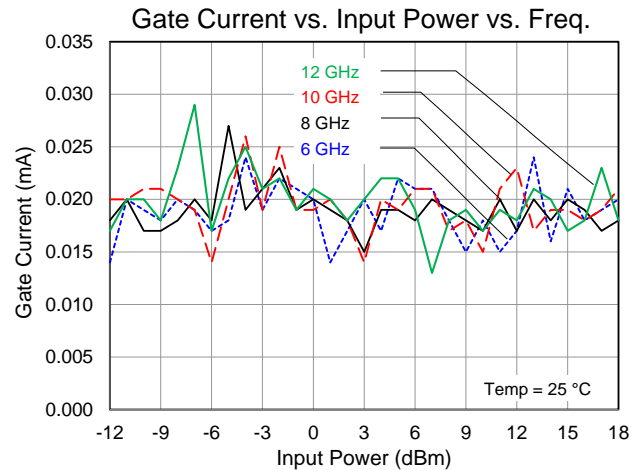
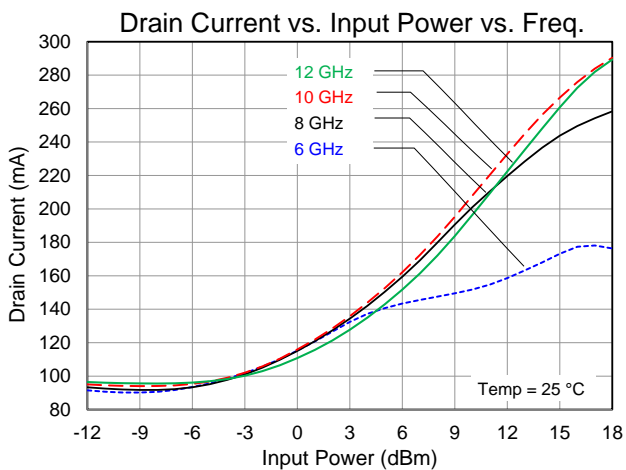
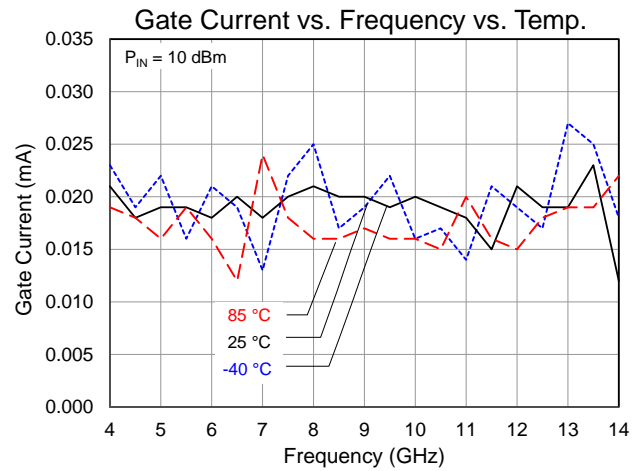
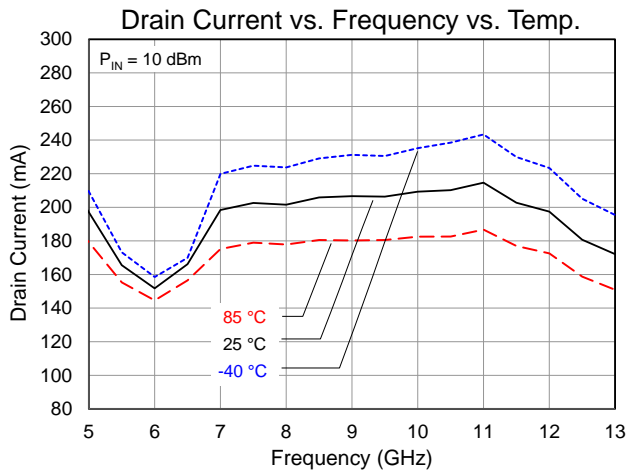
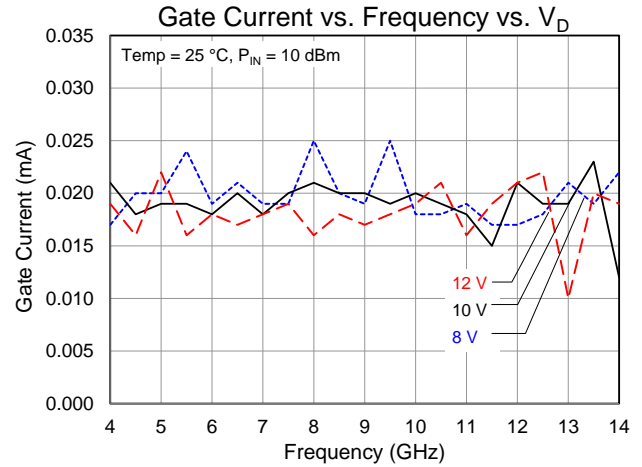
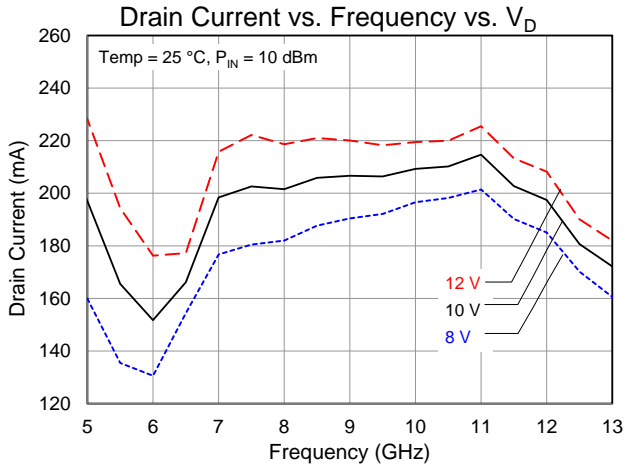

Typical Performance: Linearity

Conditions unless otherwise specified: $V_D = 10\text{ V}$, $I_{DQ} = 100\text{ mA}$, $V_G = -2.3\text{ V}$ Typical

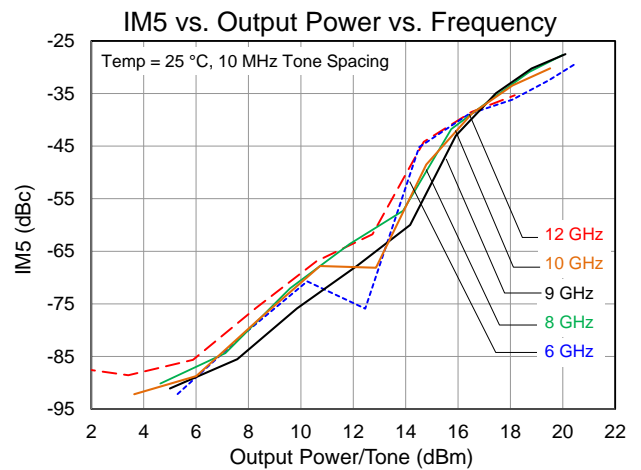
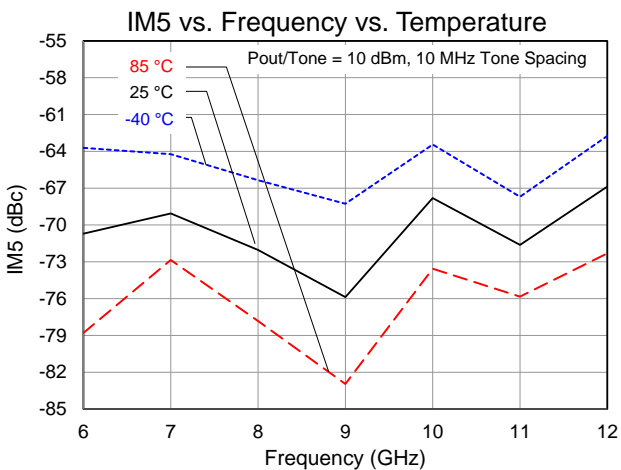
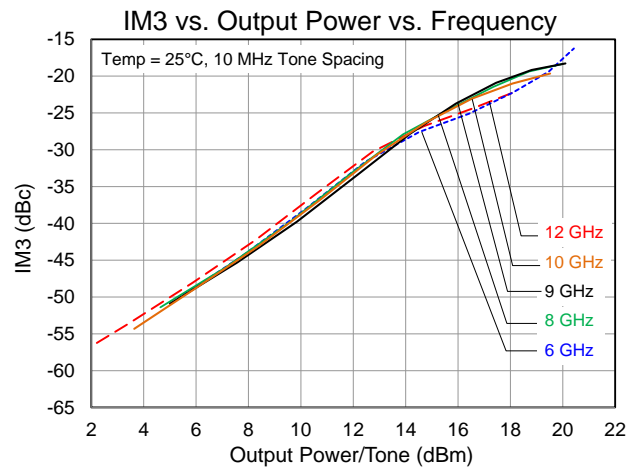
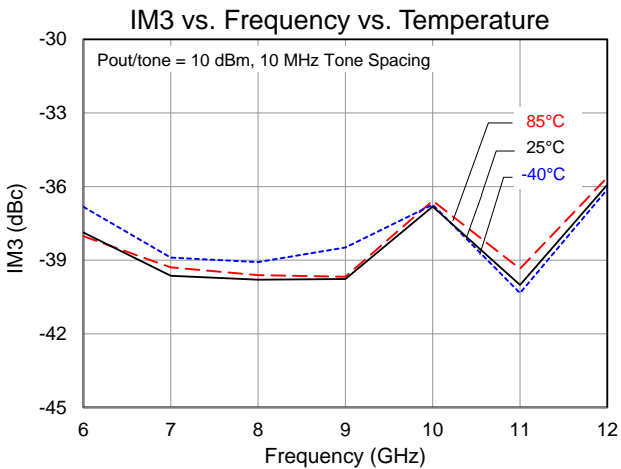
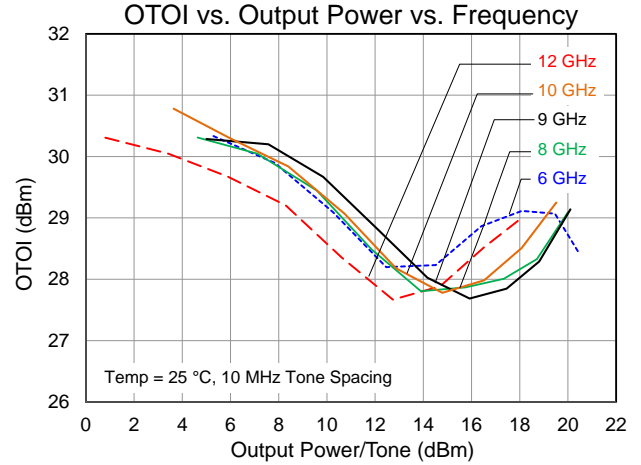
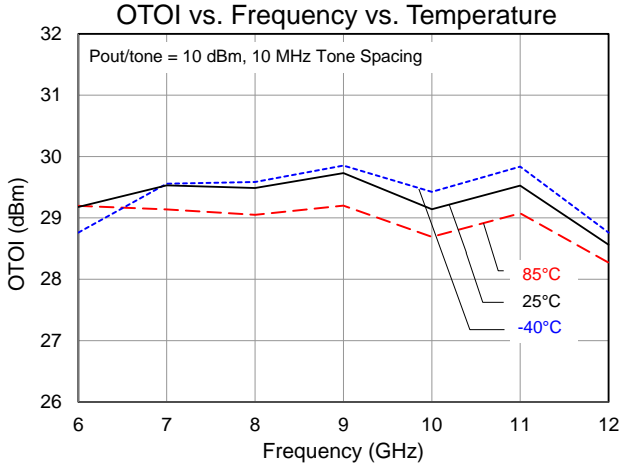

Typical Performance: Harmonics

Conditions unless otherwise specified: $V_D = 10\text{ V}$, $I_{DQ} = 100\text{ mA}$, $V_G = -2.3\text{ V}$ Typical

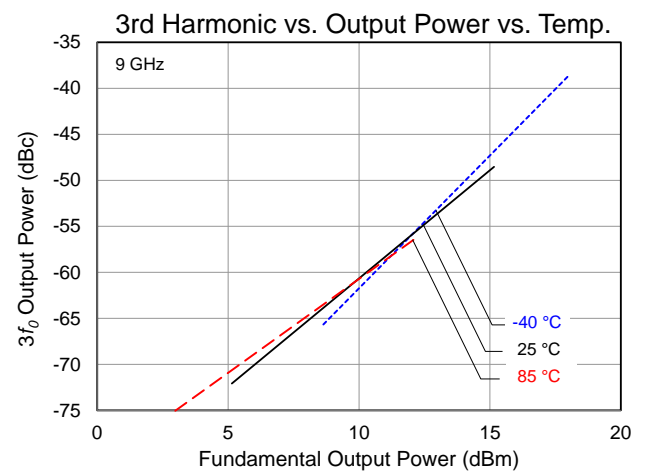
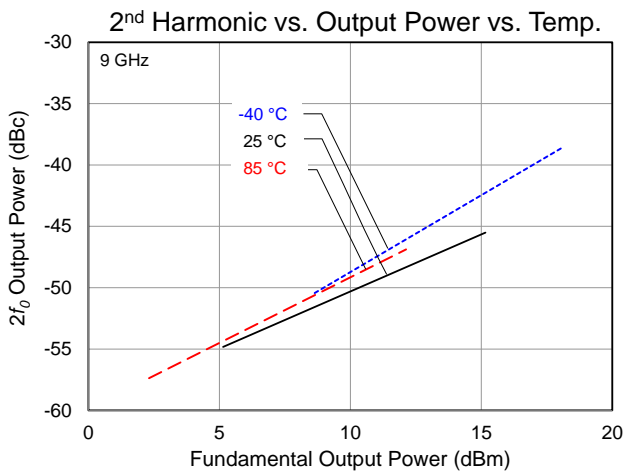
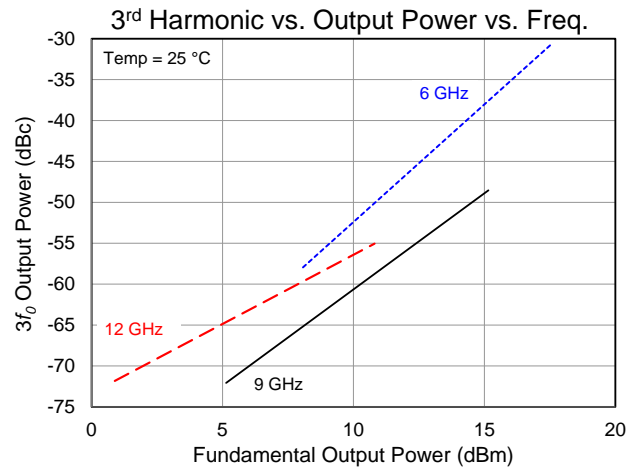
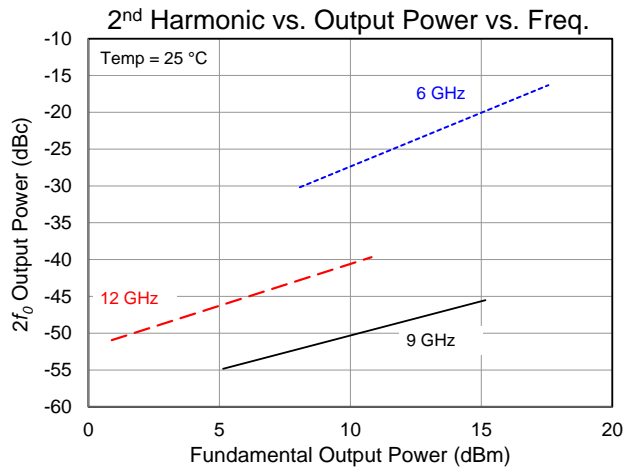

Application Information

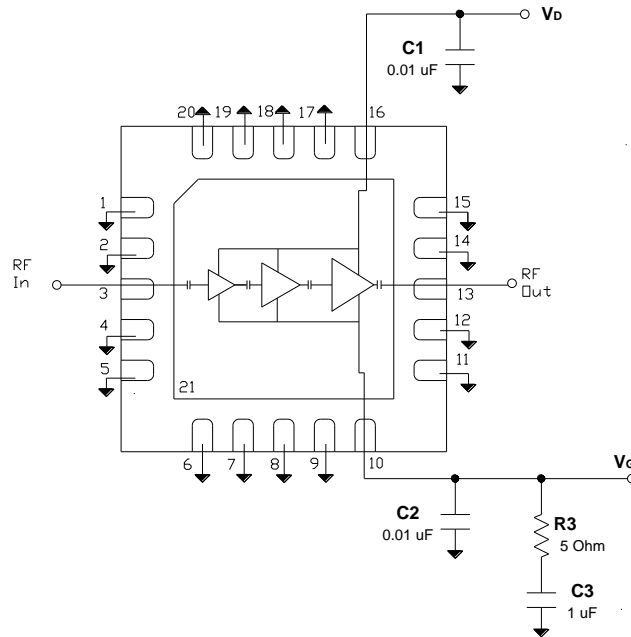

Bias-up Procedure

1. Set I_D limit to 300 mA, I_G limit to 1mA
2. Apply -5 V to V_G for pinch off
3. Apply +10 V to V_D
4. Adjust V_G more positive until $I_{DQ} = 100$ mA ($V_G \sim -2.3$ V Typical)
5. Apply RF signal

Bias-down Procedure

1. Turn off RF signal
2. Reduce V_G to -5 V. Ensure $I_{DQ} \sim 0$ mA
3. Set V_D to 0 V
4. Turn off V_D supply
5. Turn off V_G supply

Pin Description

Pin No.	Symbol	Description
1, 2, 4-9, 11, 12, 14, 15, 17-20	N/C	Recommend grounding on the PCB
3	RF _{IN}	Input; matched to 50 Ω ; DC blocked
10	V_G	Gate voltage; bias network is required; see recommended Application Information above.
13	RF _{OUT}	Output; matched to 50 Ω ; DC blocked
16	V_D	Drain voltage; bias network is required; see recommended Application Information above.
21	Gnd	Ground Paddle. Multiple vias should be employed to minimize inductance and thermal resistance.

Evaluation Board

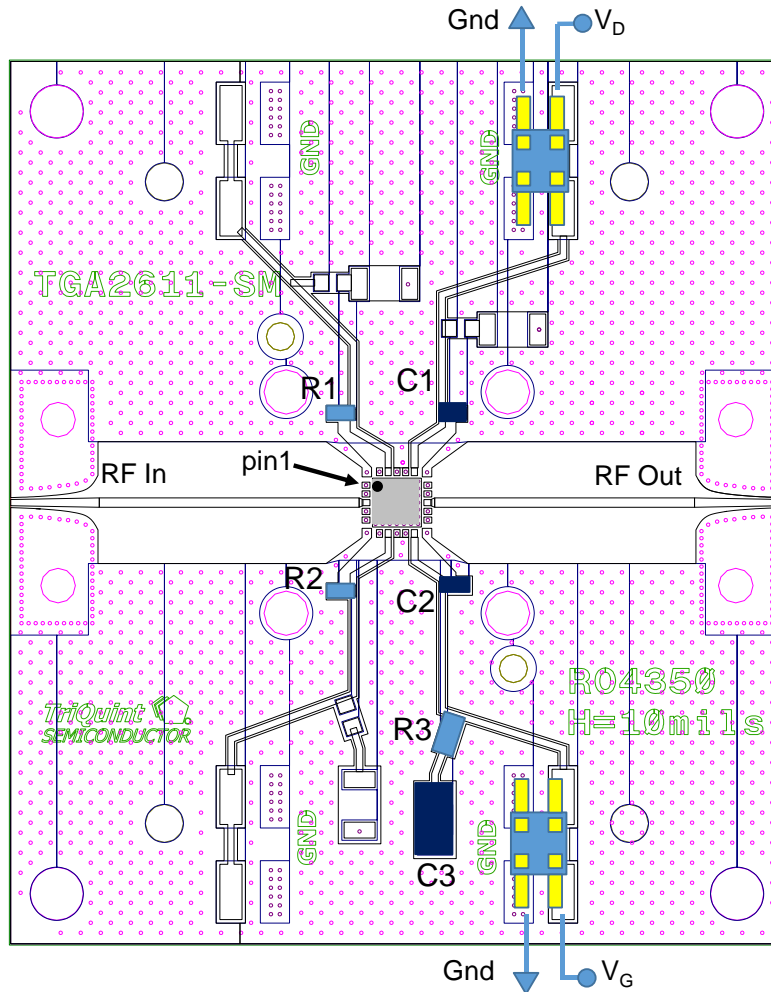

Bill of Material

Reference Des.	Value	Description	Manuf.	Part Number
C1, C2	0.01 μ F	Cap, 0402, 50 V, 10%, X7R	Various	
C3	1 μ F	Cap, 1206, 50 V, 10%, X7R	Various	
R1, R2	0 Ohms	Res, 0402, 5% (Required for above EVB design)	Various	
R3	5 Ohms	Res, 0603, 5%	Various	

Mechanical Information

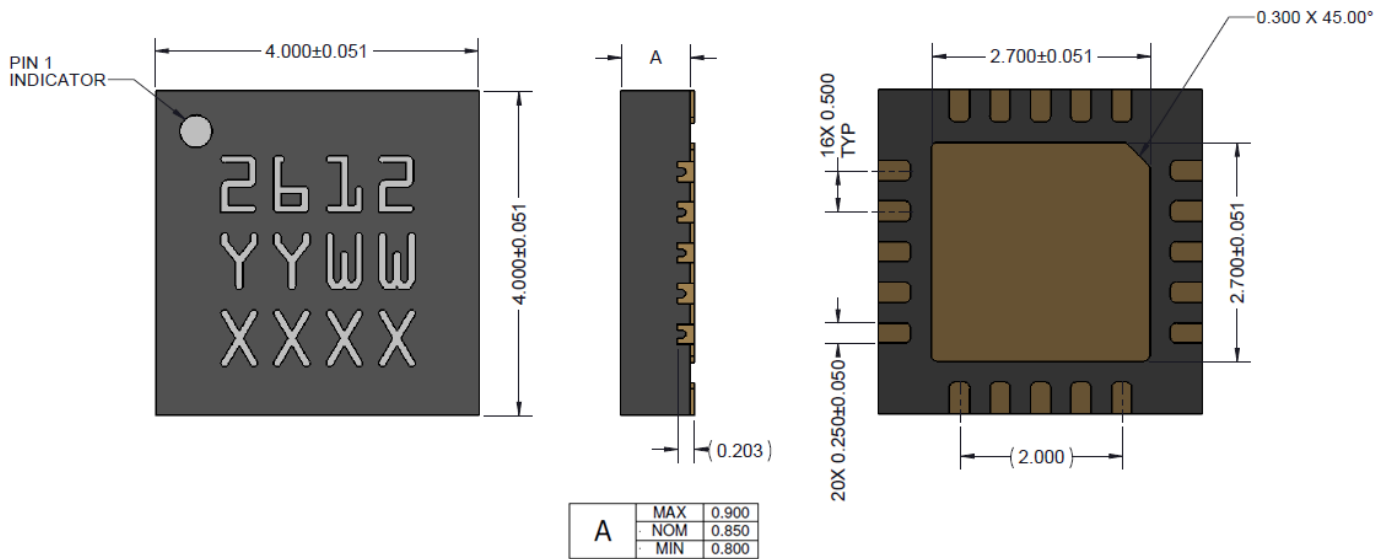

Units: mm

Tolerances: unless specified

x.xx = ± 0.25

x.xxx = ± 0.127

x.xxxx = ± 0.0254

angles = 0.5°

Materials:

Base: Cu alloy

All metalized features are NiPdAu plated

Part is mold encapsulated

Marking:

2612: Part number

YY: Part Assembly year

WW: Part Assembly week

XXXX: Lot ID

Recommended Soldering Temperature Profile

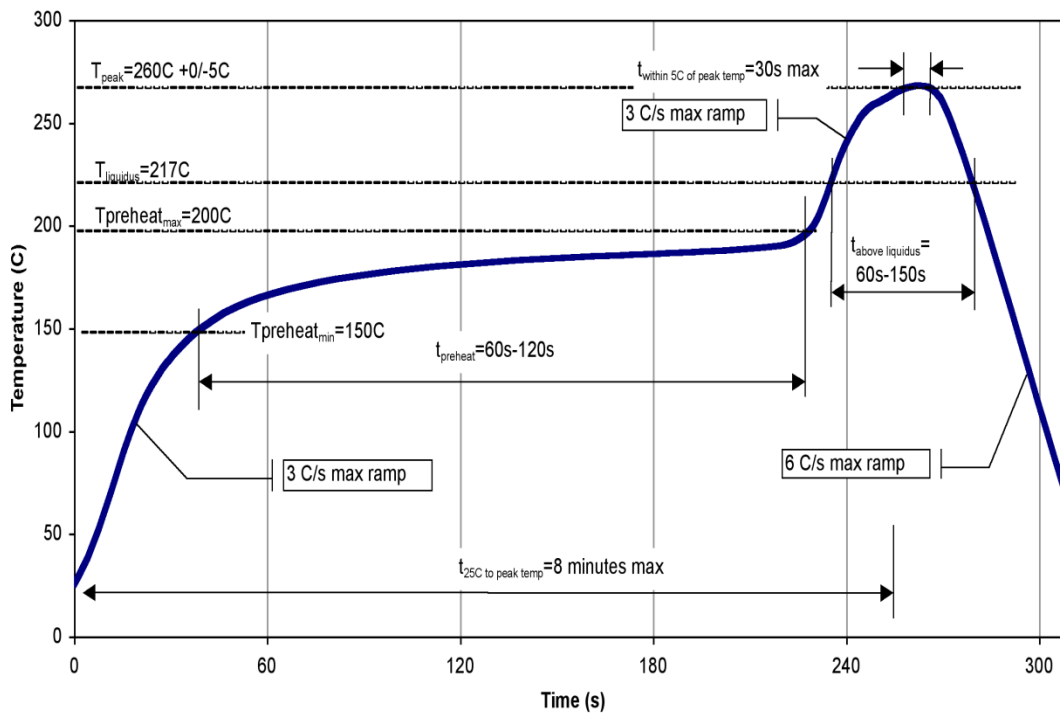

Product Compliance Information

ESD Sensitivity Ratings



Caution! ESD-Sensitive Device

ESD Rating: TBD
Value: TBD
Test: Human Body Model (HBM)
Standard: JEDEC Standard JESD22-A114

MSL Rating

Level TBD at TBD°C convection reflow
The part is rated Moisture Sensitivity Level TBD at TBD°C per JEDEC standard IPC/JEDEC J-STD-020.

ECCN

US Department of Commerce: EAR99

Solderability

Compatible with the latest version of J-STD-020, Lead-free solder, 260°C

RoHS Compliance

This part is compliant with EU 2002/95/EC RoHS directive (Restrictions on the Use of Certain Hazardous Substances in Electrical and Electronic Equipment).

This product also has the following attributes:

- Lead Free
- Halogen Free (Chlorine, Bromine)
- Antimony Free
- TBBP-A (C₁₅H₁₂Br₄O₂) Free
- PFOS Free
- SVHC Free

Contact Information

For the latest specifications, additional product information, worldwide sales and distribution locations, and information about TriQuint:

Web: www.triquint.com
Email: info-sales@triquint.com

Tel: +1.972.994.8465
Fax: +1.972.994.8504

For technical questions and application information: Email: info-products@triquint.com

Important Notice

The information contained herein is believed to be reliable. TriQuint makes no warranties regarding the information contained herein. TriQuint assumes no responsibility or liability whatsoever for any of the information contained herein. TriQuint assumes no responsibility or liability whatsoever for the use of the information contained herein. The information contained herein is provided "AS IS, WHERE IS" and with all faults, and the entire risk associated with such information is entirely with the user. All information contained herein is subject to change without notice. Customers should obtain and verify the latest relevant information before placing orders for TriQuint products. The information contained herein or any use of such information does not grant, explicitly or implicitly, to any party any patent rights, licenses, or any other intellectual property rights, whether with regard to such information itself or anything described by such information.

TriQuint products are not warranted or authorized for use as critical components in medical, life-saving, or life-sustaining applications, or other applications where a failure would reasonably be expected to cause severe personal injury or death.