

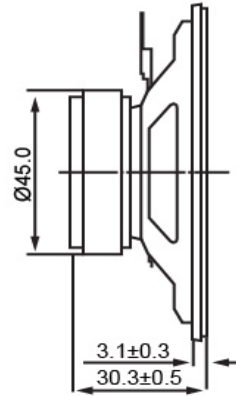

SIDE VIEW

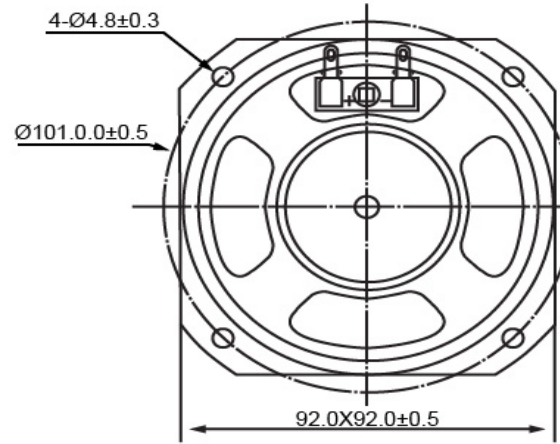

BOTTOM VIEW



Specifications			Notes	Revision History					
Description	Value	Unit		Version	Description	Date	Approved		
Shape	Rectangle		1) All dimensions are in mm unless otherwise noted 2) All parts meet RoHS 	1	Released from Engineering	10/21/2013	J.S		
Resonant Frequency	200	(Hz)							
Frequency Range	200 ~ 15,000	(Hz)							
SPL @ 10cm	89	(dBA)							
Impedance	4	(Ohm)							
Cone Material	Paper								
Nominal Power	2	(W)							
Max Power	3	(W)							
Mount Type	Frame								
Operating Temperature	-25 ~ +55	°C							
Storage Temperature	-25 ~ +55	°C							
Weight	134	(g)							
				Dynamic Speaker		SP920204-1			
				Drawn by	Date	Checked by	Date	Approved by	Date
				A.B.	10/21/2013	C.E.	10/21/2013	J.S	10/21/2013