

SODDERLUG DETAIL  
SCALE 2X

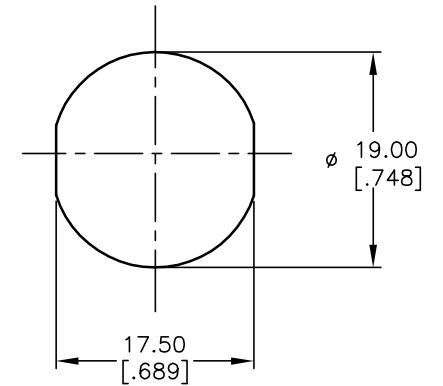

RECOMMENDED PANEL CUTOUT

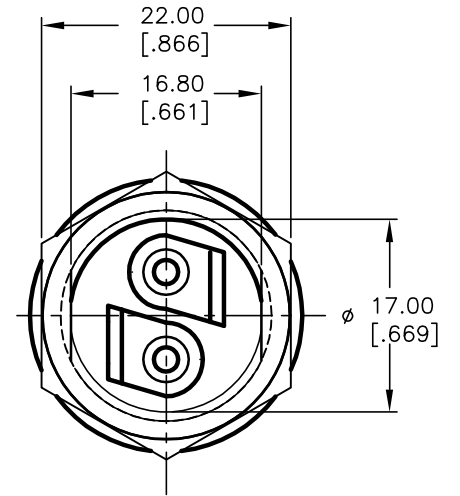
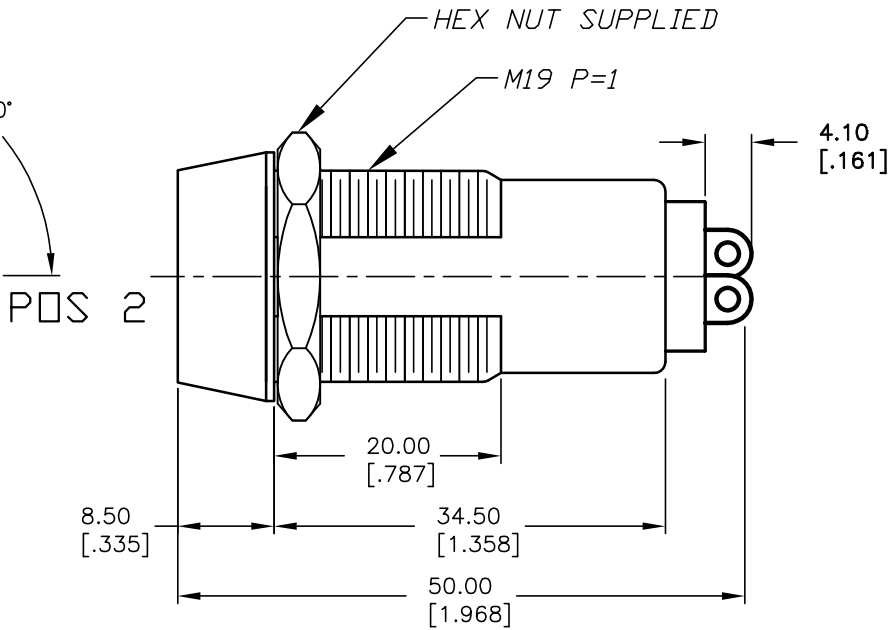
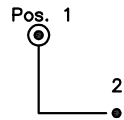

CIRCUIT: SPST  
CONTACT CONFIGURATION

| SWITCH FUNCTION |       |
|-----------------|-------|
| POS 1           | POS 2 |
| ↑               | →     |
| OFF             | ON    |

LEGEND

- = INDICATE NO KEY PULL
- ⊙ = INDICATES KEY PULL POSSIBLE

NOTES:

1. ALL DIMENSIONS IN MM [INCH]
2. GENERAL TOLERANCE: X.X=±0.4  
X.XX=±0.25
3. TERM. NOS. FOR REFERENCE ONLY.
4. RATING: 4A @125VAC, 2A @250VAC
5. CONTACT RESISTANCE: 10mILLI-OHMS
6. DIELECTRIC STRENGTH: 1500 VAC-1Minute
7. INSULATION RESISTANCE: 500 Mega-OHMS
8. MATERIALS:

HOUSING: ZINC ALLOY DIE CAST  
CYLINDER: ZINC ALLOY W/CHROME PLATING  
TERMINAL AND CONTACTS: SILVER PLATED  
TUMBLER: 5 DISC MECHANISM W/DUST SHUTTER  
KEYS 7309 (2): BRASS W/NICKEL PLATING  
DOUBLE CUT REVERSIBLE

**E-SWITCH®**

|       |         |    |         |     |             |         |    |         |     |
|-------|---------|----|---------|-----|-------------|---------|----|---------|-----|
| TITLE |         |    |         |     | K0119A-7309 |         |    |         |     |
| SCALE | DATE    | DR | DWG     | REV | SCALE       | DATE    | DR | DWG     | REV |
| 1.5:1 | 6/10/04 | AR | K200139 | A   | 1.5:1       | 6/10/04 | AR | K200139 | A   |

|      |         |                         |         |      |
|------|---------|-------------------------|---------|------|
| A    | 14089   | RELEASED FOR PRODUCTION | 6/10/04 | AR   |
| REV. | ECN No. | DESCRIPTION             | DATE    | CHKD |

THE INFORMATION CONTAINED IN THIS DOCUMENT IS PROPRIETARY TO E-SWITCH AND IS NOT TO BE COPIED OR TRANSFERRED