

LED SPECS	UNITS	GREEN ▲
FORWARD CURRENT	mA	20
FORWARD VOLTAGE @20mA	V	2.1-2.5
LUMINOUS INTENSITY @ 20mA	MCD	400

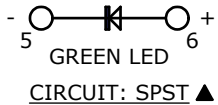

NOTES:

1. ALL DIMENSIONS IN MM [INCH]
2. GENERAL TOLERANCE: X.X=±0.4
X.XX=±0.25
3. RATING: 12VDC @ 50mA
4. CONTACT RESISTANCE: 100mΩ MAX.
5. INSULATION RESISTANCE: 100MΩ MIN.
- ▲ 6. OPERATING FORCE: 180± 50gf
7. TRAVEL: 0.2± 0.1mm
8. OPERATING TEMPERATURE: -20°C TO 70°C
9. OPERATING LIFE: 500,000 CYCLES
- ▲ 10. LED: GREEN
11. ▲ DENOTES CRITICAL PARAMETERS
12. 2002/95/EC (ROHS) COMPLIANT
13. PARTS TO BE PACKAGED 100 PARTS PER TRAY.

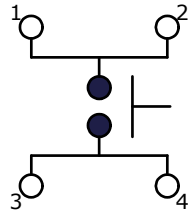
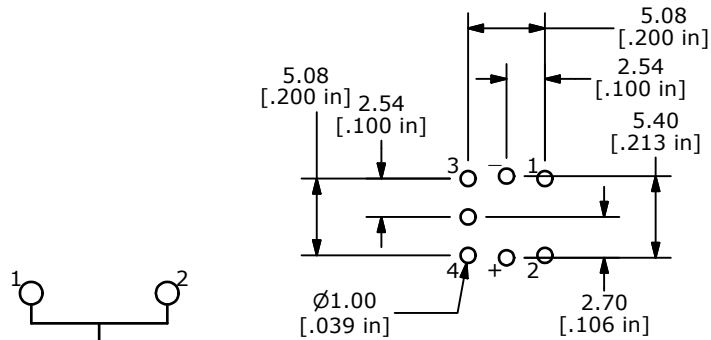
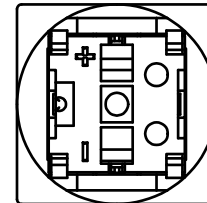
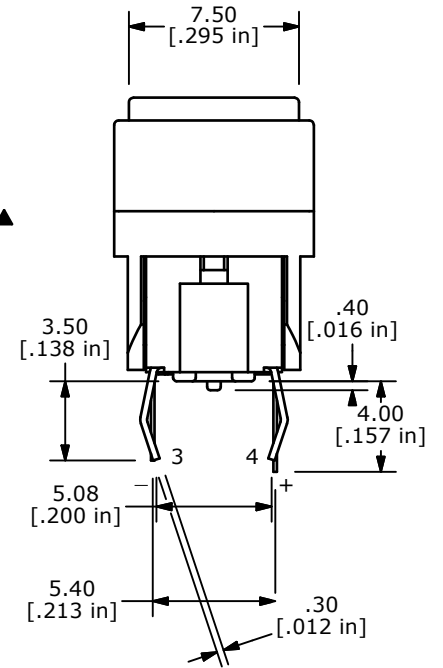
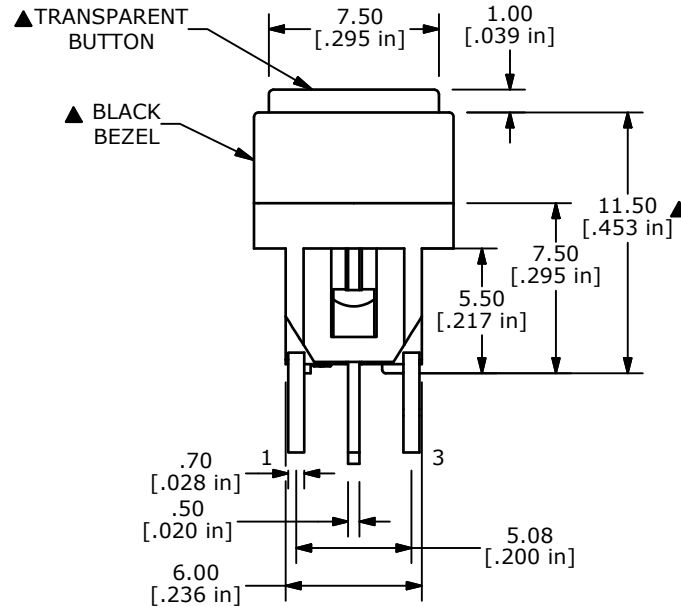
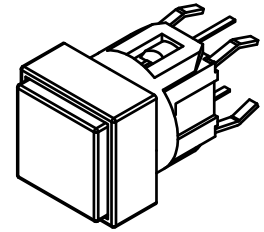
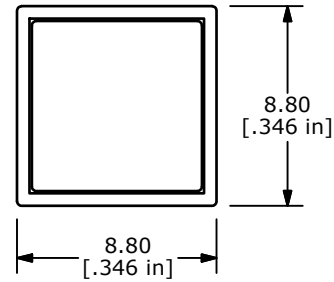

REV	PCR NO	DESCRIPTION	DATE	BY
C	20316	CORRECT BEZEL	12/01/11	BMA
B	20262	CHANGE DRAWING TITLE	11/07/11	BMA
A	20230	RELEASE FOR PRODUCTION	10/26/11	BMA

				
TITLE TL1220S2BBTGN				
SCALE	DATE	DR	DWG	REV
3	10/26/2011	BMA	B260017	C