

PHAP40 series

Momentary or latching action key switches

Distinctive features and specifications



- The smallest latching action switch of the range
- Audible “click”
- Models with 6 x 6 mm case on request

ELECTRICAL SPECIFICATIONS

- Max. current/voltage rating with resistive load : 100mA 30VDC
- Initial contact resistance : 100 mΩ max.
- Insulation resistance : 100 MΩ min. at 500VDC
- Dielectric strength : 500 Vrms min. (1 min.)
- Electrical life : 10.000 cycles

MATERIALS

- Case : polyamide
- Actuator : polyamide
- Contacts : brass, silver plated

GENERAL SPECIFICATIONS

- Travel : see next page.
- Wave soldering : 255°C, 5 seconds
- Manual soldering : 300°C ± 10°C, 3 seconds
- Operating force :
 - Model PHAP4673 : 1,4N ± 0,5N
 - Models PHAP4683 and PHAP4383V : 2N ± 0,5N
- Operating temperature : -20°C to +70°C

Dimensions : first dimensions are in mm while inches are shown as bracketed numbers.



Packaging unit : 1.000 pieces.

PHAP40 series

Momentary or latching action key switches

Straight PC terminals

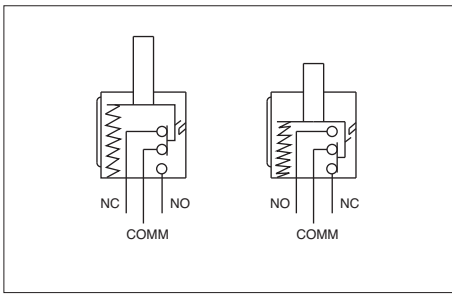

- Double pole, double throw
- Non-shorting contacts
- Moulded-in terminals

MODEL
STRUCTURE

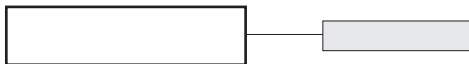

7 x 7 mm case



PHAP4673

ON - ON

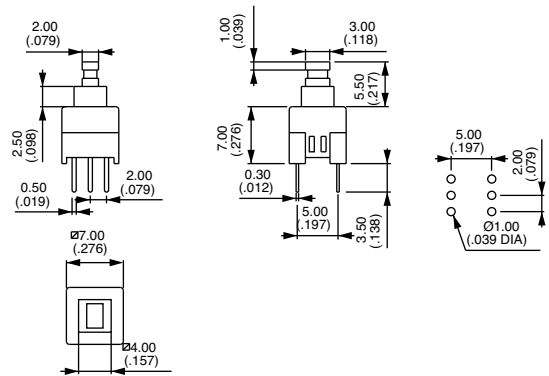

Pre-travel : 1 mm - Total travel : 1,8 mm

8,4 x 8,4 mm case



PHAP4683
PHAP4383V *

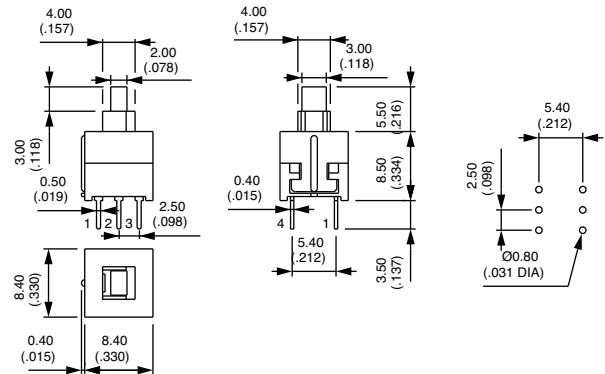
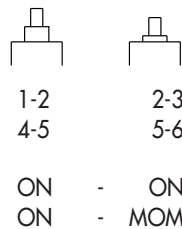

Total travel : 2,5 mm * Audible click

CAPS

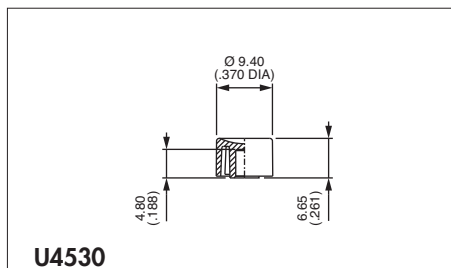
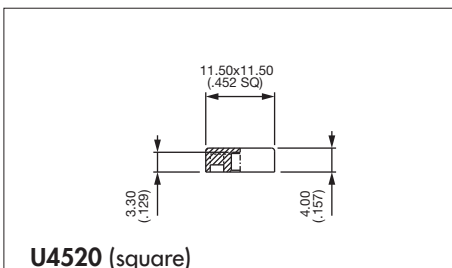

Cap colours

Replace "0" by number :

- 1 blue
- 2 black
- 3 green
- 4 grey
- 5 yellow
- 6 red
- 7 ivory
- 7/1 white
- 9 orange