

Leiterplatten-Layout Vorschlag für SMT
PCB-Layout Proposal for SMT

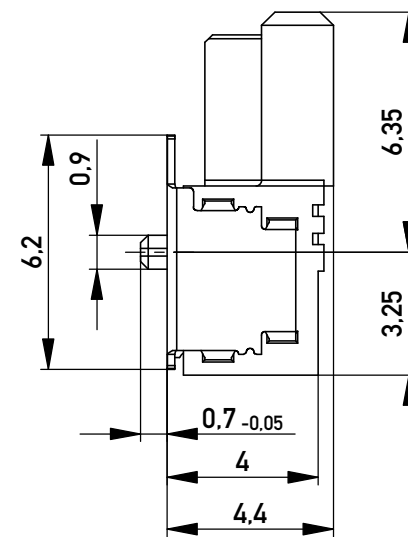
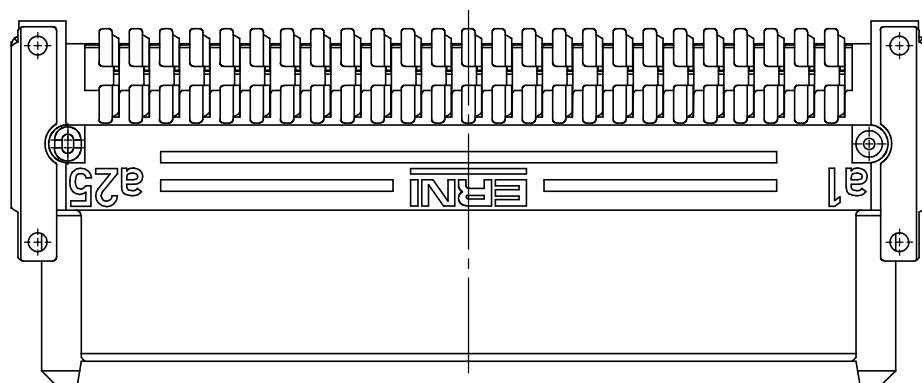
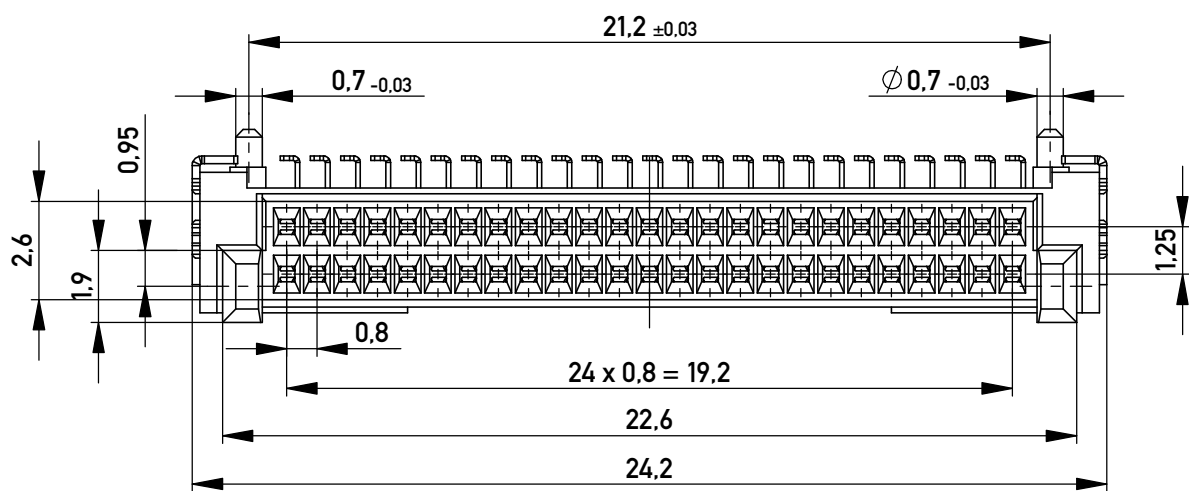
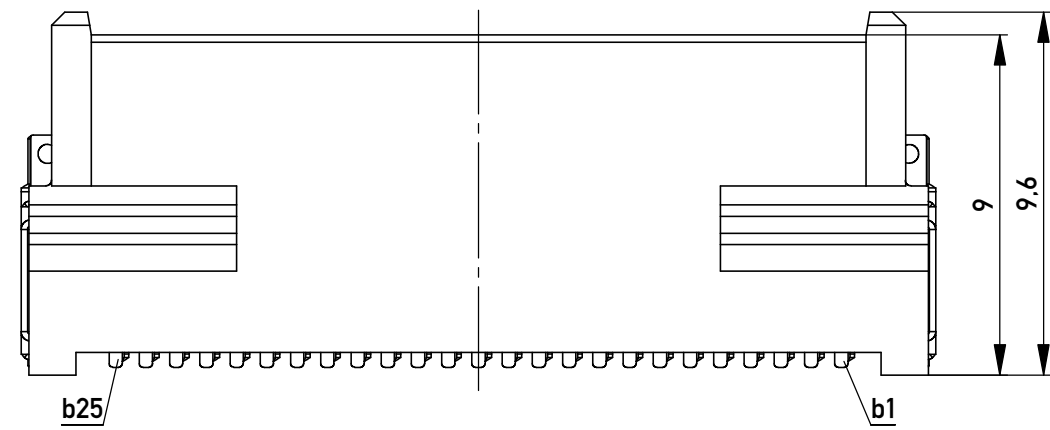
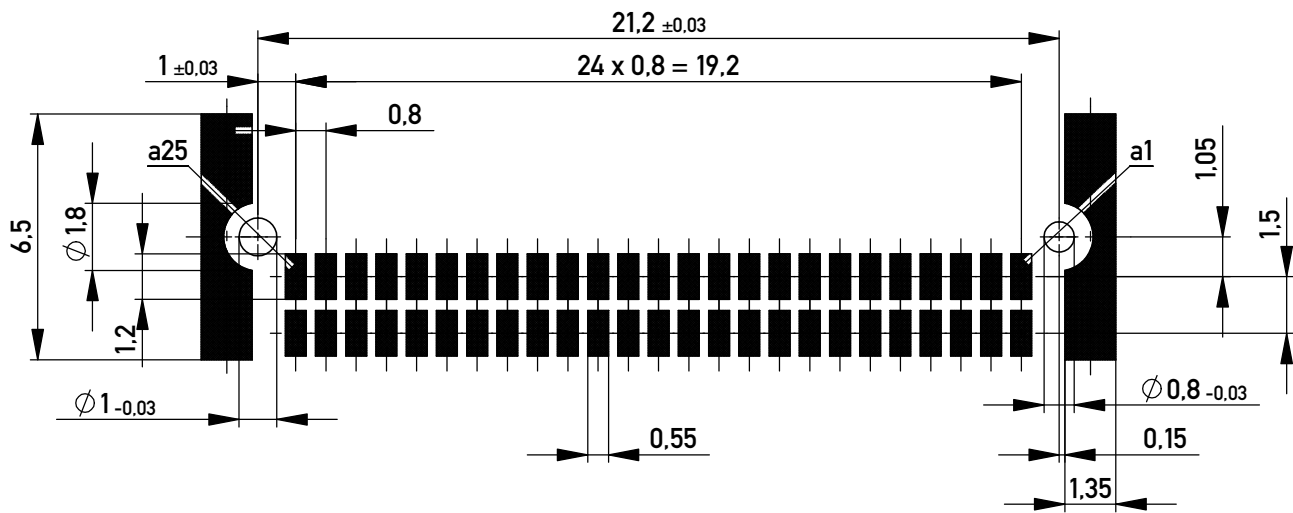

Anforderungsstufe 1
Performance Level 1

Kontaktbereich vergoldet
Mating Area gold plating

Anschlussbereich verzinkt 4-6 µm
Terminal Area 4-6 µm tin plating

Koplanarität der Anschlüsse ≤ 0,1 mm
Coplanarity Area of Termination ≤ 0.1 mm

Verpackt im Gurt nach DIN IEC 60286-3
Tape on Reel Packaging according to DIN IEC 60286-3
Verpackungseinheit: 650 Stück
Packaging unit: 650 pcs

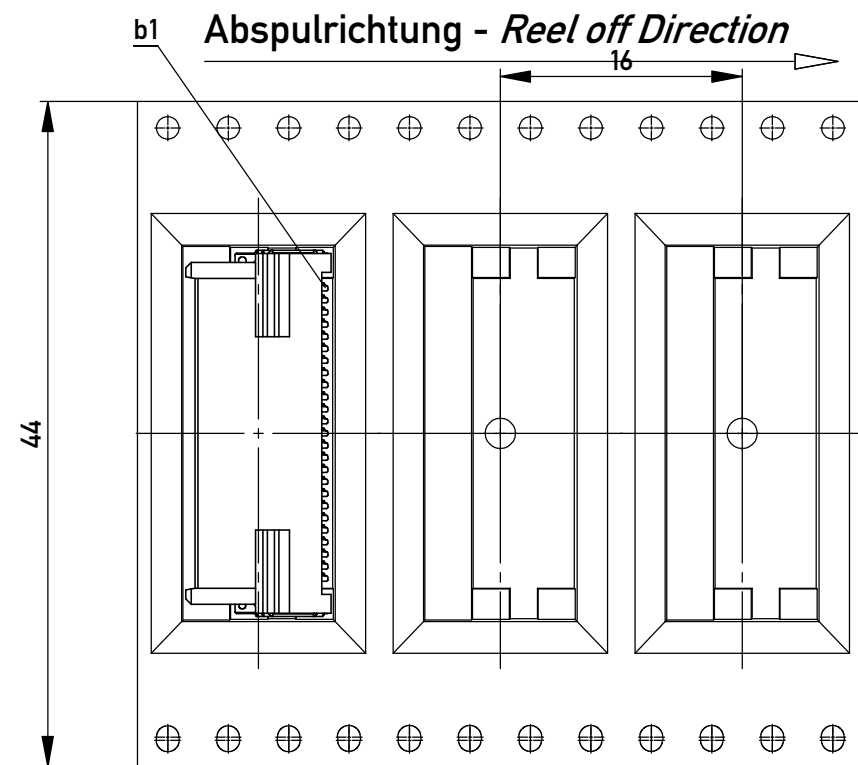
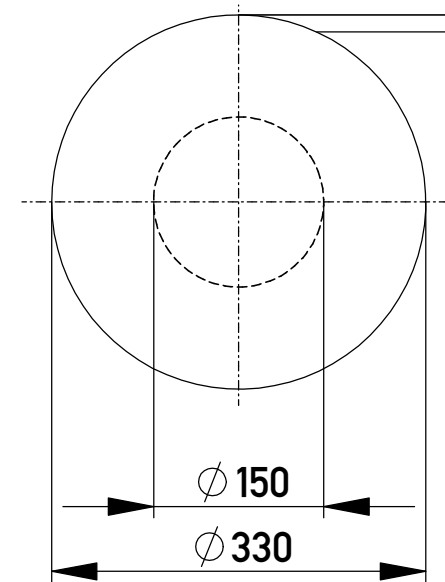

Copyright by ERNI GmbH
Proprietary notice pursuant to ISO 16016 to be observed.

Information:		Tolerances	 All Dimensions in mm	Scale	5:1
All rights reserved. Only for Information. To ensure that this is the latest version of this drawing, please contact one of the ERNI companies before using.		Subject to modification without prior notice. Drawing will not be updated.		Designation	
 www.ERNI.com		 www.ERNI.com		0,8 DRC-Q, F 50 polig 0,8 DRC-Q, F 50 pin	
a	26.02.2014			100100100005	
Index	Date			Class DRCQ	
				K A3	