

IRFSL4229PbF

Features

- Advanced Process Technology
- Low Q_G for Fast Response
- High Repetitive Peak Current Capability for Reliable Operation
- Short Fall & Rise Times for Fast Switching
- 175°C Operating Junction Temperature for Improved Ruggedness
- Repetitive Avalanche Capability for Robustness and Reliability

Key Parameters		
V_{DS} min	250	V
V_{DS} (Avalanche) typ.	300	V
$R_{DS(ON)}$ typ. @ 10V	42	mΩ
I_{RP} max @ $T_C = 100^\circ\text{C}$	91	A
T_J max	175	°C

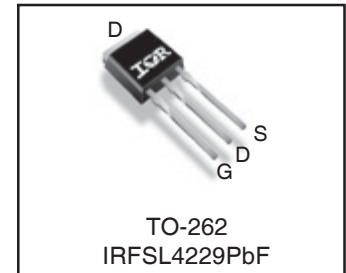
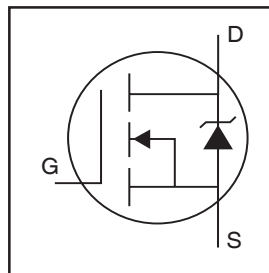

G	D	S
Gate	Drain	Source

Description

This HEXFET® Power MOSFET utilizes the latest processing techniques to achieve low on-resistance per silicon area. Additional features of this MOSFET are 175°C operating junction temperature and high repetitive peak current capability. These features combine to make this MOSFET a highly efficient, robust and reliable device.

Absolute Maximum Ratings

	Parameter	Max.	Units
V_{GS}	Gate-to-Source Voltage	±30	V
I_D @ $T_C = 25^\circ\text{C}$	Continuous Drain Current, V_{GS} @ 10V	45	A
I_D @ $T_C = 100^\circ\text{C}$	Continuous Drain Current, V_{GS} @ 10V	32	
I_{DM}	Pulsed Drain Current ①	180	
I_{RP} @ $T_C = 100^\circ\text{C}$	Repetitive Peak Current ⑤	91	
P_D @ $T_C = 25^\circ\text{C}$	Power Dissipation	330	W
P_D @ $T_C = 100^\circ\text{C}$	Power Dissipation	190	
	Linear Derating Factor	2.2	W/°C
T_J	Operating Junction and	-40 to + 175	°C
T_{STG}	Storage Temperature Range		
	Soldering Temperature for 10 seconds	300	
	Mounting Torque, 6-32 or M3 Screw	10lb·in (1.1N·m)	N

Thermal Resistance

	Parameter	Typ.	Max.	Units
$R_{\theta JC}$	Junction-to-Case ④	—	0.45*	
$R_{\theta JA}$	Junction-to-Ambient ④	—	62	

* $R_{\theta JC}$ (end of life) for TO-262 = 0.65°C/W. This is the maximum measured value after 1000 temperature cycles from -55 to 150°C and is accounted for by the physical wearout of the die attach medium.

Notes ① through ⑤ are on page 8

Electrical Characteristics @ $T_J = 25^\circ\text{C}$ (unless otherwise specified)

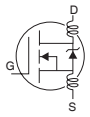
	Parameter	Min.	Typ.	Max.	Units	Conditions
BV_{DSS}	Drain-to-Source Breakdown Voltage	250	—	—	V	$V_{GS} = 0V, I_D = 250\mu A$
$\Delta BV_{DSS}/\Delta T_J$	Breakdown Voltage Temp. Coefficient	—	210	—	mV/°C	Reference to $25^\circ\text{C}, I_D = 1mA$
$R_{DS(on)}$	Static Drain-to-Source On-Resistance	—	42	48	mΩ	$V_{GS} = 10V, I_D = 26A$ ③
$V_{GS(th)}$	Gate Threshold Voltage	3.0	—	5.0	V	$V_{DS} = V_{GS}, I_D = 250\mu A$
$\Delta V_{GS(th)}/\Delta T_J$	Gate Threshold Voltage Coefficient	—	-14	—	mV/°C	
I_{DSS}	Drain-to-Source Leakage Current	—	—	20	μA	$V_{DS} = 250V, V_{GS} = 0V$
		—	—	200		$V_{DS} = 250V, V_{GS} = 0V, T_J = 125^\circ\text{C}$
I_{GSS}	Gate-to-Source Forward Leakage	—	—	100	nA	$V_{GS} = 20V$
	Gate-to-Source Reverse Leakage	—	—	-100		$V_{GS} = -20V$
g_{fs}	Forward Transconductance	83	—	—	S	$V_{DS} = 25V, I_D = 26A$
Q_g	Total Gate Charge	—	72	110	nC	$V_{DD} = 125V, I_D = 26A, V_{GS} = 10V$ ③
Q_{gd}	Gate-to-Drain Charge	—	26	—		
$t_{d(on)}$	Turn-On Delay Time	—	18	—	ns	$V_{DD} = 125V, V_{GS} = 10V$ ③ $I_D = 26A$ $R_G = 2.4\Omega$ See Fig. 22
t_r	Rise Time	—	31	—		
$t_{d(off)}$	Turn-Off Delay Time	—	30	—		
t_f	Fall Time	—	21	—		
t_{st}	Shoot Through Blocking Time	100	—	—	ns	$V_{DD} = 200V, V_{GS} = 15V, R_G = 4.7\Omega$
E_{PULSE}	Energy per Pulse	—	790	—	μJ	$L = 220nH, C = 0.3\mu F, V_{GS} = 15V$ $V_{DS} = 200V, R_G = 4.7\Omega, T_J = 25^\circ\text{C}$
		—	1390	—		$L = 220nH, C = 0.3\mu F, V_{GS} = 15V$ $V_{DS} = 200V, R_G = 4.7\Omega, T_J = 100^\circ\text{C}$
C_{iss}	Input Capacitance	—	4560	—	pF	$V_{GS} = 0V$ $V_{DS} = 25V$ $f = 1.0MHz,$ $V_{GS} = 0V, V_{DS} = 0V \text{ to } 200V$
C_{oss}	Output Capacitance	—	390	—		
C_{rss}	Reverse Transfer Capacitance	—	100	—		
$C_{oss \text{ eff.}}$	Effective Output Capacitance	—	290	—		
L_D	Internal Drain Inductance	—	4.5	—	nH	Between lead, and center of die contact 
L_S	Internal Source Inductance	—	7.5	—		

Avalanche Characteristics

	Parameter	Typ.	Max.	Units
E_{AS}	Single Pulse Avalanche Energy ②	—	130	mJ
E_{AR}	Repetitive Avalanche Energy ①	—	33	mJ
$V_{DS(Avalanche)}$	Repetitive Avalanche Voltage ①	300	—	V
I_{AS}	Avalanche Current ②	—	26	A

Diode Characteristics

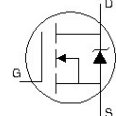
	Parameter	Min.	Typ.	Max.	Units	Conditions
$I_S @ T_C = 25^\circ\text{C}$	Continuous Source Current (Body Diode)	—	—	45	A	MOSFET symbol showing the integral reverse p-n junction diode. 
I_{SM}	Pulsed Source Current (Body Diode) ①	—	—	180		
V_{SD}	Diode Forward Voltage	—	—	1.3	V	$T_J = 25^\circ\text{C}, I_S = 26A, V_{GS} = 0V$ ③
t_{rr}	Reverse Recovery Time	—	190	290	ns	$T_J = 25^\circ\text{C}, I_F = 26A, V_{DD} = 50V$
Q_{rr}	Reverse Recovery Charge	—	840	1260	nC	$di/dt = 100A/\mu s$ ③

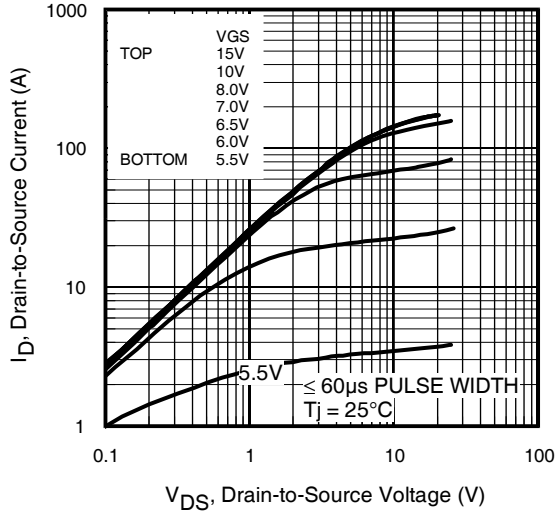

Fig 1. Typical Output Characteristics

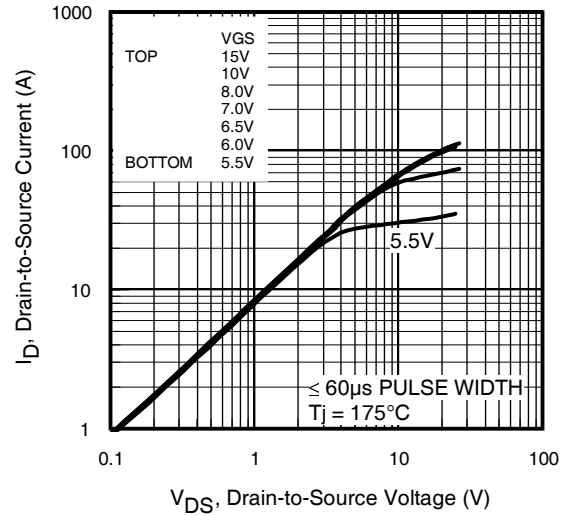

Fig 2. Typical Output Characteristics

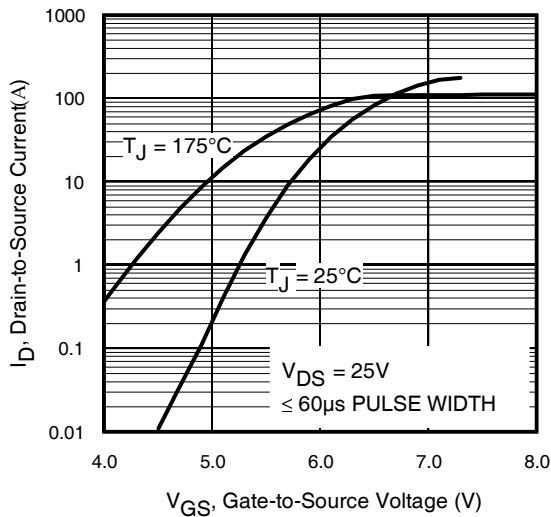

Fig 3. Typical Transfer Characteristics

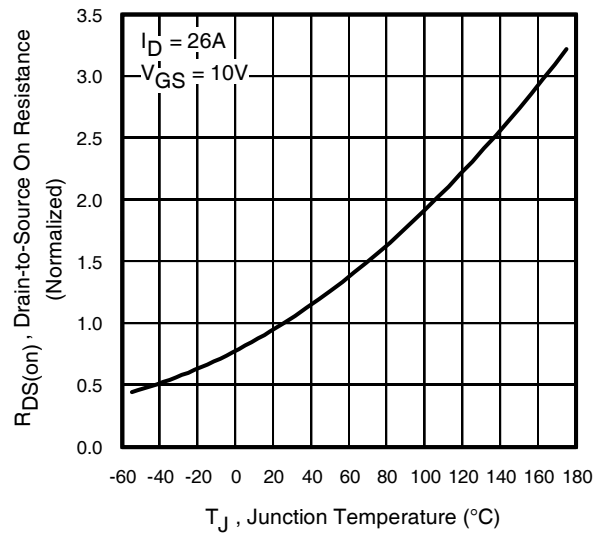

Fig 4. Normalized On-Resistance vs. Temperature

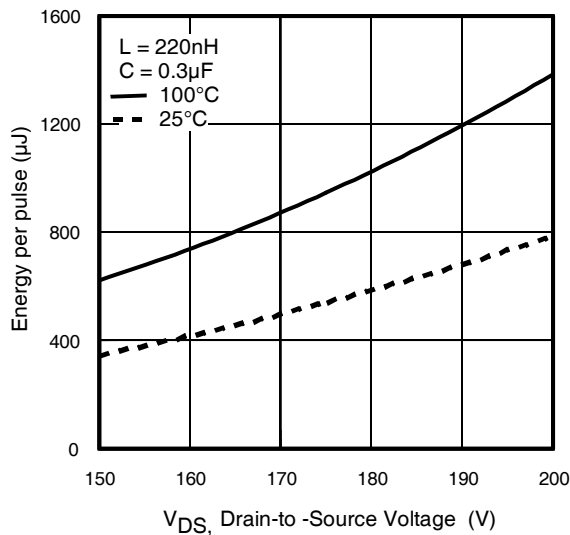

Fig 5. Typical E_{PULSE} vs. Drain-to-Source Voltage

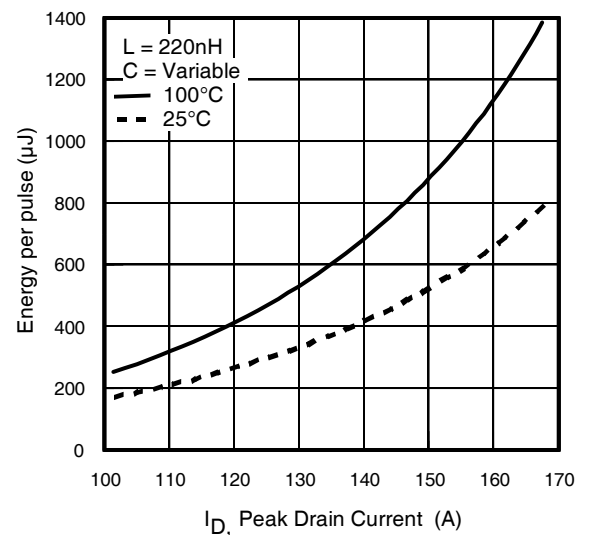

Fig 6. Typical E_{PULSE} vs. Drain Current

IRFSL4229PbF

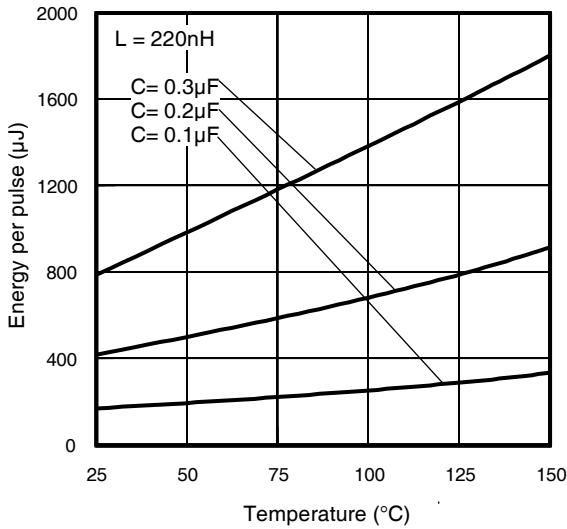

Fig 7. Typical E_{PULSE} vs. Temperature

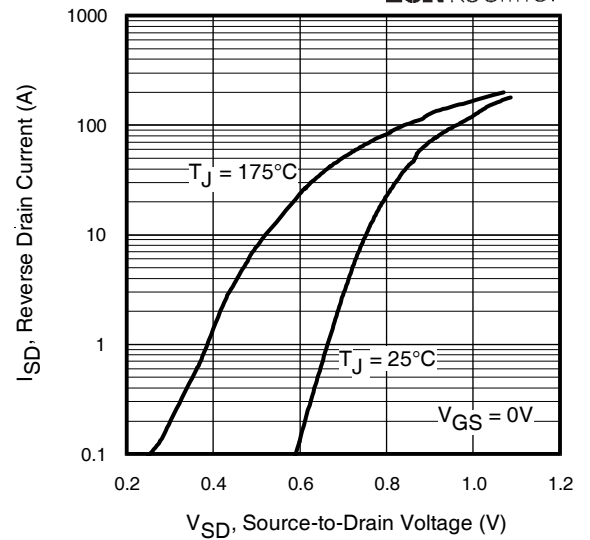

Fig 8. Typical Source-Drain Diode Forward Voltage

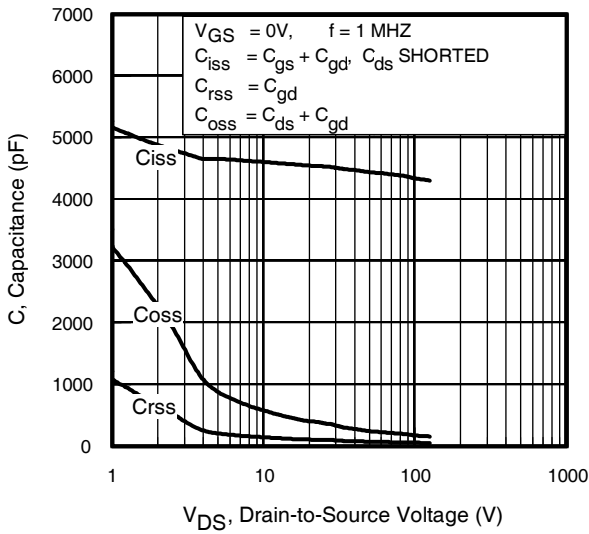

Fig 9. Typical Capacitance vs. Drain-to-Source Voltage

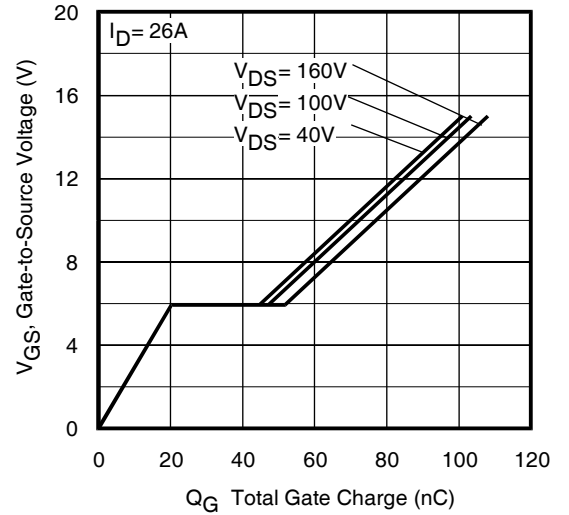

Fig 10. Typical Gate Charge vs. Gate-to-Source Voltage

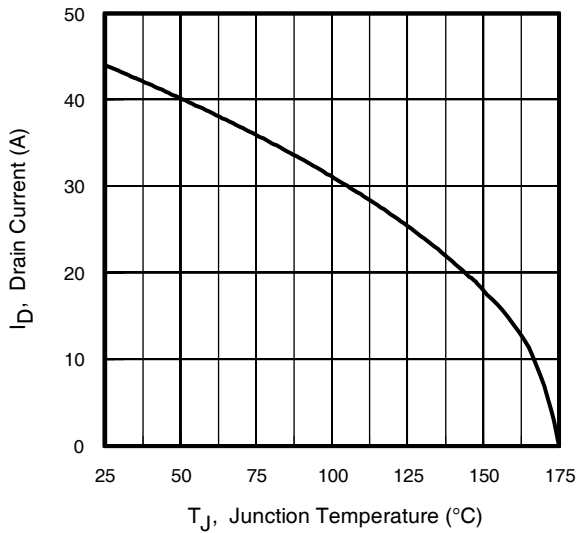

Fig 11. Maximum Drain Current vs. Case Temperature

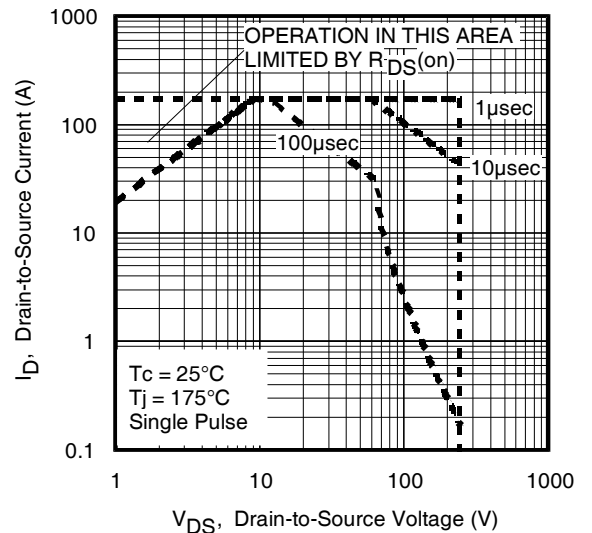

Fig 12. Maximum Safe Operating Area

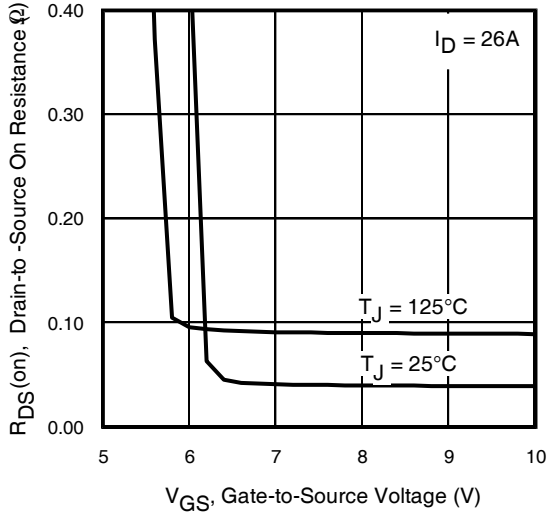

Fig 13. On-Resistance Vs. Gate Voltage

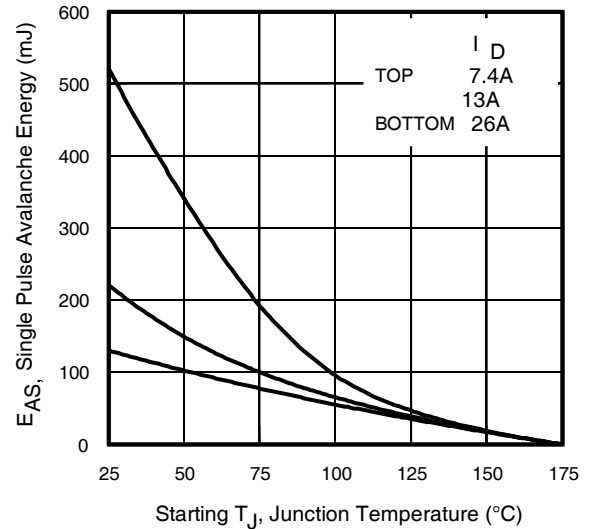

Fig 14. Maximum Avalanche Energy Vs. Temperature

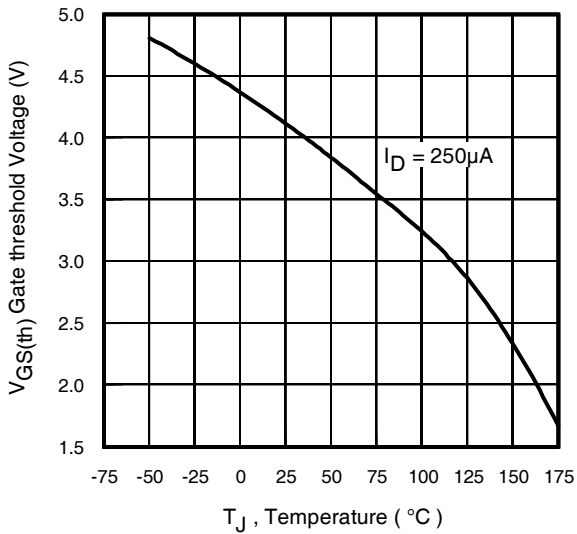

Fig 15. Threshold Voltage vs. Temperature

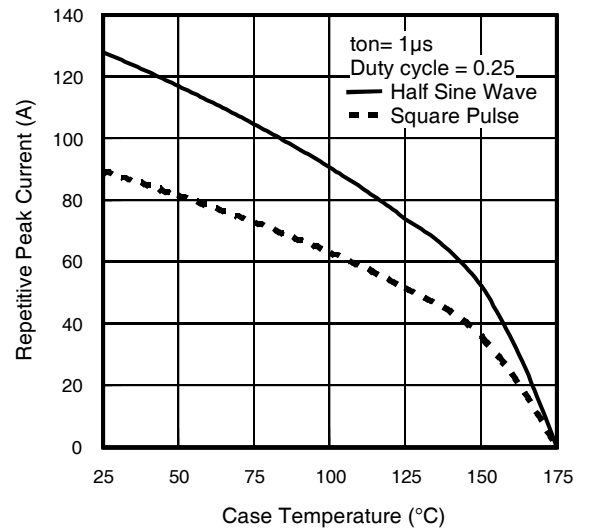

Fig 16. Typical Repetitive peak Current vs. Case temperature

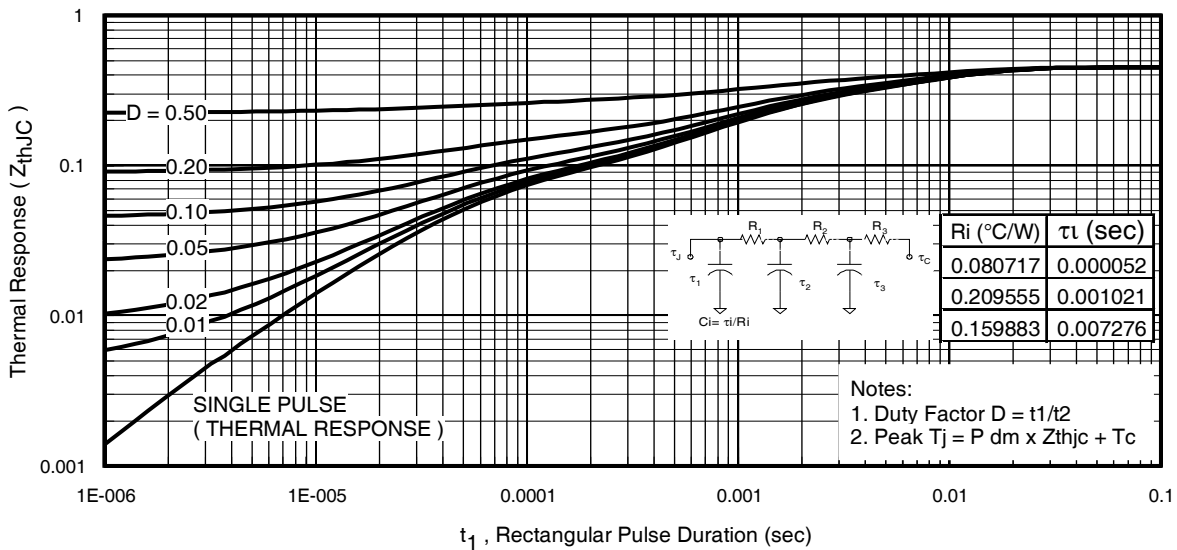

Fig 17. Maximum Effective Transient Thermal Impedance, Junction-to-Case



Fig 18. Diode Reverse Recovery Test Circuit for HEXFET® Power MOSFETs

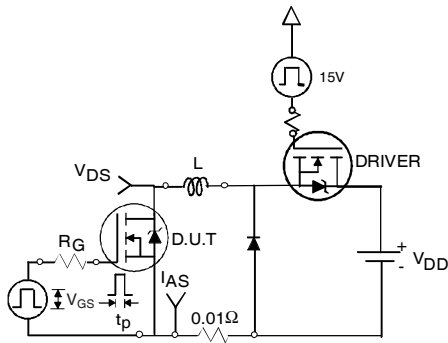

Fig 19a. Unclamped Inductive Test Circuit

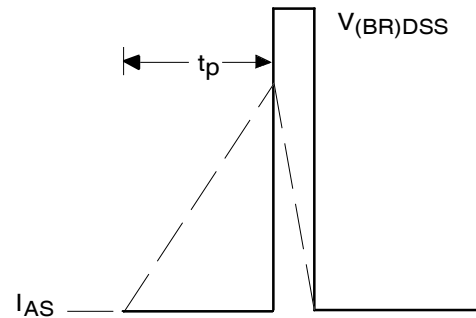

Fig 19b. Unclamped Inductive Waveforms

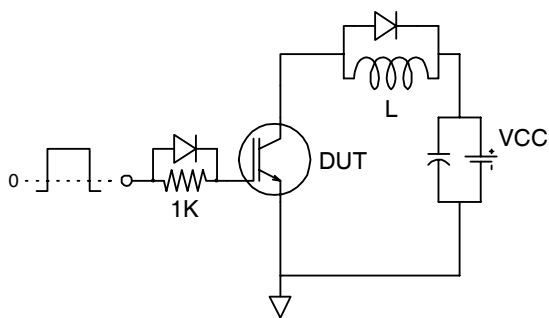

Fig 20a. Gate Charge Test Circuit



Fig 20b. Gate Charge Waveform

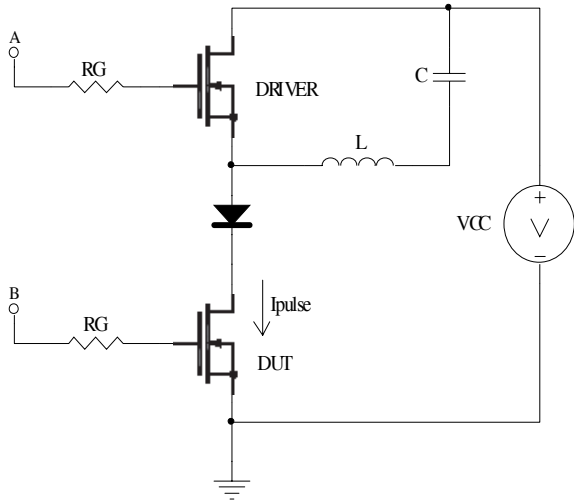

Fig 21a. t_{st} and E_{PULSE} Test Circuit

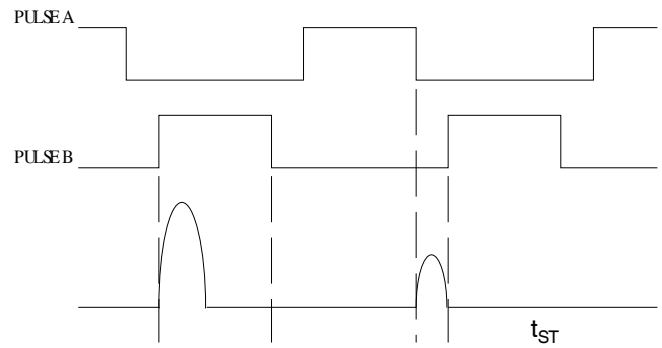

Fig 21b. t_{st} Test Waveforms

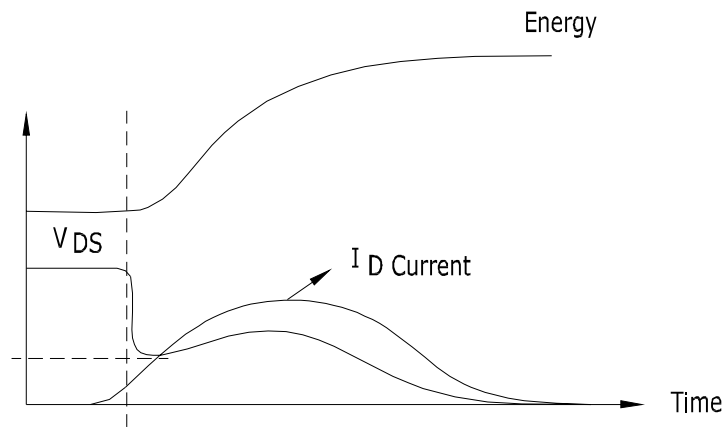

Fig 21c. E_{PULSE} Test Waveforms

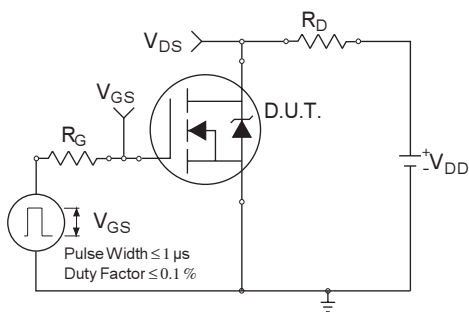

Fig 22a. Switching Time Test Circuit

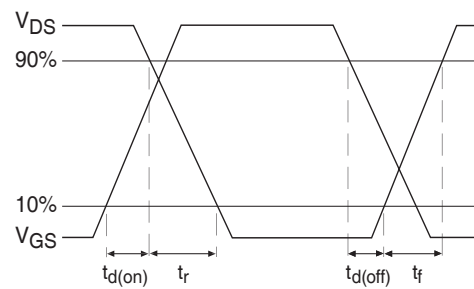
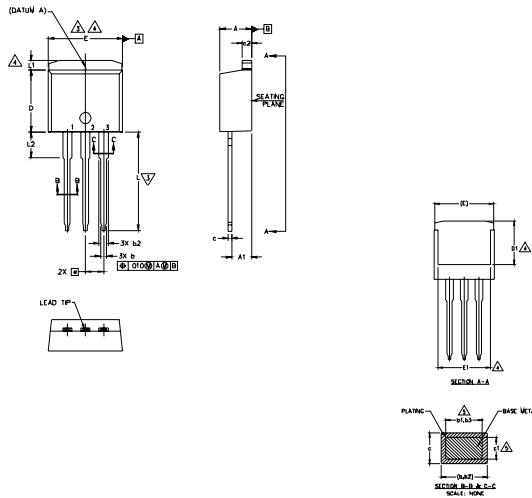

Fig 22b. Switching Time Waveforms

TO-262 Package Outline

Dimensions are shown in millimeters (inches)



- NOTES:
1. DIMENSIONING AND TOLERANCING PER ASME Y14.5M-1994
 2. DIMENSIONS ARE SHOWN IN MILLIMETERS [INCHES]
 3. DIMENSION D & E DO NOT INCLUDE MOLD FLASH. MOLD FLASH SHALL NOT EXCEED 0.127 [0.005"] PER SIDE. THESE DIMENSIONS ARE MEASURED AT THE OUTMOST EXTREMES OF THE PLASTIC BODY.
 4. THERMAL PAD CONTOUR OPTIONAL WITHIN DIMENSION E, L1, D1 & E1.
 5. DIMENSION b1 AND c1 APPLY TO BASE METAL ONLY.
 6. CONTROLLING DIMENSION: INCH.
 7. OUTLINE CONFORMS TO JEDEC TO-262 EXCEPT A1(max.), b(min.) AND D1(min.) WHERE DIMENSIONS DERIVED THE ACTUAL PACKAGE OUTLINE.

SYMBOL	DIMENSIONS				NOTES
	MILLIMETERS		INCHES		
	MIN.	MAX.	MIN.	MAX.	
A	4.08	4.83	.160	.190	
A1	2.03	3.02	.080	.119	
b	0.51	0.99	.020	.039	
b1	0.51	0.89	.020	.035	5
b2	1.14	1.78	.045	.070	
b3	1.14	1.73	.045	.068	5
c	0.38	0.74	.015	.029	
c1	0.38	0.58	.015	.023	5
c2	1.14	1.65	.045	.065	
D	8.38	9.65	.330	.380	3
D1	6.86	-	.270	-	4
E	9.65	10.67	.380	.420	3,4
E1	6.22	-	.245	-	4
e	2.54	BSC	.100	BSC	
L	13.46	14.10	.530	.555	
L1	-	1.65	-	.065	4
L2	3.56	3.71	.140	.146	

- LEAD ASSIGNMENTS**
- HEXFET**
- 1.- GATE
 - 2.- DRAIN
 - 3.- SOURCE
 - 4.- DRAIN
- IGBTs, CoPACK**
- 1.- GATE
 - 2.- COLLECTOR
 - 3.- EMITTER
 - 4.- COLLECTOR

TO-262 Part Marking Information

EXAMPLE: THIS IS AN IRL3103L
LOT CODE 1789
ASSEMBLED ON WW 19, 1997
IN THE ASSEMBLY LINE 'C'

Note: "P" in assembly line position indicates "Lead - Free"

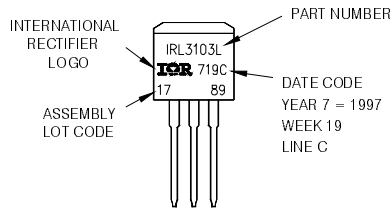

OR

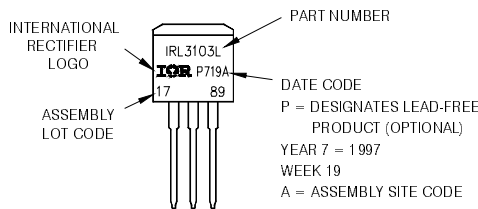

Note: For the most current drawing please refer to IR website at <http://www.irf.com/package/>

Notes:

- 1 Repetitive rating; pulse width limited by max. junction temperature.
- 2 Starting $T_J = 25^\circ\text{C}$, $L = 0.37\text{mH}$, $R_G = 25\Omega$, $I_{AS} = 26\text{A}$.
- 3 Pulse width $\leq 400\mu\text{s}$; duty cycle $\leq 2\%$.
- 4 R_θ is measured at T_J of approximately 90°C .
- 5 Half sine wave with duty cycle = 0.25, $t_{on}=1\mu\text{sec}$.

Data and specifications subject to change without notice.
This product has been designed and qualified for the Industrial market.
Qualification Standards can be found on IR's Web site.