

The RF Line NPN Silicon High-Frequency Transistors

Designed for high current low power amplifiers up to 1.0 GHz.

- Low Noise (2.0 dB @ 500 MHz)
- Low Intermodulation Distortion
- High Gain
- State-of-the-Art Technology
 - Fine Line Geometry
 - Arsenic Emitters
 - Gold Top Metallization
 - Nichrome Thin-Film Ballasting Resistors
- Excellent Dynamic Range
- Fully Characterized
- High Current-Gain Bandwidth Product
- MRF5812 available in tape and reel packaging by adding suffix:
 - R1 suffix = 500 units per reel
 - R2 suffix = 2,500 units per reel

MRF581
MRF5812R1, R2

I_C = 200 mA
LOW NOISE
HIGH-FREQUENCY
TRANSISTORS
NPN SILICON



CASE 317-01, STYLE 2
MRF581



CASE 751-06, STYLE 1
SORF (SO-8)
MRF5812

MAXIMUM RATINGS

Rating	Symbol	MRF581	MRF5812	Unit
Collector-Emitter Voltage	V _{CEO}	18	15	Vdc
Collector-Base Voltage	V _{CB0}	36	30	Vdc
Emitter-Base Voltage	V _{EBO}	2.5		Vdc
Collector Current — Continuous	I _C	200		mAdc
Thermal Resistance θ _{JC} (1)	R _{θJC}	MRF581	40	°C/W
Thermal Resistance θ _{JC} (1)	R _{θJC}	MRF5812	45	°C/W
Total Device Dissipation @ T _C = 75°C (1) Derate above T _C = 75°C	P _D	MRF581	1.88 25	Watts mW/°C
Total Device Dissipation @ T _C = 75°C (1) Derate above T _C = 75°C	P _D	MRF5812	1.67 22.2	Watts mW/°C
Storage Junction Temperature Range	T _{stg}	- 55 to +150		°C
Maximum Junction Temperature	T _{Jmax}	150		°C

DEVICE MARKING

MRF5812 = 5812

NOTE:

1. Case temperature measured on collector lead immediately adjacent to body of package.

ELECTRICAL CHARACTERISTICS ($T_A = 25^\circ\text{C}$ unless otherwise noted)

Characteristic		Symbol	Min	Typ	Max	Unit
OFF CHARACTERISTICS						
Collector–Emitter Breakdown Voltage ($I_C = 1.0\text{ mA}$, $I_B = 0$)	MRF581	$V_{(BR)CEO}$	18 15	— —	— —	Vdc
Collector–Emitter Breakdown Voltage ($I_C = 5.0\text{ mA}$, $I_B = 0$)	MRF5812	$V_{(BR)CEO}$	15	—	—	Vdc
Collector–Emitter Breakdown Voltage ($I_C = 5.0\text{ mA}$, $V_{BE} = 0$)	MRF5812	$V_{(BR)CES}$	30	—	—	Vdc
Collector–Base Breakdown Voltage ($I_C = 1.0\text{ mA}$, $I_E = 0$)	MRF581	$V_{(BR)CBO}$	36 30	— —	— —	Vdc
Emitter–Base Breakdown Voltage ($I_E = 0.1\text{ mA}$, $I_C = 0$)	MRF581 MRF5812	$V_{(BR)EBO}$	2.5	—	—	Vdc
Emitter Cutoff Current ($V_{EB} = 2.0\text{ Vdc}$, $V_{BE} = 0$)	MRF581	I_{EBO}	—	—	100	μAdc
Collector Cutoff Current ($V_{CB} = 15\text{ Vdc}$, $I_E = 0$)	MRF581	I_{CBO}	—	—	100	μAdc
Collector Cutoff Current ($V_{CB} = 15\text{ Vdc}$, $V_{BE} = 0$, $T_C = 25^\circ\text{C}$)	MRF5812	I_{CBO}	—	—	0.1	mAdc

ON CHARACTERISTICS

DC Current Gain (1) ($I_C = 50\text{ mA}$, $V_{CE} = 5.0\text{ Vdc}$)	MRF581	h_{FE}	50	—	200	—
DC Current Gain (1) ($I_C = 50\text{ mA}$, $V_{CE} = 5.0\text{ Vdc}$)	MRF5812	h_{FE}	30	90	200	—

DYNAMIC CHARACTERISTICS

Collector–Base Capacitance ($V_{CB} = 10\text{ Vdc}$, $I_E = 0$, $f = 1.0\text{ MHz}$)	MRF581	C_{ob}	—	1.4	2.0	pF
Collector–Base Capacitance ($V_{CB} = 10\text{ Vdc}$, $I_E = 0$, $f = 1.0\text{ MHz}$)	MRF5812	C_{cb}	—	1.2	2.0	pF
Current–Gain Bandwidth Product ($I_C = 75\text{ mA}$, $V_{CE} = 10\text{ Vdc}$, $f = 1.0\text{ GHz}$)	MRF581	f_T	—	5.0	—	GHz
Current–Gain — Bandwidth Product ($I_C = 75\text{ mA}$, $V_{CE} = 10\text{ Vdc}$, $f = 1.0\text{ GHz}$)	MRF5812	f_T	—	5.5	—	GHz

FUNCTIONAL TESTS

Noise Figure (Minimum) (Figure 11) ($I_C = 50\text{ mA}$, $V_{CE} = 10\text{ Vdc}$, $f = 0.5\text{ GHz}$)	MRF581	N_{Fmin}	—	2.0	3.0	dB
Noise Figure (Minimum) (Figure 11) ($I_C = 50\text{ mA}$, $V_{CE} = 10\text{ Vdc}$, $f = 0.5\text{ GHz}$)	MRF5812	N_{Fmin}	—	2.0	—	dB
Noise Figure (50 Ohm Insertion) ($I_C = 50\text{ mA}$, $V_{CE} = 10\text{ Vdc}$, $f = 0.5\text{ GHz}$)	MRF5812	$N_{F50\Omega}$	—	2.5	3.0	dB
Power Gain at Optimum Noise Figure ($I_C = 50\text{ mA}$, $V_{CE} = 10\text{ Vdc}$, $f = 0.5\text{ GHz}$)	MRF581	G_{NF}	13	15.5	—	dB
Insertion Gain ($I_C = 50\text{ mA}$, $V_{CE} = 10\text{ Vdc}$, $f = 0.5\text{ GHz}$)	MRF5812	$ S_{21} ^2$	13	15.5	—	dB
Maximum Unilateral Gain ($I_C = 75\text{ mA}$, $V_{CE} = 10\text{ Vdc}$, $f = 0.5\text{ GHz}$)		$G_{Umax(2)}$	—	17	—	dB
Intermodulation Distortion (3) ($V_{CE} = 10\text{ V}$, $I_C = 75\text{ mA}$, $V_{out} = +50\text{ dBmV}$)		IMD(d3)	—	–65	—	dB

NOTE:

1. 300 μs pulse on Tektronix 576 or equivalent.

$$2. G_{Umax} = \frac{|S_{21}|^2}{(1 - |S_{11}|^2)(1 - |S_{22}|^2)}$$

3. 2 Tones, $f_1 = 497\text{ MHz}$, $f_2 = 503\text{ MHz}$, 3rd Order Single Tone reference.

**TYPICAL CHARACTERISTICS
MRF581**

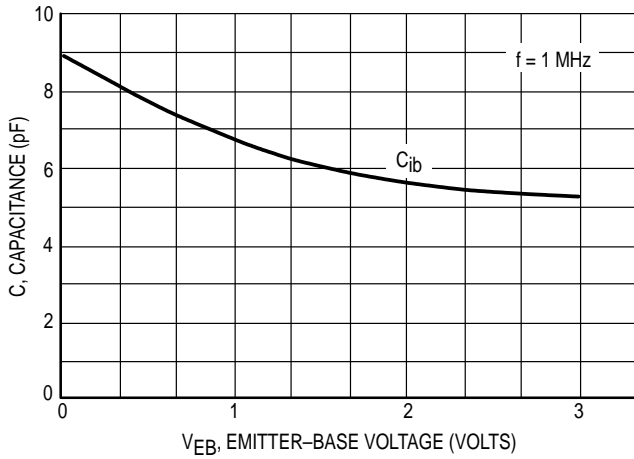

Figure 1. C_{1b} Input Capacitance versus Voltage

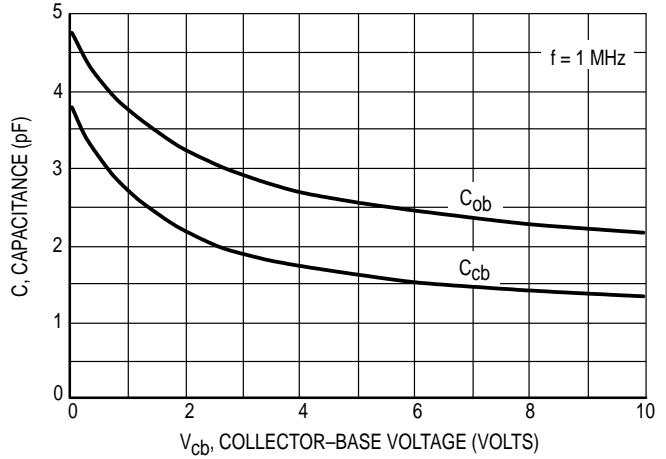

Figure 2. C_{cb} , C_{ob} Collector-Base Capacitance versus Voltage

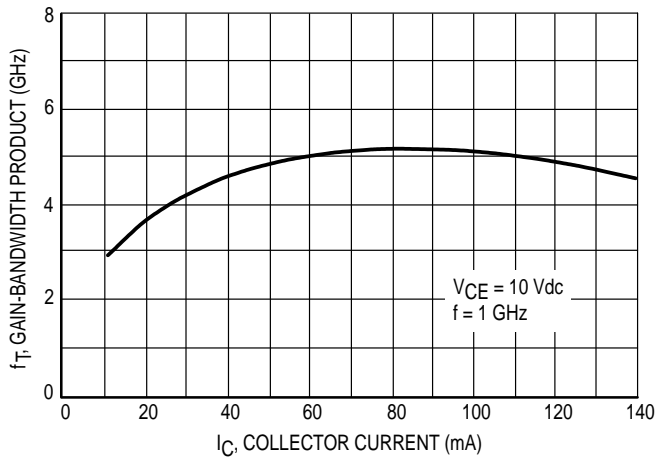

Figure 3. Gain-Bandwidth Product versus Collector Current

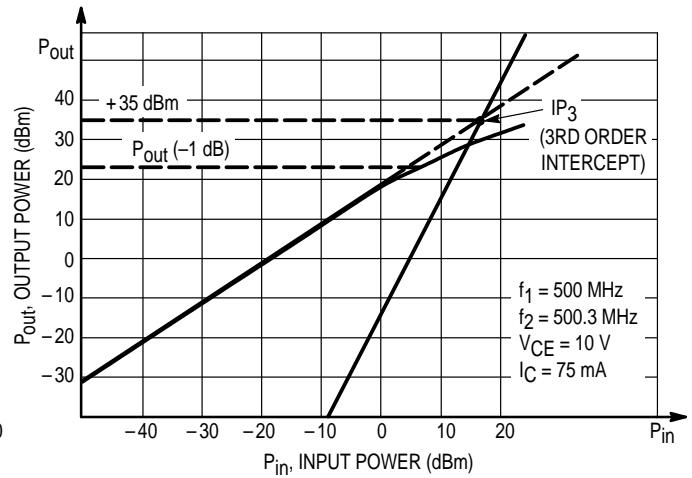

Figure 4. 3rd Order Intercept Point

TYPICAL CHARACTERISTICS MRF581

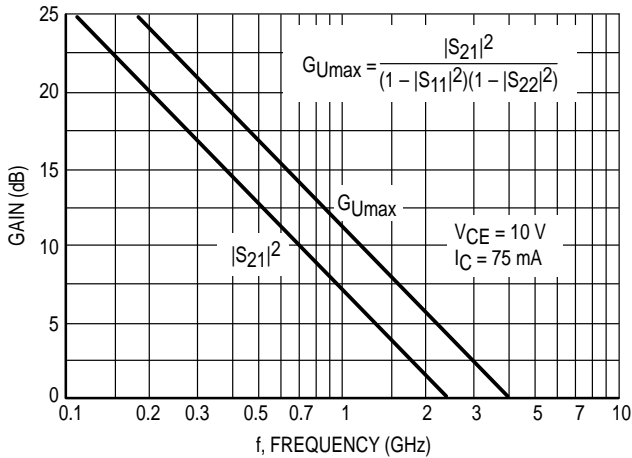

Figure 5. G_{Umax} — Maximum Unilateral Gain, $|S_{21}|^2$ versus Frequency

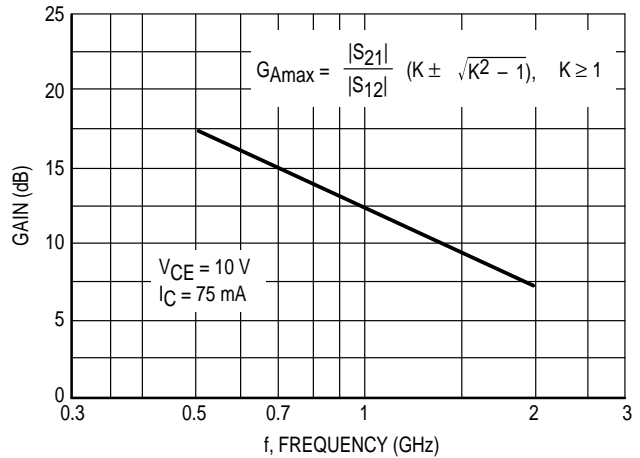

Figure 6. G_{Amax} , Maximum Available Gain versus Frequency

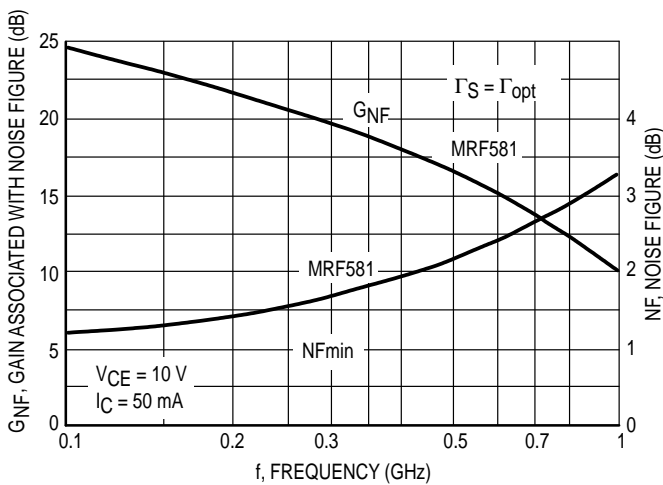

Figure 7. Minimum Noise Figure and Gain Associated with Minimum Noise Figure versus Frequency

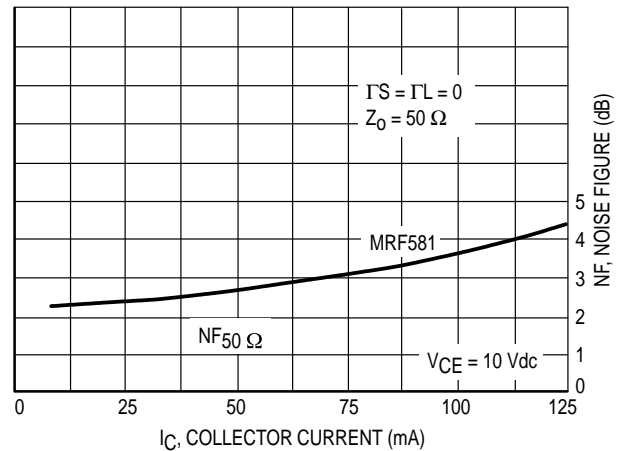

Figure 8. Noise Figure versus Collector Current $f = 500$ MHz

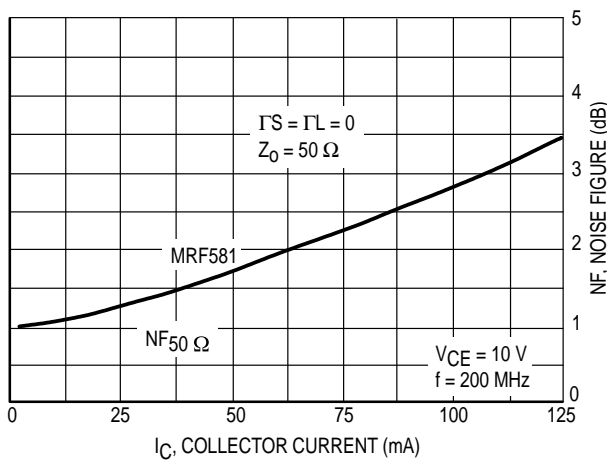

Figure 9. Noise Figure versus Collector Current

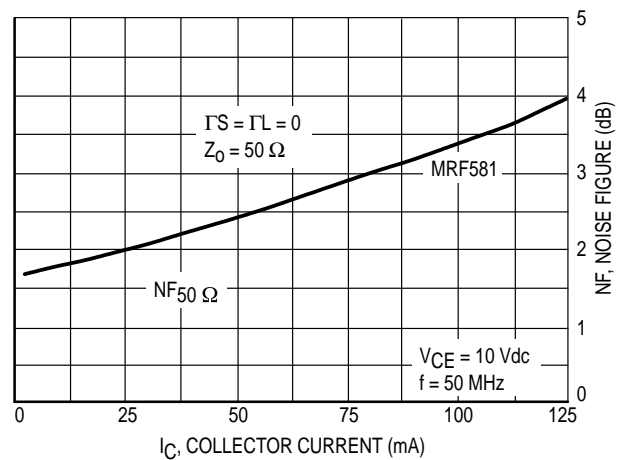

Figure 10. Noise Figure and Gain Associated with Noise Figure versus Collector Current

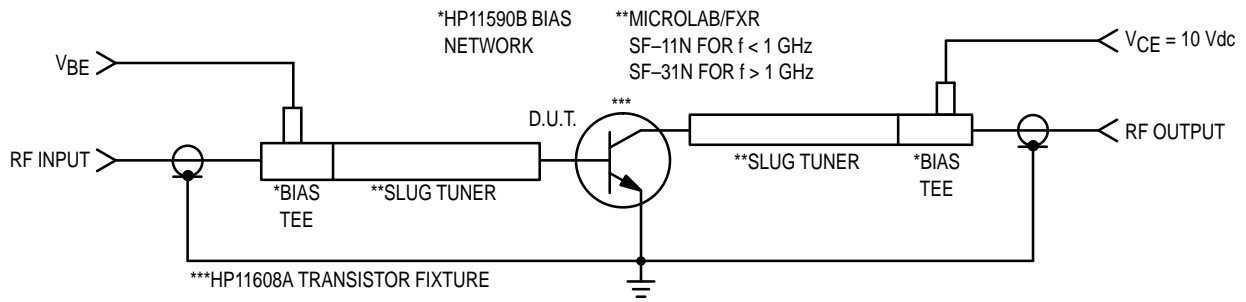

Figure 11. MRF581, MRF5812 Functional Circuit Schematic

TYPICAL CHARACTERISTICS MRF5812

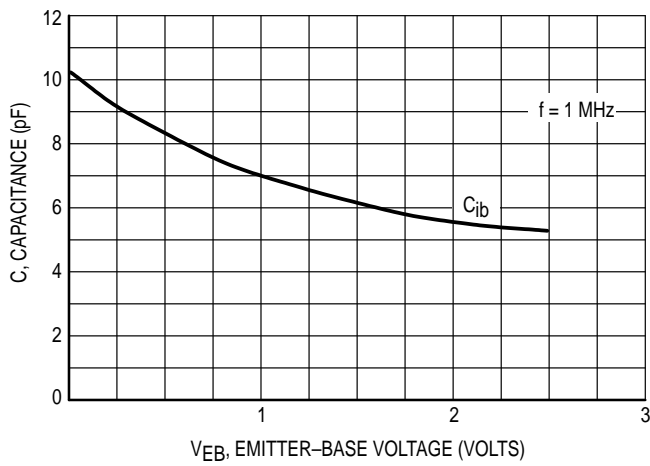

Figure 12. C_{1b} Input Capacitance versus Voltage

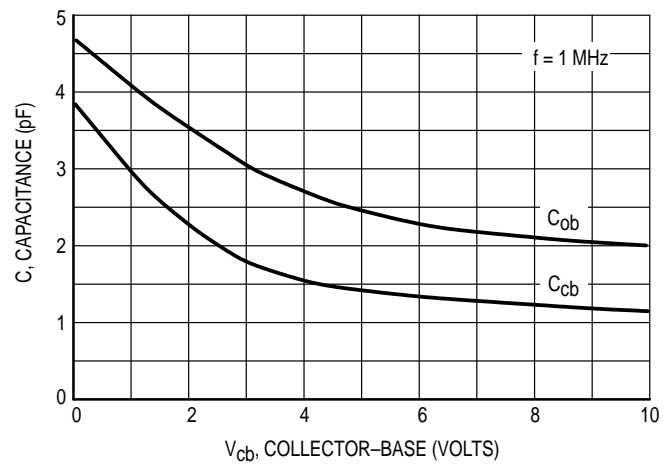

Figure 13. C_{cb} , C_{ob} Collector-Base Capacitance versus Voltage

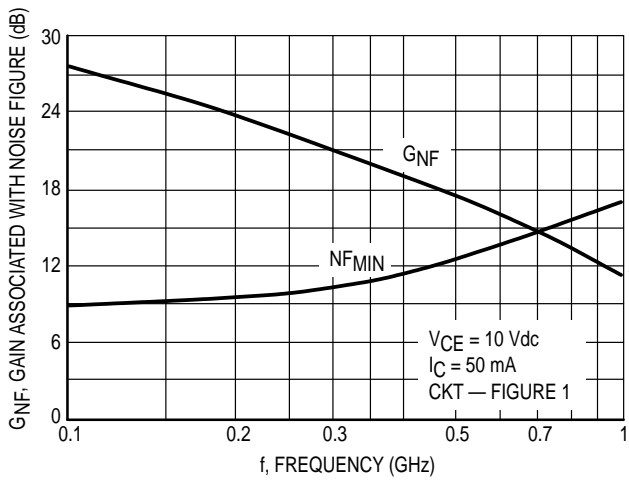

Figure 14. Minimum Noise Figure and Gain Associated with Noise Figure versus Frequency

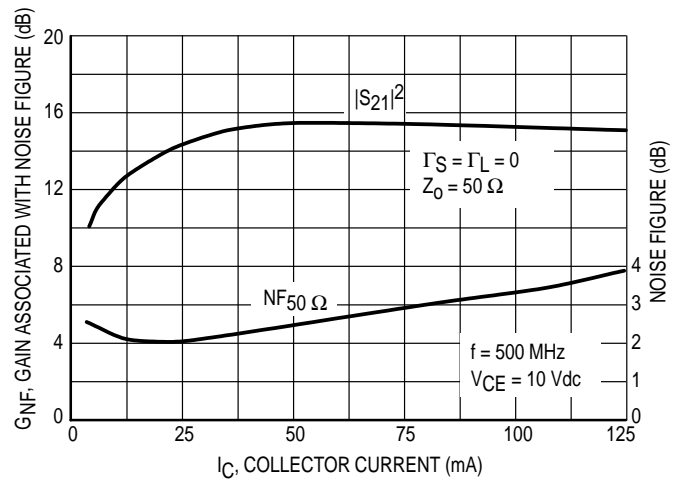

Figure 15. Noise Figure and Insertion Gain versus Collector Current

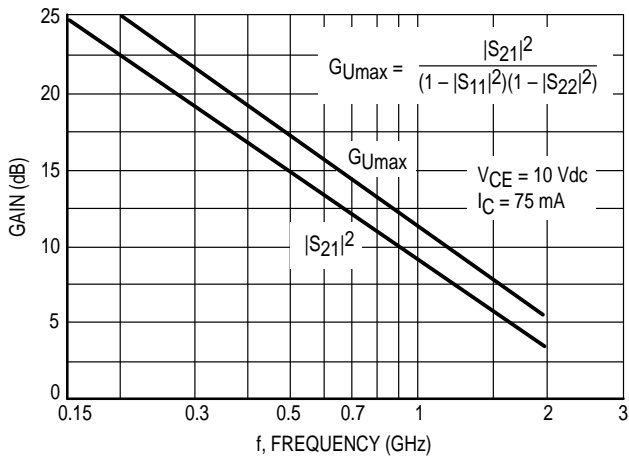

Figure 16. G_{UmAx} — Maximum Unilateral Gain, $|S_{21}|^2$ versus Frequency

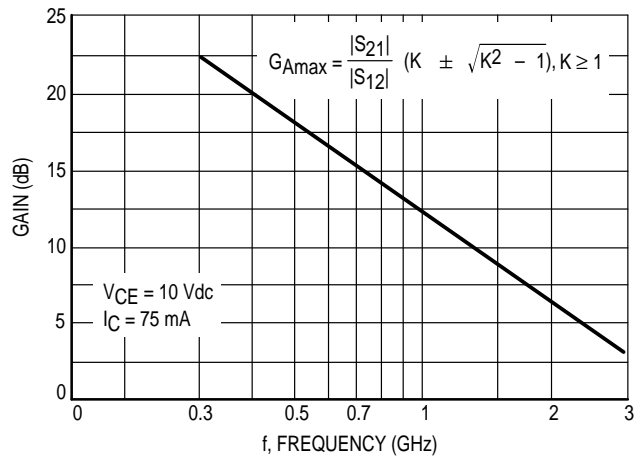

Figure 17. G_{AmAx} , Maximum Available Gain versus Frequency

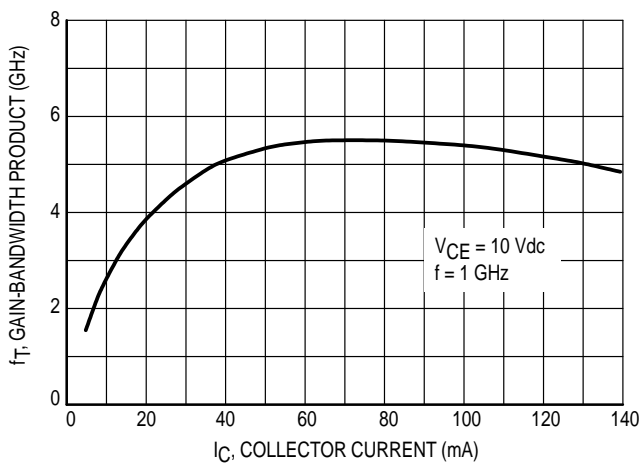

Figure 18. Gain-Bandwidth Product versus Collector Current

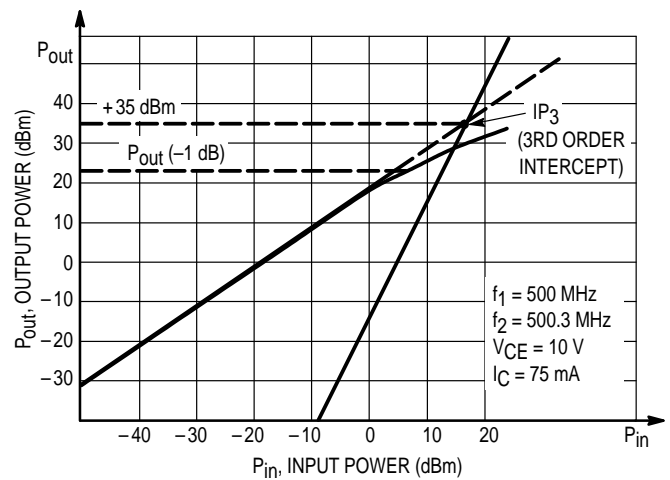

Figure 19. 3rd Order Intercept Point and 1.0 dB Compression Point

VCE = 10 V IC = 50 mA

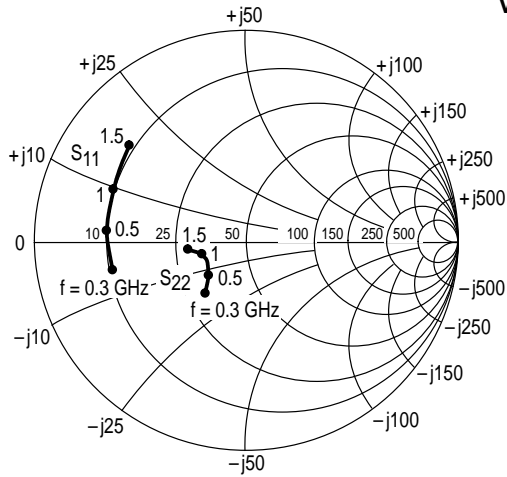

Figure 20. MRF581 Input/Output Reflection Coefficient versus Frequency

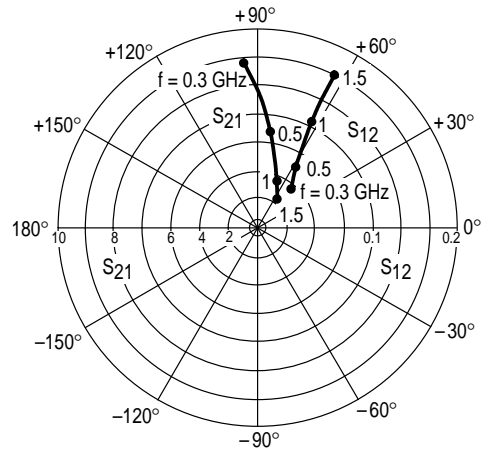

Figure 21. MRF581 Forward/Reverse Transmission Coefficients versus Frequency

VCE (Volts)	IC (mA)	f (MHz)	S11		S21		S12		S22	
			S11	∠ φ	S21	∠ φ	S12	∠ φ	S22	∠ φ
5.0	25	300	0.69	-169	6.57	93	0.06	39	0.34	-129
		500	0.72	176	3.95	82	0.07	47	0.29	-142
		1000	0.73	157	2.10	62	0.12	60	0.27	-165
		1500	0.76	139	1.47	50	0.17	61	0.33	-172
	50	300	0.70	-173	7.14	93	0.05	45	0.38	-144
		500	0.72	173	4.27	82	0.07	53	0.34	-157
		1000	0.72	157	2.24	65	0.13	62	0.33	179
		1500	0.76	138	1.61	53	0.18	61	0.37	173
	75	300	0.70	-175	7.26	92	0.05	48	0.40	-148
		500	0.72	172	4.33	82	0.07	55	0.37	-161
		1000	0.72	155	2.28	65	0.13	63	0.30	176
		1500	0.76	138	1.64	53	0.19	61	0.39	170
100	300	0.70	-176	7.30	92	0.05	48	0.40	-151	
	500	0.72	172	4.34	82	0.07	56	0.37	-163	
	1000	0.72	155	2.28	65	0.13	63	0.36	175	
	1500	0.75	137	1.64	53	0.19	61	0.39	168	
10	25	300	0.66	-165	7.58	95	0.05	40	0.29	-106
		500	0.69	178	4.56	82	0.07	48	0.23	-116
		1000	0.70	159	2.39	64	0.11	61	0.19	-141
		1500	0.74	141	1.65	50	0.16	64	0.26	-153
	50	300	0.65	-169	8.25	94	0.05	46	0.30	-126
		500	0.68	175	4.96	82	0.07	54	0.24	-138
		1000	0.69	157	2.60	65	0.12	63	0.22	-164
		1500	0.72	139	1.82	52	0.17	63	0.27	-171
	75	300	0.66	-171	8.49	93	0.05	48	0.30	-132
		500	0.68	175	5.06	82	0.07	55	0.25	-145
		1000	0.69	157	2.64	65	0.12	64	0.23	-170
		1500	0.72	139	1.86	53	0.17	63	0.27	-176
100	300	0.66	-172	8.46	93	0.05	49	0.30	-134	
	500	0.68	174	5.06	82	0.07	56	0.25	-147	
	1000	0.68	157	2.64	65	0.12	64	0.23	-172	
	1500	0.72	139	1.86	52	0.17	63	0.27	-177	
15	25	300	0.65	-163	7.96	95	0.05	40	0.28	-92
		500	0.67	179	4.82	82	0.06	48	0.21	-98
		1000	0.68	160	2.51	63	0.11	62	0.17	-119
		1500	0.72	141	1.73	49	0.16	65	0.24	-137
	50	300	0.64	-167	8.76	94	0.0	46	0.26	-112
		500	0.66	177	5.37	82	0.06	54	0.20	-122
		1000	0.67	159	2.75	65	0.11	64	0.16	-148
		1500	0.71	141	1.91	51	0.16	64	0.22	-157
	75	300	0.64	-168	8.93	93	0.05	47	0.25	-117
		500	0.66	176	5.34	82	0.06	55	0.20	-128
		1000	0.69	158	2.78	65	0.11	65	0.16	-154
		1500	0.70	140	1.93	51	0.16	64	0.22	-162
100	300	0.64	-169	8.91	93	0.05	48	0.25	-117	
	500	0.66	176	5.33	82	0.06	56	0.19	-129	
	1000	0.67	158	2.78	64	0.11	65	0.16	-154	
	1500	0.70	140	1.93	51	0.16	64	0.21	-160	

Table 1. MRF581 Common Emitter S-Parameters

V _{CE} (Volts)	I _C (mA)	f (MHz)	S ₁₁		S ₂₁		S ₁₂		S ₂₂	
			S ₁₁	∠φ	S ₂₁	∠φ	S ₁₂	∠φ	S ₂₂	∠φ
5.0	25	100	0.66	-123	18.3	118	0.04	43	0.53	-79
		300	0.66	-167	7.0	92	0.06	44	0.31	-120
		500	0.65	178	4.3	81	0.08	52	0.28	-133
		1000	0.62	154	2.2	63	0.13	61	0.28	-141
		2000	0.57	109	1.3	39	0.28	57	0.31	-148
		3000	0.55	68	1.0	23	0.41	41	0.34	-164
	50	100	0.64	-133	20.2	114	0.04	44	0.51	-93
		300	0.65	-171	7.6	91	0.06	50	0.34	-137
		500	0.65	175	4.6	81	0.08	56	0.31	-148
		1000	0.61	152	2.3	63	0.13	63	0.28	-149
		2000	0.56	109	1.3	39	0.28	57	0.30	-150
		3000	0.52	70	1.0	23	0.41	39	0.29	-169
	75	100	0.64	-137	20.8	113	0.04	44	0.50	-99
		300	0.66	-173	7.7	91	0.06	52	0.35	-142
		500	0.64	174	4.7	82	0.08	59	0.32	-154
		1000	0.61	151	2.4	65	0.14	64	0.30	-164
		2000	0.54	107	1.4	42	0.30	55	0.27	-167
		3000	0.52	69	1.1	24	0.42	37	0.25	-172
	100	100	0.64	-140	20.8	112	0.03	44	0.50	-103
		300	0.65	-174	7.6	90	0.06	53	0.36	-145
500		0.64	173	4.7	81	0.08	60	0.33	-156	
1000		0.61	151	2.4	65	0.15	64	0.31	-166	
2000		0.54	107	1.4	42	0.30	54	0.27	-169	
3000		0.52	65	1.1	24	0.42	37	0.25	-174	
10	25	100	0.65	-112	20.2	121	0.04	46	0.56	-62
		300	0.63	-162	8.0	93	0.05	46	0.29	-93
		500	0.62	-178	5.0	82	0.07	52	0.25	-102
		1000	0.60	157	2.5	63	0.11	63	0.26	-112
		2000	0.55	112	1.4	39	0.25	61	0.35	-125
		3000	0.55	69	1.0	23	0.39	47	0.40	-145
	50	100	0.63	-122	22.9	117	0.03	46	0.50	-74
		300	0.62	-167	8.8	92	0.05	51	0.28	-112
		500	0.60	178	5.3	82	0.07	58	0.24	-122
		1000	0.58	154	2.7	64	0.12	65	0.23	-129
		2000	0.51	111	1.5	40	0.26	59	0.28	-132
		3000	0.50	70	1.2	24	0.39	44	0.34	-144
	75	100	0.63	-126	23.8	116	0.03	45	0.49	-80
		300	0.63	-168	9.0	92	0.05	51	0.28	-120
		500	0.62	177	5.5	82	0.07	58	0.24	-130
		1000	0.58	154	2.8	65	0.12	65	0.23	-137
		2000	0.52	111	1.5	41	0.26	58	0.27	-135
		3000	0.50	70	1.2	24	0.39	42	0.32	-145
	100	100	0.62	-128	23.8	114	0.03	46	0.46	-82
		300	0.62	-169	8.9	91	0.05	54	0.26	-120
500		0.60	176	5.4	81	0.07	61	0.23	-130	
1000		0.57	152	2.8	64	0.12	66	0.21	-136	
2000		0.51	109	1.5	40	0.27	59	0.26	-134	
3000		0.50	68	1.2	24	0.39	43	0.32	-145	
15	25	100	0.66	-106	21	123	0.03	47	0.57	-54
		300	0.63	-159	8.5	94	0.05	46	0.30	-77
		500	0.61	-177	5.2	82	0.06	52	0.26	-84
		1000	0.58	156	2.6	62	0.11	64	0.28	-96
		2000	0.54	110	1.4	36	0.23	63	0.39	-115
		3000	0.56	68	1.0	22	0.37	49	0.46	-137
	50	100	0.62	-114	24	119	0.03	46	0.51	-64
		300	0.60	-163	9.2	93	0.05	51	0.26	-92
		500	0.58	-179	5.7	81	0.07	58	0.22	-100
		1000	0.56	154	2.9	63	0.12	66	0.23	-109
		2000	0.52	109	1.5	39	0.25	60	0.32	-118
		3000	0.52	67	1.1	22	0.37	46	0.39	-137
	75	100	0.62	-118	24.6	117	0.03	46	0.48	-67
		300	0.59	-165	9.4	92	0.05	53	0.24	-96
		500	0.58	179	5.7	81	0.07	60	0.21	-104
		1000	0.56	154	2.9	63	0.12	66	0.22	-111
		2000	0.50	109	1.5	38	0.25	60	0.31	-118
		3000	0.52	67	1.1	22	0.37	46	0.38	-136
	100	100	0.62	-121	24.8	116	0.03	46	0.46	-68
		300	0.60	-165	9.3	91	0.05	53	0.23	-96
500		0.58	179	5.7	81	0.07	61	0.20	-102	
1000		0.56	155	2.9	63	0.12	65	0.22	-109	
2000		0.50	111	1.5	39	0.25	62	0.32	-117	
3000		0.50	68	1.1	23	0.37	47	0.39	-136	

Table 2. MRF5812 Common Emitter S-Parameters

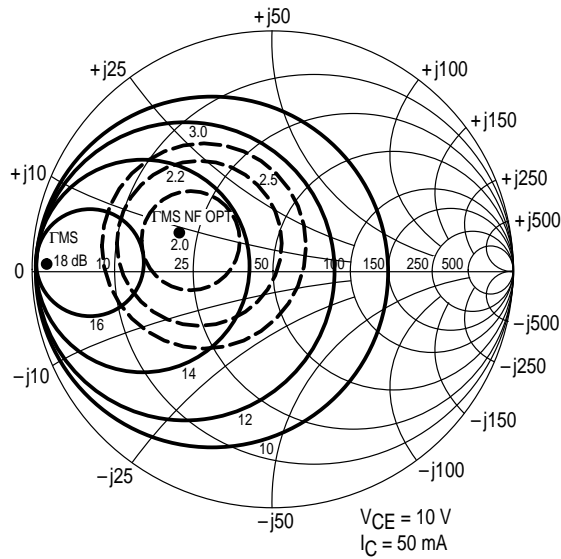

f (MHz)	Γ_{MS}	Γ_{ML}	Γ_{MS} NF OPT	$G_{A MAX}$ (dB)	R_n (Ω)	NF OPT	NF (50 Ω)
500	$0.91 \angle 176^\circ$	$0.78 \angle 77^\circ$	$0.39 \angle 159^\circ$	18	10.5	2.0	2.5

Circuit Per Figure 14

Figure 22. MRF581 Constant Gain Contours Noise Figure Contours

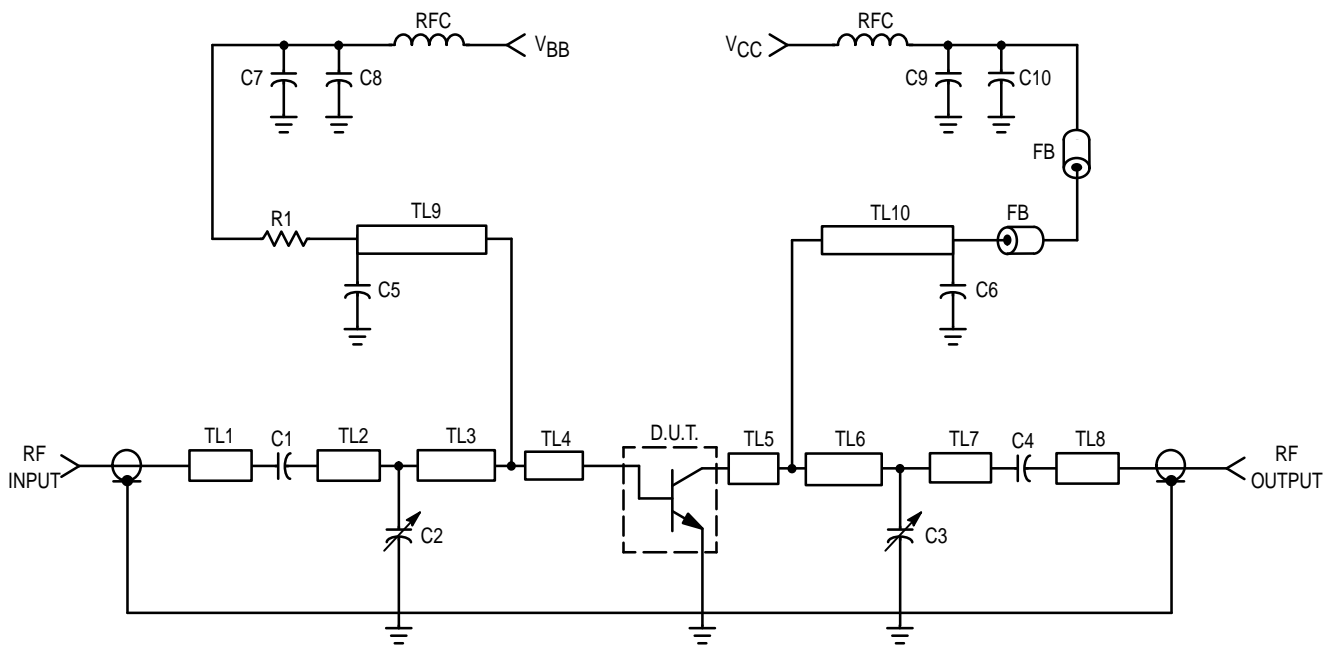

C1, C4, C5, C6, C8, C9 — 1000 pF, Chip Capacitor

C2, C3 — 1.0–10 pF, Johanson Capacitor

C7, C10 — 10 μ F, Tantalum Capacitor

R1 — 1.0 k Ω Res.

RFC — VK-200, Ferroxcube

FB — Ferrite Bead, Ferroxcube, 56–590–65/3B

Board Material — 0.0625" Thick Glass Teflon $\epsilon_r = 2.55$

TL1, TL7, TL8 — Microstrip 0.162" x 0.600"

TL2 — Microstrip 0.162" x 1.000"

TL3 — Microstrip 0.162" x 0.800"

TL4 — Microstrip 0.162" x 0.440"

TL5 — Microstrip 0.120" x 0.440"

TL6 — Microstrip 0.120" x 1.160"

TL9, TL10 — Microstrip 0.025" x 4.250"

Figure 23. MRF581 Test Fixture Schematic

PACKAGE DIMENSIONS

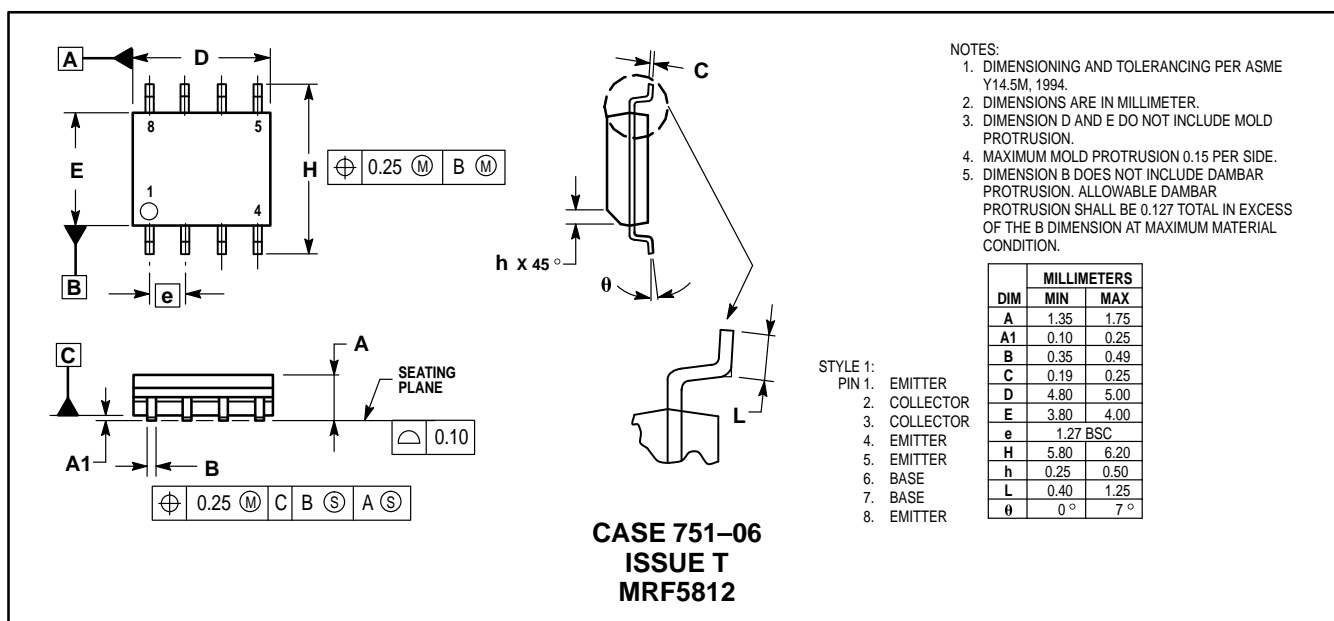
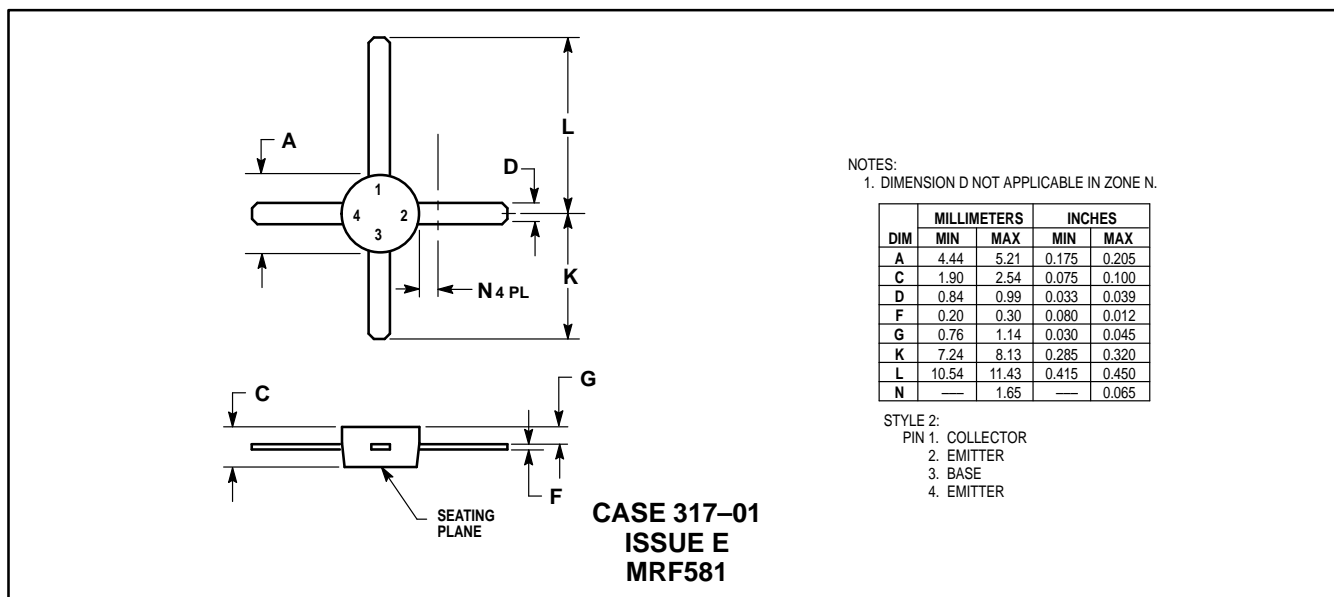

Motorola reserves the right to make changes without further notice to any products herein. Motorola makes no warranty, representation or guarantee regarding the suitability of its products for any particular purpose, nor does Motorola assume any liability arising out of the application or use of any product or circuit, and specifically disclaims any and all liability, including without limitation consequential or incidental damages. "Typical" parameters which may be provided in Motorola data sheets and/or specifications can and do vary in different applications and actual performance may vary over time. All operating parameters, including "Typicals" must be validated for each customer application by customer's technical experts. Motorola does not convey any license under its patent rights nor the rights of others. Motorola products are not designed, intended, or authorized for use as components in systems intended for surgical implant into the body, or other applications intended to support or sustain life, or for any other application in which the failure of the Motorola product could create a situation where personal injury or death may occur. Should Buyer purchase or use Motorola products for any such unintended or unauthorized application, Buyer shall indemnify and hold Motorola and its officers, employees, subsidiaries, affiliates, and distributors harmless against all claims, costs, damages, and expenses, and reasonable attorney fees arising out of, directly or indirectly, any claim of personal injury or death associated with such unintended or unauthorized use, even if such claim alleges that Motorola was negligent regarding the design or manufacture of the part. Motorola and are registered trademarks of Motorola, Inc. Motorola, Inc. is an Equal Opportunity/Affirmative Action Employer.

Mfax is a trademark of Motorola, Inc.

How to reach us:

USA/EUROPE/Locations Not Listed: Motorola Literature Distribution;
P.O. Box 5405, Denver, Colorado 80217. 1-303-675-2140 or 1-800-441-2447

JAPAN: Nippon Motorola Ltd.: SPD, Strategic Planning Office, 141,
4-32-1 Nishi-Gotanda, Shagawa-ku, Tokyo, Japan. 03-5487-8488

Customer Focus Center: 1-800-521-6274

Mfax™: RMFAX0@email.sps.mot.com – TOUCHTONE 1-602-244-6609
Motorola Fax Back System
– US & Canada ONLY 1-800-774-1848
– <http://sps.motorola.com/mfax/>

ASIA/PACIFIC: Motorola Semiconductors H.K. Ltd.; 8B Tai Ping Industrial Park,
51 Ting Kok Road, Tai Po, N.T., Hong Kong. 852-26629298

HOME PAGE: <http://motorola.com/sps/>

