

TRIAxIAL CONNECTORS FOR BROADCASTING USA STANDARD 4A SERIES



4A Series (75 Ω) for TV camera applications

For video applications LEMO offers a range of dedicated connectors adapted to US standards. Especially conceived to connect Triax television cameras to their control equipment, the 4A Series connectors are widely used by the most important

manufacturers of professional video cameras. These connectors can either be used outdoors or indoors. This Series is compatible with the Kings TRI-LOC KP80●● Series.

Technical Characteristics

Characteristics	Triax	Standard
Impedance	75 Ω	–
Operating frequency	2.5 GHz	–
VSWR (f= GHz)	1.01 + 0.076 f	IEC 60169-1-1
Contact resistance	< 3 m Ω	IEC 60512-2

Characteristics	Triax	Standard
Contact resistance internal screen	< 1 m Ω	–
Watertightness	IP61	IEC 60529
Test voltage	2 kV AC	IEC 60512-2

Recommended cables

Reference	Basic coaxial cable	Cable groupe
Belden 8232A	RG.59/U	1
Belden 9192-9232	RG.11/U	7
Belden 9267	RG.59/U	3
Belden 8233A	RG.11/U	6
Fujikura 4.8/1.0 EFTXF		2
Fujikura 9.6/2.22 EFTXF		0
GEPCO LVT 61811	RG.11/U	7
MOHAWK M52479	RG.11/U	7

Reference	Basic coaxial cable	Cable groupe
MOHAWK M80248	RG.59/U	1
MOHAWK M56301		5
DRAKA Triax 8		2
DRAKA Triax 11		5
DRAKA Triax 14		0
Triax Type A2		9
Triax Type B2		7

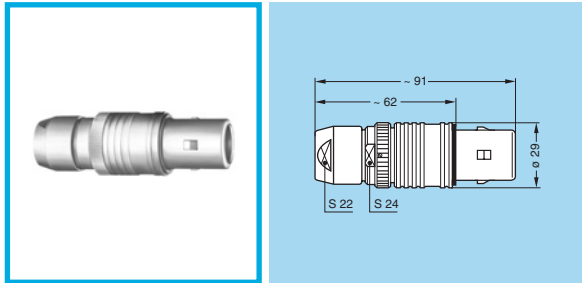

FFB, FX• Straight plug with safety ring and cable collet

Part Number	Cable groupe
FFB.4A.675.CTCC90	9
FFB.4A.675.CTCC95	3
FFB.4A.675.CTCC85	2
FFB.4A.675.CTCC97	1
FFB.4A.675.CTCC11	5
FFB.4A.675.CTCC13	7
FFB.4A.675.CTCC14	6
FFB.4A.675.CTCC16	0

Note: FFB is FFB without earthing sleeve.
FXC is FFB without earthing sleeve, without safety ring.

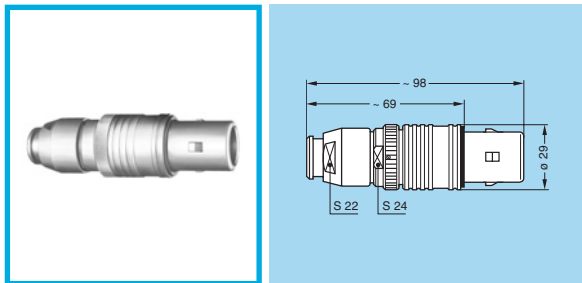

FFB, FX• Straight plug, cable collet and nut for fitting a bend relief

Part Number	Cable groupe
FFB.4A.675.CTCC90Z	9
FFB.4A.675.CTCC95Z	3
FFB.4A.675.CTCC85Z	2
FFB.4A.675.CTCC97Z	1
FFB.4A.675.CTCC11Z	5
FFB.4A.675.CTCC13Z	7
FFB.4A.675.CTCC14Z	6
FFB.4A.675.CTCC16Z	0

Note: FFB is FFB without earthing sleeve.
FXC is FFB without earthing sleeve, without safety ring.

Note:
The bend relief must be ordered separately.

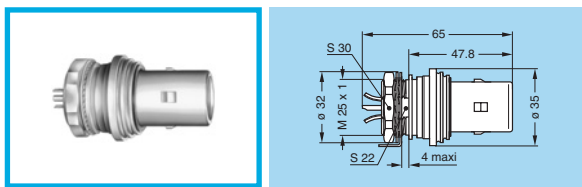

FBF, FXF Fixed plug with round flange and tag, nut fixing

Part Number	Weight (g)
FBF.4A.675.CTA	154
FXF.4A.675.CTA	154

Note:
FXF is FBF with earthing sleeve.

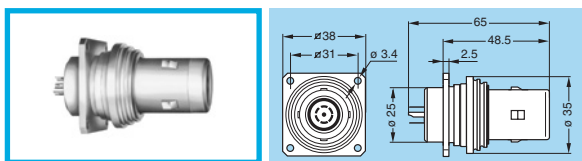

FBK Fixed plug with square flange and tag, nut fixing, with earthing sleeve

Part Number	Weight (g)
FBK.4A.675.CTA	165

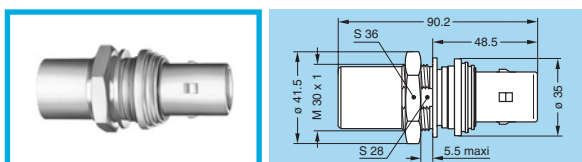

FAP Fixed coupler, nut fixing, round flange with plug and socket

Part Number	Weight (g)
FAP.4A.675.CTA	238

Note:
all dimensions are in millimetres.

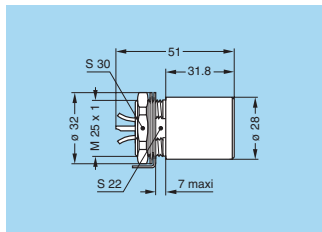

EHN Fixed socket with visible shell and tag, nut fixing

Part Number	Weight (g)
EHN.4A.675.CTL	115

Note: EXN is EHN with earthing crown

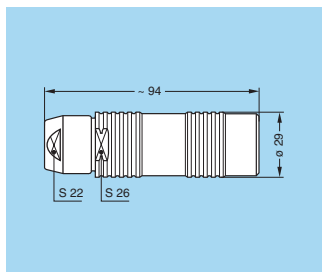
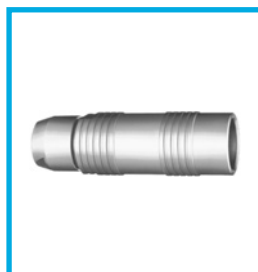

PCA Free socket with cable collet

Part Number	Cable groupe
PCA.4A.675.CTRC90	9
PCA.4A.675.CTRC95	3
PCA.4A.675.CTRC85	2
PCA.4A.675.CTRC97	1
PCA.4A.675.CTRC11	5
PCA.4A.675.CTRC13	7
PCA.4A.675.CTRC14	6
PCA.4A.675.CTRC16	0

Note: This model is also available with a nut for fitting a bend relief, add a «Z» at the end of the part number. The bend relief must be ordered separately.

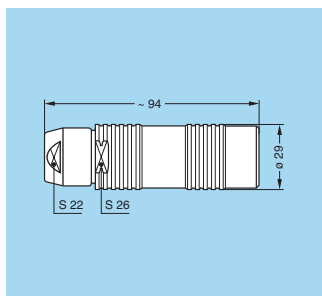
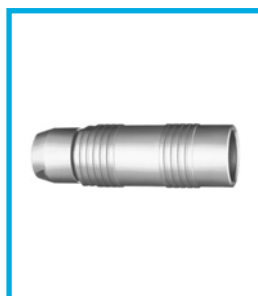

PXA Free socket with cable collet and earthing crown

Part Number	Cable groupe
PXA.4A.675.CTRC90	9
PXA.4A.675.CTRC95	3
PXA.4A.675.CTRC85	2
PXA.4A.675.CTRC97	1
PXA.4A.675.CTRC11	5
PXA.4A.675.CTRC13	7
PXA.4A.675.CTRC14	6
PXA.4A.675.CTRC16	0

Note: This model is also available with a nut for fitting a bend relief, add a «Z» at the end of the part number. The bend relief must be ordered separately.

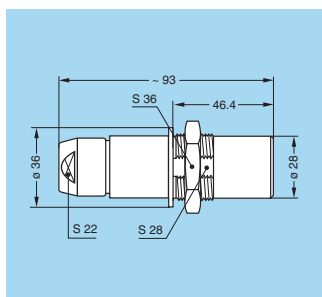
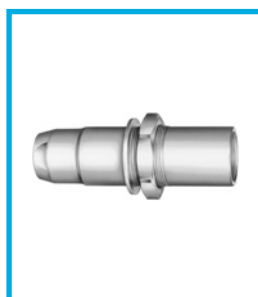

PEH Free socket, nut fixing, round flange with earthing crown

Part Number	Cable groupe
PEH.4A.675.CTRC90	9
PEH.4A.675.CTRC95	3
PEH.4A.675.CTRC85	2
PEH.4A.675.CTRC97	1
PEH.4A.675.CTRC11	5
PEH.4A.675.CTRC13	7
PEH.4A.675.CTRC14	6
PEH.4A.675.CTRC16	0

Note: This model is also available with a nut for fitting a bend relief, add a «Z» at the end of the part number. The bend relief must be ordered separately.

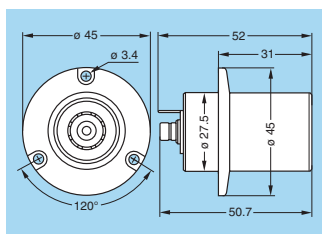
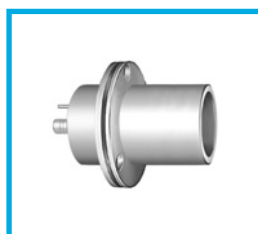

AZB Adapter, consisting of a LEMO socket and a triax SMZ socket

Part Number	Weight (g)
AZB.4A.675.CTL	133

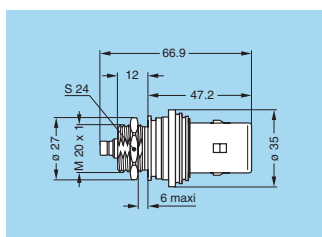

AZG Adapter, nut fixing, consisting of a LEMO socket and a triax SMZ socket

Part Number	Weight (g)
AZG.4A.675.CTA	150

Note: all dimensions are in millimetres.



Accessories

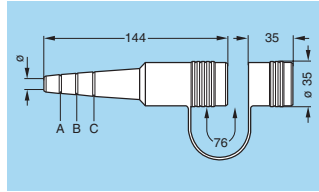

GMF Bend relief with cap for plugs

Part Number	For models
GMF.4A.080.145.NN	FFB-FXB-FXC

Note: Material: Black neoprene.
This bend relief can be used for all 4A cable groups (\varnothing min 7 mm, \varnothing max 16 mm).

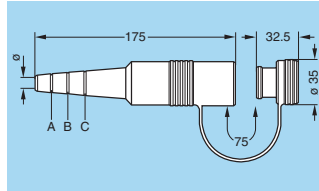
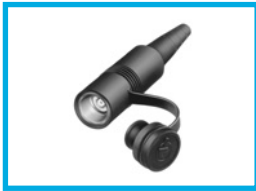

GMP Bend relief with cap for free sockets

Part Number	For models
GMP.4A.080.145.NN	PCA-PXA

Note: Material: Black neoprene.
This bend relief can be used for all 4A cable groups (\varnothing min 7 mm, \varnothing max 16 mm).

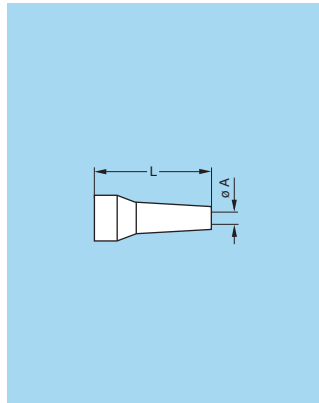

GMA Bend relief for FFB, PCA, PXA and PEH models with nut for fitting a bend relief

Part Number	Dimensions (mm)			
	Bend relief		Cable \varnothing	
	A	L	max.	min.
GMA.4B.080.DG	8.0	60	9.0	8.0
GMA.4B.010.DG	10.0	60	10.9	10.0
GMA.4B.011.DG	11.0	60	11.9	11.0
GMA.4B.012.DG	12.0	60	13.0	12.0
GMA.4B.013.DG	13.5	60	14.5	13.5

Ref.	Colour
A	blue
B	white
G	grey

Ref.	Colour
J	yellow
M	brown
N	black

Ref.	Colour
R	red
S	orange
V	green

Note:
Material: Polyurethane elastomer
Temperature range in dry atmosphere: -40°C +80°C

Note: The last letter «G» of the part number indicates the colour grey of the bend relief. For others colour, refer to the above table and replace letter «G» by the letter of the colour required.

Tooling



DPD Crimping tool

Part Number	Cable groupe
DPE.99.271.5K	1-2-3-9
DPD.99.211.2K	5-6-7
DPD.99.301.3K	0

Panel cut-outs

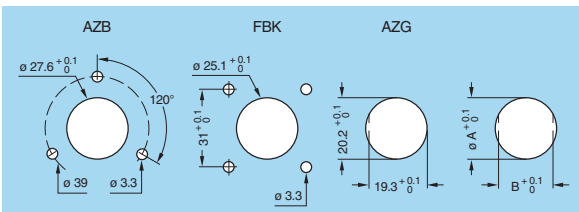

Model	Dimensions (mm)	
	A	B
EHN-EXN	26	22.5
PEH-FAP-FXP	31	28.7
FBF-FXF	26	22.2

Note: all dimensions are in millimetres.

LEMO HEADQUARTERS

SWITZERLAND
LEMO SA
Chemin des Champs-Courbes 28 - P.O. Box 194 - CH-1024 Ecublens
Tél. (+41 21) 695 16 00 - Fax (+41 21) 695 16 02 - e-mail: info@lemo.com

www.lemo.com